



THE USE OF MONOPOLY-LIKE GAME (MLG) TO PROMOTE QUALIFIED SCORES FOR THREE STUDENT COMPETENCIES

A. N. M. Fauziah*¹, A. R. Purnomo², N. Fathonah³, Khusaini^{4,5}

^{1,2,3}Science Department, Faculty of Mathematics and Natural Sciences, Universitas Negeri Surabaya

⁴University of Adelaide, Australia

⁵Physics Department, Faculty of Mathematics and Natural Sciences, Universitas Negeri Malang

DOI: 10.15294/jpii.v6i2.8183

Accepted: January 28th, 2018. Approved: August 31st, 2018. Published: September 20th, 2018

ABSTRACT

Learning ideally accommodate to not only improve cognitive competencies but also social and psychomotor as well. In fact, many practices are still lack of aforementioned concern, learning about thermal energy and its flow for instance. It focuses mainly on cognitive scores which indicate whether students can pass the exam or not. Hence, this research aimed at describing the use of MLG to promote qualified scores for competencies students have to achieve based on curriculum 2013, namely, social attitude, psychomotor and cognitive competencies altogether. In doing so, one shoot case study design was employed and involved 15 students of grade 7th. The research results showed that the students gained scores for those competencies. Each of which was 3.50 – 3.85, 3.60 – 4.00, and 3.60 – 3.80 respectively. As such, it indicated that the game was successfully promoting qualifying scores for student competencies.

© 2018 Science Education Study Program FMIPA UNNES Semarang

Keywords: monopoly-like game, student competencies, and science learning.

INTRODUCTION

Curriculum 2013 has mandated that science learning must develop knowledge and positive behaviors at the same time. The indicators for those encompass three different competencies, namely, attitude, cognitive, and psychomotor. Attitude brings about internalized characters built step by step throughout the learning process. Honesty, creativity, and feeling to be capable of are the example that can evolve using contextualized activities in the classroom (Khusniati, 2012). Machin (2014) found that having a discussion and addressing ideas will influence student attitude such as valuing other students'

opinion so as to increase the social relationship. In such a case, students can have more social access among them. Different from attitude, knowledge is about to make students understand the concepts of learning material. Richardson, Abraham, and Bond as cited in Broadbent & Poon (2015) contended that competency of knowledge is always explained in traditional view as how much score students can achieve after examination, especially when the teachers use paper-pencil test or oral test. The scores are then matched to the standard of curriculum 2013 to judge whether the students can pass or not. The third competency, psychomotor, is portrayed as the collaboration between what students think and what they do; or in other words, it stands for hands-on activities, including the way they operate laboratory apparatus (Brinson, 2015) as

*Correspondence Address

E-mail: annurilfauziah@unesa.ac.id

part of scientific method.

In fact, the mandatory to accomplish high results in three competencies encounters serious challenges when it comes to science learning. The pilot study involving 20 students in public junior high school 32 Surabaya unveiled the support to the concern. More than 65% of them asserted that learning science was categorized as difficult because they possessed a low score in their examination. This problem was assumed to link to the didactic teaching model which was implemented in the classroom. In such a case, a teacher will have a privilege to officially control students' learning behavior so as to increase student understanding towards the vast amount of material (Wang, 2011). This occurred in learning about thermal energy and its flow. In light of research, students who suffer from such a teaching model show passive attitude and their score is about no more than 64 which means below the standard, 75 (Kulsum & Hindarto, 2011). Besides, student understanding of thermal energy is limited to the high temperature and is difficult to reach an understanding of its implication in real life setting. In terms of psychomotor competencies, didactic teaching can lower student experience active collaboration between minds-on and hands-on activities when they just receive all the information from the teacher.

Many ways have been introduced to tackle the aforementioned problems ranging from collaborative learning to inquiry learning. Those have the same point, that is, the learning process must induce the students to show their active participation to construct their understanding by which entail the theory of personal and social constructivism (McInerney & McInerney 2010). This research, however, focuses mainly on bringing the value of the traditional man-made education game (MLG). This is because of two reasons. First, as far as the research about traditional education game, especially cards game, going further, it is known that most of the research is limited to only observe no more than two student competencies (Sung et al., 2013; Charlton, et al., 2005; Machin, 2012). Hence, this research stands for the support of the research that has been in a scope of three competencies.

Second, traditional game benefits to student learning. Rohwati (2012) showed that traditional game can trigger the appearance of a positive attitude and behavior such as, giving

criticism and appreciating opinion during the teacher-student discussion. Likewise, Mutiah as cited in Nur (2013) explained that science education game can guide students to increase their sensitivity towards social issue whereby they can adjust their behavior within a particular situation. Hence, this article describes the use of MLG to student learning in terms of three student competencies.

METHODS

To investigate the extent to which MLG benefits student learning, this research used one-shot case study research design (Fraenkel et al., 2012) with MLG itself as the independent variable, whereas the students' competencies as the dependent variable. The design employed 15 students who were then divided into three heterogeneous groups. The heterogeneity of each group was basically determined by cognitive and psychomotor competencies whereby the leader of the group was the student who outperformed the others. The data were collected using two instruments. First, rubrics were employed to observe attitude and psychomotor competencies the students performed during the learning process. Second, paper and pencil test was used to record cognitive competencies after the learning process. Rubric for attitude contains three items, that is, spiritual attitude, honesty, and responsibility. The scale ranged from 4 to 1. Likewise, rubrics for psychomotor consist of 4 scale points, but the items are only two, namely, skill to generate hypothesis and make a conclusion from the data given. The data were then analyzed using descriptive manner to result in a comprehensive description about the use of MLG.

RESULTS AND DISCUSSION

The Students Played the MLG

The MLG is made based on a traditional monopoly game consists of a board game, dices, pawns and cards (question-answer cards, information cards, punishment cards, and scoreboard). The board game displays 35 boxes in which each function to support student learning academic and attitude aspects such as answering questions, evaluating answers, and making social commitments.

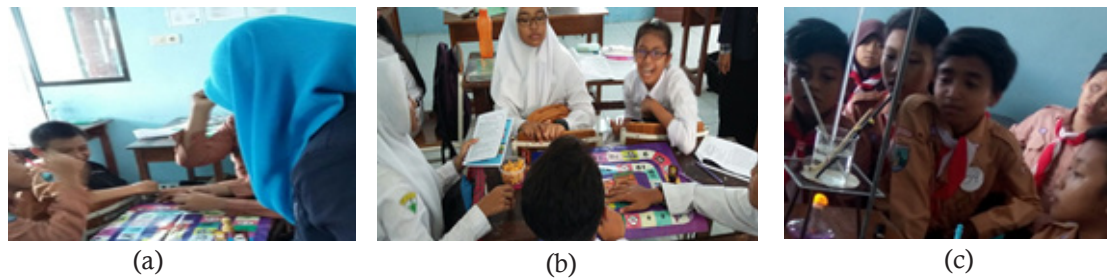


Figure 1. Process of Student Playing MLG; (a) Teacher Gave Instruction for Playing MLG; (b) Student Played the MLG and Showed Social Interaction; and (c) Student Did Experiments as Instructed in the Card of MLG to Deal with Psychomotor Competencies.

Before playing the game, the students were split into several groups of five. In each group playing, then each student did rock-paper-scissors to determine who would be in the first place to play the MLG. The MLG began when the first student rolled the dices to show how many dots to determine his steps on the board game, starting from the 'start' box to 'finish' box. When the pawn stopped to a particular box, the student-player would take a card in accordance with the box-printed instruction. If the student-player was unable to accomplish the task on the card, he could offer the task to the others. Punishment cards then were applied to those who were not capable of doing the task. For those who successfully accomplished the task, scores were rewarded. The winner was determined by the 'finish' box.

The Results of the Game in Supporting Three Competencies

The assessed learning competencies are attitude, psychomotor, and cognitive aspect. Each of which has different substances. To obtain a clear picture, each of the research results on these is described clearly in the following subsections.

Attitude Competencies

The purpose of attitude assessment in this research was to know the spiritual attitude in accordance with the Core Competency I and the social attitude of students related to the Second Core Competence during the learning of thermal energy and its flow using the MLG. The spiritual attitude recorded in the instrument was grateful for the greatness of God who has created thermal energy that can play a role in maintaining the balance of life system. The social attitudes assessed were the honesty and responsibility during the use of MLG and ther-

mal energy transfer. The honesty related to their honesty during the game and in answering the problem. The social attitude of responsibility included the responsibility in performing the game and the responsibility in utilizing the tool/board game. The following data present the results of the observation.

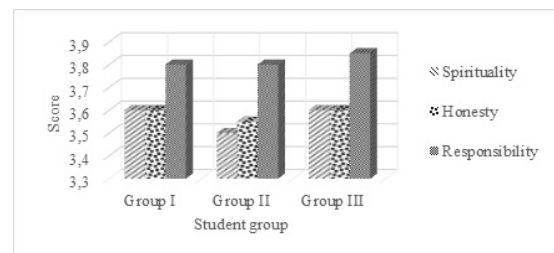


Figure 2. The Average Score Comparison of Spirituality, Honesty, And Responsibility Among Group Of Students

The diagram above shows that all groups had almost the same value in the sphere of spiritual, honest, and responsible attitude; the difference was about 0.5 to 1. In such a case, all students were categorized to be 100% completed in the spiritual aspect because all groups had succeeded in obtaining values ranging from 3.50 to 4.00. The spiritual attitude arose when the students got information about how great the God creates thermal energy and its implication in daily lives. For instance, the flow of the gas particles (wind) from the sea to the land is one of the events caused by thermal energy. Before the industrial era, all the fishermen used the wind to go home after fishing. Even today, energy from the wind is still utilized to balance the expenditure on the use of petrol. Similar to the spiritual aspect, students are also categorized as 100% complete in the honesty and responsibility aspects. The range of scores they obtained was 3.50 - 3.60 and 3.80 - 3.85 respectively. These two attitudes arose from the way the students

play MLG. The students were required to play honestly and be responsible if they got a penalty and had to accomplish the assigned duties. According to Cojuharenco et al. (2016), the emergence of a responsible attitude is triggered by the commitment or interconnection among students. In other words, all students acted as supervisors and each of them was convinced not to violate any prescribed rules or conditions. As such, until the game ended, all students could be responsible for the results they wanted to achieve.

When looking at the honesty, this attitude cannot be separated from the responsibility. Precisely, the commitment was maintained because each student kept acting honestly until the game was over. A sense of honesty could foster mutual trust so that the aim of the game was not only to win the game but also to understand the science concepts on the thermal energy and its flow. The growth of this good character is in line with the research conducted by Mulyatiningsih (2011) which asserts that games involving specific roles, such as those depicted in MLG, could foster good character in students. The specific role was that each player was accountable to himself as someone who acted to run the game as required by the rules of the game. Such an indication is shown by the figure (1.b) that the MLG provided chances to do social interaction to build good character by which the students could give social feedback to each other to support honesty and responsibility.

Psychomotor Competencies

According to Vygotsky's theory, the students could develop their psychomotor competencies if they directly interacted with one another (McInerney & McInerney 2010). Using the MLG, a group of students gave chances to its member to share information either game rules or knowledge aspect so as to enhance both social aspect and scientific skills at the same time.

The assessment of psychomotor competencies lays on the Core Competence IV National Curriculum. The psychomotor competencies in this research are limited to the skill of generating a hypothesis and conclusion based on the data of the various component effects in heat transfer. The assessment was conducted by giving the test of skills after learning process using the MLG. The result is presented in the table below.

Table 1. The Average Score of Psychomotor Competencies Among Groups of Students

Groups	Competency I	Competency II
Group I	3,6	3,8
Group II	3,8	3,8
Group III	3,6	4

The students' psychomotor competencies after playing MLG were categorized as good to pass from the curriculum standard, the scores were in the range of 3,50 - 4,00. The group 3 possessed the highest score because they were able to generate a hypothesis and conclusion in the very good criteria. The hypothesis contained the experiment variables as shown in (figure 1.c) and the conclusion extracting the essence of the data. In terms of MLG, Wasilah (2012) asserted that card game could guide students to make a better conclusion as long as the game requires students to write about the experiment concisely. This is due to the students' ability in matching the data presented in the card.

Looking at the picture below, the students enjoyed the experiment during the MLG game. They were enthusiastic to observe the data as shown in figure (1.c) which meant they followed the experimental procedure to test the hypothesis and record the data for drawing up the conclusion.

Cognitive Competencies

Cognitive competency is regarded as the ability to understand the material. The assessment is done by a paper-pencil test given. The questions are arranged based on the cognitive levels in Bloom Taxonomy from understanding level to evaluation level. Those include ten questions of multiple choice type and five essays. The result is about in the following table.

Table 2. The Average Score of Cognitive Competency among Groups of Students

Groups	Average score
Group I	3,6
Group II	3,8
Group III	3,6

Related to table 3, the students' cognitive scores on thermal energy and its flow after using MLG were in the range 2,96-3,40 and already passed the standard. The number of students achieving the standard score increased dramatically from last year which was only 65%, according to the interview with the teacher. This is in line with the research conducted by Priatmoko & Diniy (2012) that learning outcomes improve over the use of the media. The MLG provides reinforcement on the knowledge aspect by means of every end of learning, the students' knowledge competence was strengthened using the questions contained in the card. Therefore, the students' knowledge of the taught material was getting stronger and stored in long-term memory. This is consistent with Levie & Lentz (1982) statements as cited in Arsyad (2014) learning media could facilitate the purpose for understanding and remembering information.

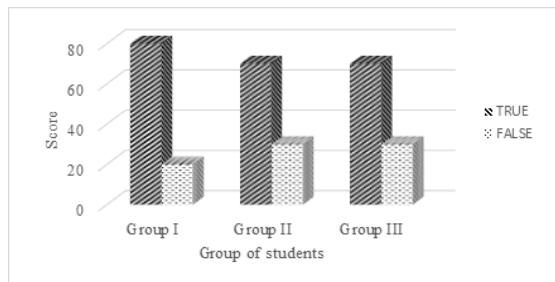


Figure 3. The Percentage of Student Answer of Multiple-Choice

The percentage of the true answer for the three groups ranged from 60 to 80%. It indicated that all groups could master the topic. The seemingly difficult questions for the students were the item 4 and 6. This was because the item 4 questioned about the temperature of the mixed components of an object and the students did not understand the calculation. Comparing to the item 4, item 6 gave a different style of question. It asked about a natural phenomenon related to thermal energy. However, the students encountered difficulties due to the biased options. Such a shortcoming seemed to happen as the students were lack of information about the questions due to time-consuming.

Although the research results have shown good indicators, two obstacles remained there. First, at the beginning of the game, the students tended to have difficulties to follow the game rules, thus, it affected the main taught materials. Second, the MLG combining learning and playing, employed a vast amount of time rather than the

time being used by the usual approach to learning. Therefore, the teacher as a learning facilitator must be able to take into account the use of this game on certain materials and the allocation of time.

CONCLUSION

The MLG played to support the students in learning the topic of thermal energy and its flow was capable to promote three competencies based on the standard of Curriculum 2013; attitude, psychomotor, and cognitive competency. There were two benefits of using the game. Firstly, the information presented on the card could promote the students to realize and recognize what the essential is. By doing so, they could manage their knowledge to understand the concepts. In addition, the students also used their skills of the scientific method to generate hypothesis and conclusion. In other words, this would affect both cognitive and psychomotor aspects at the same time. Second, the rules of the MLG set by the students could make them be honest and responsible for their role. This influenced the attitude of the students.

REFERENCES

- Arsyad, Azhar. (2014). *Media Pembelajaran*. Jakarta: Rajawali Pers.
- Brinson, J. R. (2015). Learning Outcome Achievement in Non-Traditional (Virtual and Remote) Versus Traditional (Hands-On) Laboratories: a Review of the Empirical Research. *Computers and Education*. 87(2015), 218-237.
- Broadbent, J. & W. L. Poon. (2015). Self-Regulated Learning Strategies & Academic Achievement in Online Higher Education Learning Environments: A Systematic Review. *Internet and Higher Education*. 27(2015), 1-13.
- Charlton, B., Williams, R. L., & McLaughlin, T. F. (2005). Educational Games: A Technique to Accelerate the Acquisition of Reading Skills of Children with Learning Disabilities. *International Journal of Special Education*, 20(2), 66-72.
- Cojuharenco, I., Cornelissen, G., & Karellaia, N. (2016). Yes, I can: Feeling Connected to Others Increases Perceived Effectiveness and Socially Responsible Behavior. *Journal of Environmental Psychology*, 48(2016), 75-86.
- Fraenkel, Jack R., Norman E. Wallen, & Helen H. Hyun. (2012). *How to Design and Evaluate Research in Education*. New York: McGraw-Hill.
- Khusniati, M. (2012). Pendidikan Karakter Melalui Pembelajaran IPA. *Jurnal Pendidikan IPA Indonesia*, 1(2), 204-210.

- Kulsum, K. & N. Hindarto. (2011). Penerapan Model *Learning Cycle* pada Sub Pokok Bahasan Kalor untuk Meningkatkan Keaktifan dan Hasil Belajar Siswa Kelas VII SMP. *Jurnal Pendidikan Fisika Indonesia*, 7, 128-133.
- Machin, A. (2012). Pengaruh Permainan Call Cards terhadap Hasil Belajar dan Aktivitas Pembelajaran Biologi. *Jurnal Pendidikan IPA Indonesia*, 1(2), 163-167.
- Machin, A. (2014). Implementasi Pendekatan Saintifik, Penanaman Karakter dan Konservasi Pada Pembelajaran Materi Pertumbuhan. *Jurnal Pendidikan IPA Indonesia (JPII)*, 3(1), 28-35.
- McInerney, Dennis. M. & Valentina McInerney. (2010). *Educational Psychology: Constructing Learning*. 5th Edition. New South Wales: Pearson Australia.
- Mulyatiningsih, E. (2011). Analisis Model-model Pendidikan Karakter untuk Usia Anak-anak, Remaja dan Dewasa. Yogyakarta: UNY. Retrieved from http://staff.uny.ac.id/sites/default/files/penelitian/Dra-Endang-Mulyatiningsih,-M.Pd./13B_Analisis-Model-Pendidikan-karakter.pdf
- Nur, Haerani. (2013). Membangun Karakter Anak Melalui Permainan Anak Tradisional. *Jurnal Pendidikan Karakter*. 3(1), 87-94.
- Priatmoko, S, & H.H Diniy. (2012). Penggunaan Media Sirkuit Cerdik Berbasis Chemo-Edutainment Dalam Pembelajaran Larutan Asam Basa. *Jurnal Pendidikan IPA Indonesia*, 1(1), 37-42.
- Rohwati, M. (2012). Penggunaan Education Game untuk Meningkatkan Hasil Belajar IPA Biologi Konsep Klasifikasi Makhluk Hidup. *Jurnal Pendidikan IPA Indonesia*, 1(1), 75-81.
- Sung, H. Y., & Hwang, G. J. (2013). A Collaborative Game-Based Learning Approach to Improving Students' Learning Performance in Science Courses. *Computers & Education*, 63(2013), 43-51.
- Wang, D. (2011). The Dilemma of Time: Student-Centered Teaching in the Rural Classroom in China. *Teaching and Teacher Education*, 27(1), 157-164.
- Wasilah, E. B. (2012). Peningkatan Kemampuan Menyimpulkan Hasil Praktikum IPA Melalui Penggunaan Media Kartu. *Jurnal Pendidikan IPA Indonesia*, 1(1), 82-90.



SCIENCE TEACHERS' UNDERSTANDING ON SCIENCE LITERACY AND INTEGRATED SCIENCE LEARNING: LESSON FROM TEACHERS TRAINING

B. Rubini*¹, I. D. Pusitasari², D. Ardianto³, A. Hidayat⁴

^{1,2,3}Post Graduate Science Education- Universitas Pakuan, Bogor, West Java, Indonesia

⁴Hiroshima University, Hiroshima, Japan

DOI: 10.15294/jpii.v7i3.11443

Accepted: January 31st, 2018. Approved: August 31st, 2018. Published: September 20th, 2018

ABSTRACT

One of the weaknesses of secondary science teachers today is the lack of ability to develop integrated science learning. A descriptive study, followed by a developmental research has been done to determine the factors that caused the weakness, and to find the right solution. In addition, this research involving 25 teachers as subject, has also examined how far the treatment was able to overcome the problems. The descriptive research showed that almost all of the teachers were not skillful enough to teach integrated science. This was due to the teachers' background, in which not all of them studied the integrated science education. Most of them came from biology, physics and chemistry education. They have actually attended the training (arranged by a government) on integrated science teaching, but it apparently has not succeeded. The eight steps of learning approach has been developed and implemented along the training were: (1) Building common perception on science literacy; (2) integrated science analysis based on current curriculum and lesson analysis; (3) presentation; (4) designing lesson plan in groups; (5) simulation; (6) designing lesson plan individually; (7) evaluation-reflection; and (8) rewards. After the treatment, the teacher's ability to develop the lesson plans as well as the understanding of integrated science concepts eventually improved much better. Only three teachers have to follow remedial in making lesson plan since they could not meet the requirements.

© 2018 Science Education Study Program FMIPA UNNES Semarang

Keywords: teachers' skills, integrated science, science literacy

INTRODUCTION

Science literacy is one of the entities that became the goal of science education (Sadler & Zeidler, 2009). Students that have science literacy will be able to actualize their knowledge in problem-solving through critical thinking, accompanied by positive attitudes or values (Holbrook et al., 2003). In addition, science literacy has an important role in decision making on science issues related to social life (Christenson et al., 2013). Some research results elucidated that students have difficulty in using scientific knowledge for

decision-making processes on social issues (Jho et al., 2014; Sadler, 2009; Dawson & Carson, 2016). This condition shows that scientific literacy is not inherent in students so critical thinking skills and reasoning are still weak, especially when responding to issues in daily life.

Program for International Student Assessment (PISA) showed that Indonesia received an average scientific literacy score of 403 with an average score of all 493 participants in 2015 (OECD, 2016). This data can be interpreted that Indonesian students are still weak in mastering good science as a product of knowledge or body of knowledge. Currently, science literacy is an important area studied by researchers in the field

*Correspondence Address
E-mail: bibinrubini@unpak.ac.id

of science education (Gormally et al., 2009; Setiawan et al., 2017; Fakhriyah et al., 2017; Africana et al., 2016; Ismail et al., 2016; Widiyanti et al., 2015; Putra et al., 2016; Wijayanti & Basyar, 2016; Khaeroningtyas et al., 2016; Rubini et al., 2016). Rubini et al. (2016) explored students' literacy achievement in rural and urban areas of Bogor-West Java. This study shows that the achievement of science literacy students in Bogor city is quite low, with an average of about 30% for all aspects, consisting of 29% for content, 30% for the process, and 31% for context. Rubini et al. (2016) also state that the science literacy of the teacher still low. The low of students' science literacy is caused by several factors, among others; the low science literacy of science teachers, the difficulties of science teachers in designing an integrated science learning and science learning did not accommodate the nature of science.

Some research has been conducted to develop students' science literacy, such as through a learning process that involves socioscientific issues (Sadler & Zeidler, 2009; Soobard & Rannikmae, 2011). In addition, students' science literacy can also be developed through a learning model based on constructivism (but the improvement of students' science literacy is still in the medium category (Ardianto & Rubini, 2016). These studies showed that the development of students' science literacy is an interesting study for science education practitioners. Therefore, this research tried to

examine the model of training or science professionalism of science teachers based on science literacy. This research was an attempted to answer some research questions as follows: (a) How are the science teacher's perception of science literacy and integrated science learning; (b) how is the model science teacher training based on science literacy; (c) how does the teachers' understanding about the concept of science literacy after training program; (c) how does the teachers' understanding about the concept of integrated science learning and the ability to design integrated science learning?

METHODS

This study was conducted in rural and urban areas of Bogor city, West Java. The subject was 25 science teachers selected under some criteria (undergraduate qualification from chemistry, biology, and physics education background, at least 5 years' experience as a science teacher, and has a science teacher certificate). The teacher profile included: the teacher understand to integrated science concepts, science literacy concepts, and the willingness to implement the integrated science learning based on science literacy. The research stages were composed of teacher perception surveys, training program design, and workshop. Description of the research stages appears in Table 1.

Table 1. The Research Stage

No	Stage	Description
1.	Survey	This stage aimed to explore the perceptions of science teachers about integrated science learning and scientific literacy. Researchers asked the teachers involved in the study to fill out questionnaires about their perceptions of integrated science learning and science literacy
2.	Design of teacher professional development program	In this stage, researchers developed a model for developing teacher professionalism. The process of developing the development program involved 3 researchers and 1 education expert from another university.
3.	Workshop	a. Prior to the workshop, researchers gave a pretest to participants. The pretest is done for 100 minutes. This pretest aimed to assess the teacher's understanding of integrated science learning and science literacy. The pretest was carried out before the implementation of the program. b. The workshop involved 2 experts in science education. They deliver the concept of integrated science learning and science literacy. Furthermore, in this session, the participant worked in groups to develop the design of integrated science learning and science literacy' assessment. The workshop was done in 2 sessions. Each session needed 80 minutes.

c. In the final part of the workshop, researchers gave a posttest to assess participants' understanding of the integrated science learning and science literacy after they conducted the workshop. The posttest lasted for 100 minutes. In addition to assessing the teacher's understanding, researchers also assessed the design of the lesson plan that had been prepared at the workshop stage.

RESULTS & DISCUSSION

The instruments that used in this study were the teacher perception on science literacy questioner (TPSLQ), teacher perception on integrated science learning questionnaire (TPISLQ), comprehension test on integrated science and science literacy concepts, rubrics for teachers' performance (in arranging the science lesson plan). TPSLQ and TPISLQ were used before implementing the program. The results were then used as a baseline for designing the professional teacher development program. The data were then analyzed by using qualitative as well as quantitative ways. The quantitative data analysis was performed on using inferential statistics with software IBM SPSS version-21.

Teachers' Perception on Science Literacy and Integrated Science Learning

Before attending the program, all of the science teachers were asked to fill out the questionnaires related to the understanding of the concept of integration in learning and the concept of science literacy. Teachers' perception used as a reference to develop a teacher training program. The prior information of teachers' perception has an important role in designing the training program. In line with Tapilouw et al. (2017) who stated that the training program of science teachers need to be designed according to teachers' need and prior knowledge. The teacher's understanding of both concepts is shown in Table 2.

Table 2. The Understanding of Science Teachers toward Science Literacy and Integration in Science Learning before the Training Program

No	Question	The percentage of teachers who answered (%)		
		Yes	No	Not sure
Integrated science learning concept				
1	Do you understand what the meaning of integration in science learning is?	4	20	76
2	Do you think that integration in science learning involves combining biological, chemical and physical concepts?	40	0	60
3	Have you ever applied the integrated science learning in accordance with the understanding of the concept that you believe?	12	88	
4	Have you ever attended any training related to Fogarty's integration model?		100	
5	Do you want to teach science in an integrated way?		100	
Science literacy concept				
1	Have you ever read about science literacy	60	40	
2	Do you understand profoundly the science literacy concepts?		92	8
3	Have you ever assessed the students' process skills	100		
4	Do you think the process skills are related only to physical skills?		92	8
5	Do you willing to get more information about science literacy?	100		

Two teachers believed that integrated science means integrating concepts of biology, chemistry, and physics sequentially in learning. During the interview, it revealed that most teachers had also the same perception, but they were not convinced by their thinking; so, they chose 'not sure' as their answer. Almost all teachers claimed to have never implemented the integrated science learning because they had no expertise in all three areas of science and still having difficulty in managing integrated learning. This indicated that the teachers were lack of science concept. This is in line with Fakhriyah et al. (2017) who said that pre-service teachers have difficulties in connecting science concept to other disciplines.

Overall, the key issues that should be the concern of all parties including the science teachers were: (1) the teachers' limited understanding of the integrated learning models; and (2) the committee's lack of encouragement to organize an integrated science learning process. Therefore, it resulted in less motivated teachers to implement learning consistently. It indicated that the implementation of teachers' professional development should involve school leaders. The school leaders should be integrated into the professional development program that conducted. Referring to Whitworth & Chiu (2015), school and district

leaders play a significant role in the implementation of the professional development program.

The Designed Middle Science Teacher Development Program (MSTDP)

Teacher professional development is very important because the quality of science learning depends on the teachers. Osborne & Dillon explained that the experience with no innovation would be sustained unless systematic and ongoing professional development of science teachers was provided to support the changes required in the instruction (Trna et al., 2012). The program was designed to be cyclical and could be completed for 1 semester. The program facilitated the teachers as independent learning. The strategy applied in this program was learning from the lesson (Handayani et al., 2015; Dudley, 2013; Pehmer et al., 2015; Whitworth & Chiu, 2015). Having the assumption that the teachers were independent, so, coaching was carried out by on and off methods. This consideration was taken because the teachers were bound by their duties and obligations at school. Such models were expected to be time-consuming and in line with learning activities at school. The overview of the program is presented in Figure 1.

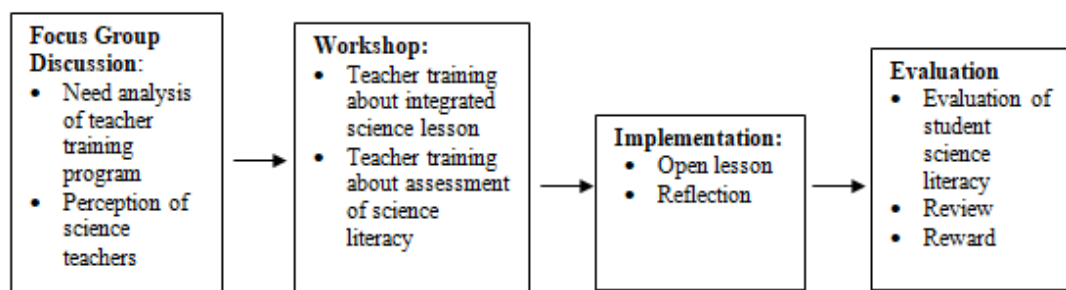


Figure 1. The Model of Teachers Professional Development Program

The program began with the FGD session to have the same perception of the integrated science learning and science literacy concepts. The earned skills were rehearsed during the open lesson and reflection session. The pre and posttest for the integrated science learning and science literacy concepts was done to observe the enhancement of teachers' understand. An assessment of the teacher's ability to design lesson plan was done at the end of the session to ensure that they were able to complete the program.

The Teachers' Understanding on Science Literacy Concept

Science teachers' understanding of the concept of science literacy was assessed by using comprehensive tests. The test was given before and after the teacher followed the training program. The results showed that there was an increase in teacher understanding of the concept of science literacy (as shown in Figure 2.)

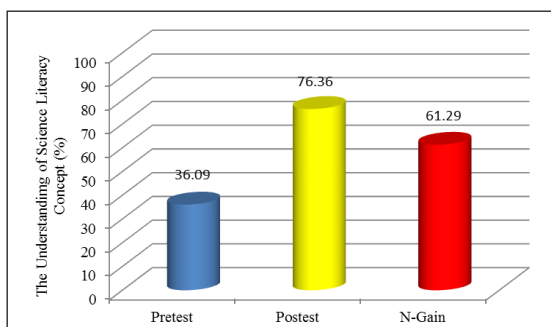


Figure 2. Science Teachers' Understanding about the Concept of Science Literacy

The scores of science teachers' concept mastery on science literacy were then tested using one sample t test. This statistical test was used to find out whether there was a significant difference in teacher understanding about the concept of science literacy before and after training. Statistical test results are shown in Table 3.

Table 3. One Sample T-test Comparing Mean Score Understanding of Science Literacy Concepts between Pretest and Posttest

	N	Mean	SD	P
Pretest	22	36.09	9.98	0.00*
Posttest	22	76.36	5.81	

* < 0.05

Table 3 informs that training programs can significantly increase teacher's insight on the concept of science literacy. The teachers' understanding of the concept of science literacy has increased by 61.29%. The existence of workshop sessions in the training program provided an understanding for teachers about the nature of science literacy and how to actualize it in teaching and learning science. Prior to training, the majority of trainees were not yet aware of the science literacy and how to actualize it. In the workshop session, teachers obtained the materials about concepts, assessment and how to actualize science literacy in a science lesson. This is parallel to Hart & Lee (2010) who stated that teachers could further elaborate and implement science literacy in learning after receiving training programs. As a result, this session provided a meaningful knowledge to the teachers about the concept of science literacy. This is in line with Anwar et al. (2012) who explained that teacher training with workshop sessions could provide an improvement to teachers' insights.

The Teacher' Understanding and Designing of Integrated Science Learning

The teacher's understanding of integrated science learning was assessed by using an essay test. The result of this research showed that before the training program the science teachers' understanding of the concept of integrated science learning was still very low (average 30,23%). Furthermore, after getting the training, the science teachers' understanding increased by 71.55% (as shown in Figure 3).

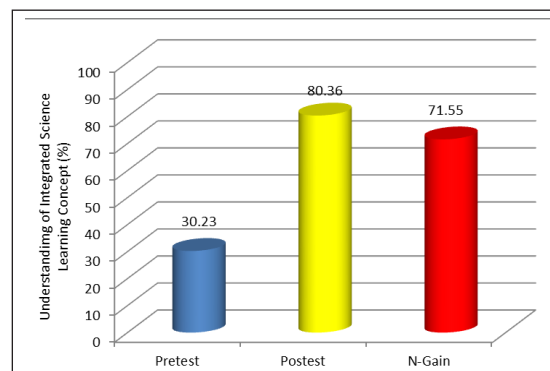


Figure 3. Science Teachers' Understanding of Integrated Science Learning

Table 4 describes that the results of statistical tests on the science teachers' understanding of integrated science learning before and after the training program. The results informed that there was a significant increase in teachers' understanding of integrated science learning (p-value < 0.05) before and after obtaining the training program.

Table 4. One Sample T-test Comparing the Mean Score Understanding of Integrated Science Learning Concepts Between the Pretest And Posttest

	N	Mean	SD	P
Pretest	22	30.22	5.22	0.00*
Posttest	22	80.36	7.75	

* < 0.05

This study also examined the skills of science teachers in designing integrated science learning based on science literacy. Teachers' skills in designing integrated science learning were assessed using teacher performance appraisal rubrics. The skills of teachers in designing integrated science learning are shown in Figure 4. The average score for teachers' skills in designing integrated science learning after training was very high

(the average score of 90). This suggested that training programs have proven to make skilled teachers in designing integrated science learning based on science literacy.

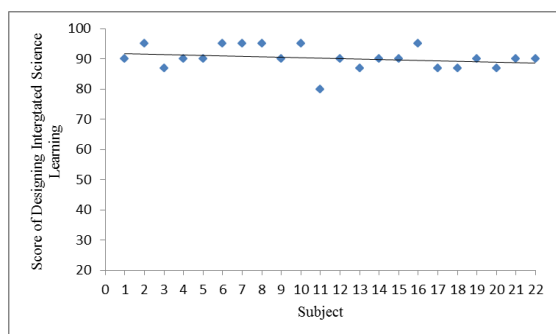


Figure 4. Teachers' Skills in Designing Integrated Science Learning after the Training Program

Based on the analysis of concepts of integrated science learning and lesson plan, the teachers did not only emphasize the integration within the science concepts. The teachers also emphasized the integration of thinking skills, concepts, and attitudes in the designed lessons plan. In addition, the teachers also elaborated the aspects of science literacy (body of knowledge, the way of thinking, the way of investigating and interaction of science, technology, and society) in the design of science learning.

This study showed that teachers made the assessment focusing on the students' science literacy. The evidence suggested that the training process with workshops and self-employment provided a more meaningful experience for the teachers. In addition, the evaluation and reflection sessions assisted the teachers in evaluating lesson plan and assessments. This is parallel to Ekanayake & Wishart (2014) who revealed that the professional development program of teachers with workshop and reflection sessions helps teachers interpret the material provided. Moreover, the training programs involving teachers, stakeholders, researchers, and practitioners of science education help the science community meet the needs of students in learning science and teachers in teaching science. Fradd et al. (2015) elucidated that the collaboration between teachers, researchers, and scientists could help improve the quality of learning in the classroom.

CONCLUSION

This study showed that training programs that covering workshops, self-employment and reflection, and evaluation provided many opportunities to develop teachers' knowledge and skills

in teaching-learning science that is in line with their nature. The collaboration between teachers, stakeholders, researchers, and education experts has helped the science community, teachers, and students improve the quality of science teaching and learning in the classroom. The training program also enhanced the teachers' knowledge of science literacy and integrated science learning concepts, as well as teachers' skills in designing integrated science learning. The teachers' knowledge of integrated science learning and literacy concept is an important asset for improving the quality of teaching and learning in the class. Science teachers' skill in designing lesson activities and assessment, while in fact, there are many teachers lacking this. Therefore, the training program needs to be done sustainably to facilitate science teachers in improving their teaching skills.

REFERENCES

- Afriana, J., Permanasari, A & Fitriani. (2016). A Project Based Learning Integrated To Stem To Enhance Elementary Schools Students Scientific Literacy. *Jurnal Pendidikan IPA Indonesia*, 5(2), 261-267.
- Anwar, Y., Rustaman, N.Y & Widodo, A. (2012). Kemampuan Subject Specific Pedagogy Calon Guru Biologi Peserta Program Pendidikan Profesional Guru (PPG) yang Berlatar Belakang *Basic Sains* Pra dan Post Workshop. *Jurnal pendidikan IPA Indonesia*, 1(2), 157-162.
- Ardianto, D & Rubini, B. (2016). Comparison of Students' Scientific Literacy in Integrated Science Learning Through Model of Guided Discovery and Problem Based Learning. *Jurnal Pendidikan IPA Indonesia*, 5(1), 31-37.
- Christenson, N., Rundgren, S.C., dan Zeidler, D.L. (2013). The Relationship of Discipline Background to Upper Secondary Student's Argumentation on Sosioscientific Issues. *Journal of Research in Science education*, 43(6), 5-12.
- Dawson, V. & Carson, K. (2016). Using Climate Change Scenarios to Assess High School Students' Argumentation Skills. *Research in Science & Technological Education*, 35(1), 1-16.
- Dudley P. (2013). Teacher Learning in Lesson Study: What Interaction-Level Discourse Analysis Revealed about How Teachers Utilised Imagination, Tacit Knowledge of Teaching and Fresh Evidence of Pupils Learning, to Develop Practice Knowledge and so Enhance Their Pupils' Learning. *Teaching and Teacher Education*, 34, 107-121.
- Ekanayake, S.Y & Wishart, J. (2014). Integrating Mobile Phones into Teaching and Learning: A Case Study of Teacher Training through Professional Development Workshops. *British Journal of Educational Technology*, 46(1), 173-189.

- Fakhriyah, F., Masfuah, S., Roysa, M., Rusilowati, A & Rahayu, E. S. (2017). Students Science Literacy in the Aspect of Content Science?. *Jurnal Pendidikan IPA Indonesia*, 6(1), 81-87.
- Fradd, S.H., Lee, O., Sutman, F.X & Saxton, M.K. (2015) Promoting Science Literacy with English Language Learners Through Instructional Materials Development: A Case Study. *Bilingual Research Journal: The Journal of the National Association for Bilingual Education*, 25(4), 479-501.
- Gormally, C., Brickman, P., Hallar, B., & Armstrong, N. (2009). Effects of Inquiry-Based Learning on Students' Science Literacy Skills and Confidence. *International journal for the scholarship of teaching and learning*, 3(2), 16.
- Handayani, R.D., Ryskiadi A., Machrus, A., and Acik, R. (2015). Penerapan Lesson Study untuk Meningkatkan Kemampuan Mengajar Mahasiswa Calon Guru Fisika., *Jurnal Pengajaran MIPA*, 20(1), 27-30.
- Hart, J.E & Lee, O. (2010). Teacher Professional Development to Improve the Science and Literacy Achievement of English Language Learners. *The Journal of the National Association for Bilingual Education*, 27(3), 475-501.
- Holbrook, J., Laius, A., dan Rannikmäe, M. (2003). *The Influence of Social Issue-Based Science Teaching Materials On Students' Creativity*. University of Tartu, Estonian Ministry of Education.
- Ismail, I., Permanasari, A & Setiawan, W. (2016). STEM Virtual Lab : An Alternative Practical Media to Enhance Students Scientific Literacy. *Jurnal Pendidikan IPA Indonesia*, 5(2), 239-246.
- Jho, H., Yoon, H.G. & Kim. K. (2014). The Relationship of Science Knowledge, Attitude and Decision Making on Socio-scientific Issues: The Case Study of Students' Debates on a Nuclear Power Plant in Korea. *Science and Education*, 23, 1131-1151.
- Khaeroningtyas, N., Permanasari, A & Hamidah, I. (2016). Stem Learning in Material of Temperature and Its Change to Improve Scientific Literacy of Junior High School. *Jurnal Pendidikan IPA Indonesia*, 5(1), 94-100.
- Pehmer, A.K., Gröschner, A & Seidel, T. (2015). How Teacher Professional Development Regarding Classroom Dialogue Affects Students' Higher-Order Learning. *Teaching and Teacher Education*, 47, 108-119.
- Putra, M.I.S., Widodo, W & Jatmiko, B. (2016). The Development of Guided Inquiry Science Learning Materials to Improve Science Literacy Skill of Prospective Mi Teachers. *Jurnal Pendidikan IPA Indonesia*, 5(1), 83-93.
- Rubini, B., Ardianto, D., Pursitasari, I.D & Permana, I. (2016). Identify Scientific Literacy from the Science Teachers' Perspective. *Jurnal Pendidikan IPA Indonesia*, 5(2), 299-303.
- Sadler, T.D dan Zeidler, D.L. (2009). Scientific Literacy, PISA, dan Socioscientific Discourse: A Assessment for Progressive Aims of Science Education. *Journal of science Teaching*, 1(1), 1-13.
- Sadler, T. D. (2009). Socioscientific Issues in Science Education: Labels, Reasoning, and Transfer. *Cultural Studies of Science Education*, 4(3), 697-703.
- Setiawan, B., Innatesari, D.K., Sabtiawan, W.B & Sudarmin, S. (2017). The Development of Local Wisdom-Based Natural Science Module to Improve Science Literation of Students. *Jurnal Pendidikan IPA Indonesia*, 6(1), 49-54.
- Soobard, R dan Rannikmae, M. (2011). Assessing Student's Level of Scientific Literacy Using Interdisciplinary Scenarios. *Science Education International*, 22(2), 133-144.
- Tapilouw, M. C., Firman, H., Redjeki, S & Chandra, D. T. (2017). The Importance of Training Needs' Questionnaire to Arrange Science Teacher Training Program. *Jurnal Pendidikan IPA Indonesia*, 6(1), 110-115.
- Trna, J., Trnova, E & Sibor, J. (2012). Implementation of Inquiry Based Science Education in Science Teacher Training. *Journal of educational and instructional studies in the world*. 2(4), 199-209.
- Whitworth, B.A & Chiu, J.L. (2015). Professional Development and Teacher Change: The Missing Leadership Link. *Journal Science Teacher Education*, 26, 121-137.
- Widiyanti, F., Indriyanti, D.R & Ngabekti, S. (2015). The Effectiveness of the Application of Scientific Literacy-Based Natural Science Teaching Set toward the Students Learning Activities and Outcomes on the Topic of the Interaction of Living Organism and Environment. *Jurnal Pendidikan IPA Indonesia*, 4(1), 20-24.
- Wijayanti, A & Basyar, M. A. K. (2016). The Development of Thematic Integrated E-Portfolio Media Web Blog Based to Increase the Scientific Literacy of Elementary Teacher Education Programs Student. *Jurnal Pendidikan IPA Indonesia*, 5(2), 284 - 290.



THE IMPROVEMENT OF PROBLEM-SOLVING SKILLS AND PHYSICS CONCEPT MASTERY ON TEMPERATURE AND HEAT TOPIC

J. R. Batlolona*¹, C. Baskar², M. A. Kurnaz³, M. Leasa⁴

^{1,4}Primary Teacher Education, Faculty of Teacher Training and Education, Pattimura University, Indonesia

²THDC Institute of Hydropower Engineering and Technology Tehri, Uttarakhand Technical University, Dehradun, Uttarakhand, India

³Department of Mathematics and Science Education, Faculty of Education, Kastamonu University, Turkey

DOI: 10.15294/jpii.v7i3.12432

Accepted: February 21st, 2018. Approved: August 31st, 2018. Published: September 20th, 2018

ABSTRACT

This work aimed at knowing the improvement of problem-solving and physics concept mastery by using the learning model of Hints and Peer Interaction Learning (HPIL) model. This research used embedded experimental model design, that one class could be used as a sample even though the sample size was less than 30 students. The number of the research sample was 22 students of one of the Senior High Schools in Malang. The instruments used were 25 numbers consisting of five numbers of the essay (problem-solving skill) and 20 numbers of multiple choices items (concept mastery). The data were analyzed by using paired sample t-test. The research results showed that there was an improvement in problem-solving skill from 40.68% to 74.77% and concept mastery from 0.48% to 0.72%. The result of the t-test indicated that the value of $\text{Sig}_{\text{counting}} < \text{Sig}_{\text{table}}$ ($0.00 < 0.05$); therefore, the problem-solving skills and concept mastery before and after the application of the HPIL was significantly different. The problem-solving skills required concept mastery or comprehensive knowledge from factual until metacognitive levels. Thus, teachers need to design suitable learning models to develop this basic knowledge as a foundation for developing problem-solving skills, one of them with HPIL.

© 2018 Science Education Study Program FMIPA UNNES Semarang

Keywords: problem-solving skill, concept mastery, HPIL

INTRODUCTION

Physics is one of the subjects considered difficult by the student so far. It is a modern learning which aims at making students be able to learn effectively by using their knowledge to analyze the situation regarding physics. Besides, physics is one of the science branches trying to describe how nature works; for instance, the universal law and the relationship between physical phenomena by using mathematics language (Argaw et al., 2017). Although the formulations seem

simple, the application may be a problem for the students (Leinonen, 2013a). The future challenge or the modern learning demands the students not only to master the concepts but also develop the thinking skill. One of the thinking skills that can be developed is a problem-solving skill needed in the 21st century.

The PSS is an issue highlighted in students' learning and seen as a fundamental part of science learning in the school (Gok, 2010). This is because of the close relationship of physics to the daily life in which the topic is always based on the problem (Viennot & Decamp, 2015). The PSS helps students to think, and then solve the prob-

*Correspondence Address
E-mail: johanbatlolona@gmail.com

lems based on the relevant theory and concept. Physics problem-solving effectively demands students to identify, determine, and solve the problems using logic, literature-based, and creative thinking (Hedge & Meera, 2012). The problem-solving skills consist of some skills related to each other such as reasoning, planning, and decision making (Greiff et al., 2014). The problem-solving skills require students to connect their knowledge to solve and find a solution to a certain problem (Hafizah, 2014). A solution is needed to solve a certain problem by using knowledge, capability, and understanding got by the students (Lin, 2010). In those processes, students would get a deep understanding of the topic field, knowledge construction, new understanding and they can make a decision (Rohanum, 2013). Students' success in understanding certain problem starts with building a description of the problem to find a proper solution (Stice, 2007). This case was done by interpreting a certain problem into a simpler model by summarizing the core concepts or key concepts needed to describe a certain problem.

Connecting concepts to the phenomena need concept mastery in understanding the physics concepts. Students develop the mastery of concept when they combine the new knowledge and their own understanding (Meyer & Land, 2006). In this process, the prior knowledge often collaborates with the new knowledge to build a better concept. In the physics learning process, the mastery of concept is very significant. Anderson & Krathwohl (2016) stated that by concept mastery, the students could improve their intellectual capability, solve the problem they face and find a meaningful learning. Generally, the purpose of physics learning is to make the students have the skill to be able to improve their knowledge, have skill and attitude that can be a provision to continue their study to the higher education level and develop the knowledge and technology (BSNP, 2006)

One of the physics concepts that need a concept mastery and problem-solving skills is the topic of temperature and heat. The temperature and heat topic is close to the daily life. However, students are hard to explain the phenomena scientifically. Such a topic is one of the abstract topics in physics subject learning (Zacharia et al., 2008). The topic of temperature and heat is rich in concepts correlating each other including some parts of which understanding is overlapping (Leinonen, 2013a). For example, explaining the heat as an energy moving from a certain object to another object is a result of temperature change (Young & Freedman, 2004) and connecting two

concepts namely energy and temperature. Therefore, the complete concept mastery is necessary. The students' success in mastering the concept is not about how to answer correctly and systematically but how the students understand the physical process of a certain problem (Wambugu & Changeiywo, 2008). The fact happening in the field is the learning only focuses more on the mathematics calculation than the physics concept mastery in problem-solving (Gaigher et al., 2007). When the students are low in solving the problem, they may less understand a certain topic being discussed (Minner 2010; Maloney, 1994). Therefore, a research is needed to identify the students' problem-solving skill and concept mastery on the topic of temperature and heat.

The concept mastery cannot be reached only by using traditional learning (Bass et al., 2009), thus, certain learning model supporting the student's concept mastery on the topic of temperature and heat is urgently required. In this work, one of the solutions proposed by the researcher to improve the students' problem-solving skill and concept mastery is applying the HPIL (Hints and Peer Interaction Learning) model in the learning process. The HPIL is expected to improve the problem-solving skills and concept mastery of heat since the HPIL covers a more effective learning giving hints to the students before doing an evaluation as the student activation and doing peer interaction as the student discussion with their mates to compare the students' understanding through a discussion. HPIL model is a new model developed by Leinonen et al. (2013b). In that research, HPIL was applied since the model could significantly enhance the concept mastery and qualitative problem-solving (Cheng & Ku, 2009). Thereby, this research aimed to uncover the improvement of problem-solving skills and physics concept mastery on temperature and heat topics by applying a learning model of HPIL.

METHODS

This research used a mixed method combining the quantitative and qualitative. The research design used in this research was embedded experimental model (Cresswell & Clark, 2013). The population used in this research was one of the Senior High Schools in Malang City while the sample was 22 students. The sample selection was performed by simple random sampling technique; lottery. The topic taught was temperature and heat. The instruments were in the form of test items consisting of 25 numbers including five numbers of es-

say item for the problem-solving skills and 20 numbers of reasoning multiple choices items for the concept mastery. This research was conducted to measure the problem-solving skills. The problem-solving skills consist of four indicators; identifying the problem, planning the problem-solving, applying the problem-solving, and checking the adapted answer (Cukurova et al., 2016). The data of problem-solving skill were measured by using an essay test based on a rubric of the heat and its move. The data analysis comprised quantitative and qualitative analysis. The quantitative analysis included the normality test, hypothesis test, N-gain, D-Effect Size. The normality test used Kolmogorov Smirnov while the hypothesis test employed the paired sample-test. The qualitative data analysis obtained from the data processing of the students' concept mastery by analyzing the reason written by the students when they finished the pre-test and post-test.

RESULTS AND DISCUSSION

The purpose of this study was to improve the problem-solving skills and physics concept mastery by implementing the HPIL model. The steps of the learning included pre-introduction, introduction, key activity, and closing activity. The core activity consisted of individual working, hints and peer interaction. The description of problem-solving skills data and the description of problem-solving skills data are presented in Table 1.

Table 1. The Description of Problem-Solving Skills

Statistical Description	Pre-Test	Post-Test
The number of students	22	22
Mean	40.68	74.77
Maximum score	50	95
Minimum score	30	60

Based on Table 1, the statistical description of the students' pre-test mean on problem-solving skills in the experiment class was 40.68 with the total number of the student was 22 and the students' post-test mean on problem-solving skills in the experiment class was 74.77 with the total number of the student was 22. Based on the description of problem-solving skills data, the comparison of the mean of problem-solving skills in the pre-test and post-test is shown in the following Figure 2.

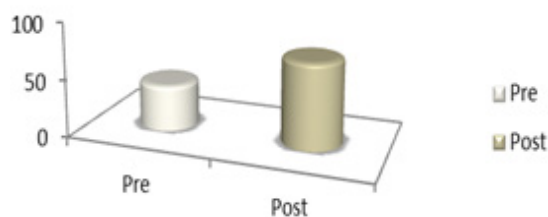


Figure 2. The Comparison of Problem-Solving Skills Average

Based on Figure 2, there was a difference of the students' mean of problem-solving skills in the pre-test and post-test using the HPIL model. From the figure, we could conclude that the mean score of problem-solving skills using the HPIL model was higher than before using the HPIL model. The data of physics concept mastery are presented in Table 2.

Table 2. The Description of Concept Mastery Data

Understanding Degree	Average (%)	
	Pre-Test	Post-Test
Understanding the concept	0.48	0.72
Misconception	0.18	0.08
Not understand	0.33	0.2

Based on Table 2, the average score of students mastering the concept increased from 0.48 to 0.72, the average of students' misconception decreased from 0.18 to 0.08, while the average of students who did not understand the concept decreased from 0.33 to 0.2 after treatment.

Going on the description of concept mastery data, the comparison of the average of concept mastery in pre-test and post-test is shown in Figure 3.

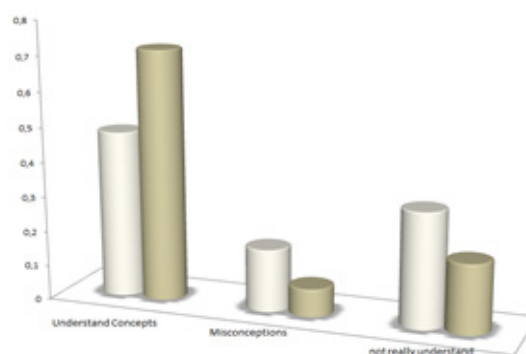


Figure 3. The Comparison of Concept Mastery Average

Based on Figure 3, there was a difference of the average of understanding the concept, misconception, and do not understand the concept at the pre-test (before using HPIL) and post-test (after using HPIL). From the figure above, we could draw a conclusion that the mean score of concept mastery using the HPIL model was higher than before using the HPIL model. Before doing the hypothesis test, the analysis of pre-requirement test was done first in the form of a hypothesis test. The normality test results of problem-solving skills and concept mastery were distributed normally. The results of the hypothesis test of this research are presented in Table 3.

Table 3. The Result of Hypothesis Test of Problem-Solving Skill

Pair Pre and Post	
Sig _{counting}	0.00
Sig _{table}	0.05

Based on the analysis results, the problem-solving skills showed $\text{Sig}_{\text{counting}} < \text{Sig}_{\text{table}}$ ($0.00 < 0.05$), therefore, we could conclude that H_0 was rejected and H_1 was accepted. This showed that the problem-solving skills increased by using the HPIL model.

Meanwhile, the analysis of N-gain score used to know the increase in pre-test and post-test was in the low category with the score of 0.34. To know the strength difference, the pre-test and post-test were in the moderate effect category with the score of 0.70. Subsequently, the hypothesis test data of concept mastery are presented in Table 4.

Table 4. The Results of Hypothesis Test of Concept Mastery

Pair Pre and Post	
Sig _{counting}	0.00
Sig _{table}	0.05

Based on the analysis result, the concept mastery showed $\text{Sig}_{\text{counting}} < \text{Sig}_{\text{table}}$ ($0.00 < 0.05$), thus, we could conclude that the H_0 was rejected and H_1 was accepted. This case showed that the concept mastery increased by using the HPIL model. Meanwhile, the analysis of N-gain value used to know the increase in pre-test and post-test was in the low category with the score of 0.23. To know the strength difference, the pre-test and post-test were in the

moderate effect category with the score of 0.26.

The results showed an enhancement of the problem-solving skills after using the HPIL model proven by the increase of pre-test and post-test mean from 40.68 to 74.77. The increase in the problem-solving skills in this research was categorized as low since the score of N-gain was 0.34. The problem-solving skills of pre-test and post-test were based on the N-gain score, which was normalized at the moderate category having the score of 0.34. The previous research also proved that the improvement of the students' problem-solving skills was in a low category because the students found it difficult in solving the physics problems (Pol et al., 2008).

The research results by Tambychik & Meerah (2010) pointed out that 80% of the participants had troubles in solving mathematical problems compared to verbal problems. This was because most participants feel bored in completing tasks, in addition to requiring a lot of knowledge, work procedures, and require additional time in thinking. Furthermore, Snetinova & Koupilova (2012) revealed that many students had low problem-solving skills, which resulted in difficulties in solving physical problems. These occurred due to the lack of essential knowledge in solving physical problems, including declarative knowledge (facts & concepts), procedural knowledge (how to use facts and concepts in methods/procedures), and strategic knowledge (needed to regulate the process of new problem solving).

The description of the students' problem-solving skills improvement from the pretest to posttest is described through the students' answer transcribed as follows. The example of question number 1.

Andi experimented by heating water (A) and cooking oil (B), where mass A and B were the same. A few minutes later, it turned out that the temperature of cooking oil increased faster than water.

- Why does the temperature of cooking oil increase faster?
- Write the relationship between the specific heat and the increase in temperature.

Student Answers (Pre-Test)

- The temperature of the oil is faster heat because the specific heat is greater than water so the heat needed is also large.
- Specific heat has a relationship; if the temperature is slow then the specific heat gets smaller.

Student Answers (Post-Test)

a. Oil heat faster than water because oil has a smaller specific heat. The smaller the specific heat, the faster the heat as it requires less heat, while the greater the specific heat, the slower the heat since the heat needed must also be more.

b. The greater the specific heat, the slower the increasing temperature, on the contrary, the smaller the specific heat, the faster the increasing temperature. Thus, the relationship between increasing type of heat and temperature is inversely proportional ($c \sim 1/\Delta T$).

The students' answers during the pretest were categorized at the level 2 since they could only determine problems known and asked but were not in accordance with the concept, however, they could rewrite the problem in a different form. After experiencing learning with the HPIL model, the students' answers changed drastically or experienced a significant increase to the level 4. At this level, they could determine problems known and asked based on the concepts and rewrite problems in different forms (mathematical, graphs and diagrams)

Meanwhile, the calculation of the different strength between the pre-test and post-test employed the D-Effect Size. On the basis of this research, we could see that the strength difference between the pre-test and post-test was in the category of 'strong enough' effect, having the score of 0.70. This was due to the significant difference in the students' scores during the pre-test and post-test. Another factor causing the problem was the limited time in doing pre-test and post-test. From the five questions given, the students were more skillful in doing the calculation item than the concept item. The analysis results stated that the HPIL learning model could improve the students' problem-solving skills proven by the analysis of $\text{sigcounting} < \text{sigtable}$ ($0.00 < 0.05$). The results of this research were similar to the previous research reporting that the HPIL model could improve the qualitative problem-solving skill and concept mastery significantly (Leinonen et al., 2013b).

The improvement of HPIL model is a new development of learning developed by Risto Leinonen (2013a). In his research entitled 'overcoming students misconceptions concerning thermal physics with the aid of hints and peer interaction learning during lecture course', there are some phases of HPIL. The first phase was individual working. In this step, the students did the diagnostic test individually. This phase was used to encourage the students to implement the topic that has been taught and the homework ses-

sion. After that, a hints phase was planned to state whether the hints related to the physical topic can improve the students' concept mastery. In the hints phase, the teacher gave a guide in the form of concept and formulation. The last was Peer Interaction phase; the students were asked to compare their answers to their partner and discuss. From such activities, there will be an interaction between the peers in sharing the idea based on the answer of everybody so that there will be an interaction to build a new knowledge and students' problem-solving process (Tolmie et al., 2010). Therefore, basically, in the learning process, the students in the group are expected to be heterogeneous meaning that the students having much more knowledge can share their knowledge with the ones having a little knowledge.

The results of concept mastery data were obtained from the reasoning multiple choices items. The data analysis result showed that the students' concept mastery increased after they were given treatment. From the multiple choices test given in pre-test and post-test, the students who understood the concept increased from 0.48 to 0.72, the students who underwent misconception decreased from 0.18 to 0.08, and the students who did not understand the concept decreased from 0.33 to 0.2. These cases showed that the level of concept mastery increased after giving the treatment. The HPIL model also can improve the student's concept of mastery. This case is proven by the analysis of $\text{sigcounting} < \text{sigtable}$ ($0.00 < 0.05$). The results of this research were similar to the previous research stating that HPIL can improve the qualitative problem-solving skill and the concept mastery significantly (Leinonen et al., 2013b). The increase in the problem mastery in pre-test and post-test based on the normalized N-gain score was at a low category. The improvement of the problem mastery in pre-test and post-test based on the normalized N-gain score was at the low category with the range of 0.23; this research result was similar to the previous research reporting that the improvement of students' problem-solving skill was at a low category (Pol et al., 2008). Meanwhile, to measure the difference strength between pre-test and post-test was by using D-Effect Size calculation. From this research, we found that the difference strength in pre-test and post-test was categorized as the moderate effect with the range of 0.26. This case was because the difference between pre-test and post-test scores increased insignificantly. Another factor was time management in doing pre-test and post-test. The goal of the students' concept mastery improvement was to make the students have

better knowledge when they are in the higher level of the carrier and increase the students' critical thinking skill and creative thinking (Saprudin et al., 2017).

CONCLUSION

Based on the discussion explained before, we can draw a conclusion that there was an increase in students' problem-solving and concept mastery in class X of Senior High School in Malang on the topic of temperature and heat after the students were taught by using HPIL model. The hypothesis test results on both variables also indicated that $\text{sig}_{\text{counting}} < \text{sig}_{\text{table}}$ ($0.00 < 0.05$). It means that there was a significant difference between the pretest and posttest through the application of the HPIL model to problem solving skills and physics concept mastery. Thereby, the HPIL can be recommended to improve the students' problem-solving skills and physics concept mastery. The further research is expected to see the other aspects such as the students' conceptual change (mental model), creativity and critical thinking related to physics learning by using the HPIL model.

ACKNOWLEDGEMENTS

The author team wishes to thank Dr. War-tono, M.Pd, who is currently active as a teaching staff in the physics education study program, State University of Malang on scientific contribution in the field of physics education to assist the team in providing valuable input so that this research and writing will be better presented before scholars in the whole world.

REFERENCES

- Anderson, L. W., & Krathwohl, D. R. (2016). *A Taxonomy for Learning, Teaching and Assessing: a Revision of Bloom's Taxonomy*. New York: Longman Publishing.
- Argaw, A. S., Haile, B., Ayalew, A. T., & Kuma, S. G. (2017). The Effect of Problem Based Learning (pbl) Instruction on Students' Motivation and Problem Solving Skills of Physics. *EURASIA Journal of Mathematics Science and Technology Education*, 13(3), 857-871.
- Bass, J. E., Contant, T. L., & Carin, A. A. (2009). *Teaching Science as Inquiry*. Allyn & Bacon/Pearson.
- Cheng, Y. C., & Ku, H. Y. (2009). An Investigation of the Effects of Reciprocal Peer Tutoring. *Computers in Human Behavior*, 25(1), 40-49.
- Cresswell, J. W., & Clark, P. (2013). *Designing and Conducting Mixed Method Research*. California: Sage Publication, Inc.
- Cukurova, M., Avramides, K., Spikol, D., Luckin, R., & Mavrikis, M. (2016, April). An Analysis Framework for Collaborative Problem Solving in Practice-Based Learning Activities: A Mixed-Method Approach. In *Proceedings of the Sixth International Conference on Learning Analytics & Knowledge* (pp. 84-88). ACM.
- Gaigher, E., Rogan, J. M., & Braun M. W. H. (2007). Exploring the Development of Conceptual Understanding through Structured Problem-Solving in Physics. *International Journal of Science Education*, 29(9), 1089-1110.
- Gok, T., & Silay, I. (2010). The Effect of Problem Solving Strategies on Student's Achievement, Attitude and Motivation. *Latin-America Journal of Physics Education Research*, 4(1), 7-21.
- Greiff, S., S. Wustenberg, B. Csapo, A. Demetriou, J. Hautamaki, A. C. Graesser., & Martin, R. (2014). Domain-General Problem Solving Skills and Education in the 21st Century. *Educational Research Review*, 13, 74-83.
- Hafizah, E. (2014). Pengaruh Anchored Instruction terhadap Penguasaan Konsep dan Kemampuan Pemecahan Masalah Fisika Siswa Kelas X. *Disertasi dan Tesis Program Pascasarjana UM*.
- Hegde, B., & Meera, B.N. (2012). How Do They Solve it? An Insight into the Learner's Approach to the Mechanism of Physics Problem Solving. *Physical Review Special Topics-Physics Education Research*, 8(1), 1-9.
- Leinonen, R. (2013a). Improving the Learning of Thermal Physics at University. *Publications of the University of Eastern Finland. Dissertations in Forestry and Natural Sciences*, (124).
- Leinonen, R., Asikainen, M. A., & Hirvonen, P. E. (2013b). Overcoming Students' Misconceptions Concerning Thermal Physics with the Aid of Hints and Peer Interaction During a Lecture Course. *Physical Review Special Topics-Physics Education Research*, 9(2), 1-22.
- Lin, S. Y., & Singh, C. (2010, October). Using Analogy to Solve a Three-Step Physics Problem. In *AIP Conference Proceedings* (Vol. 1289, No. 1, pp. 29-32). AIP.
- Maloney, D. P. (1994). *Research on Problem Solving: Physics*. New York: Macmillan.
- Meyer, J., & Land, R. (2006). *Overcoming Barriers to Student Understanding: Threshold Concepts and Troublesome Knowledge*. Routledge.
- Minner, D. D., Levy, A. J., & Century, J. (2010). Inquiry-Based Science Instruction—What is it and Does it Matter? Results from a Research Synthesis Years 1984 to 2002. *Journal of Research in Science Teaching: The Official Journal of the National Association for Research in Science Teaching*, 47(4), 474-496.
- Pol, J., Harskamp, E. G., Suhre, C. J. M., & Goedhart, M. J. (2008). The Effect of Hints and Model Answers in a Student-Controlled Problem-Solving Program for Secondary Physics Education. *Journal Science Education Technology*, 17(4), 410-425.

- Rohanum, E. (2013). *Pengaruh Authentic-Problem Based Learning Terhadap Kemampuan Pemecahan Masalah Fisika Ditinjau Dari Kemampuan Awal Peserta Didik MAN 1 Malang* (Doctoral dissertation, Tesis tidak diterbitkan. Malang: PPs UM).
- Saprudin, S., Liliyasi, L., & Prihatmanto, A. S. (2017, September). Pre-Service Physics Teachers' Concept Mastery and the Challenges of Game Development on Physics Learning. In *Journal of Physics: Conference Series* (Vol. 895, No. 1, p. 012109). IOP Publishing.
- Snetinova, M., & Koupilova, Z. (2012). Students' Difficulties in Solving Physics Problems. *WDS'12 Proceedings of Contributed Papers*, 93-97.
- Stice, J. E. (2007). Teaching problem solving. *Teachers and Students Sourcebook: Alternative Teaching Methods*.
- Tambychik, T., & Meerah, T. S. M. (2010). Students' Difficulties in Mathematics Problem-Solving: What do they Say?. *Procedia Social and Behavioral Sciences*, 8, 142-151.
- Tolmie, A. K., Topping, K. J., Christie, D., Donaldson, C., Howe, C., Jessiman, E., ... & Thurston, A. (2010). Social effects of collaborative learning in primary schools. *Learning and instruction*, 20(3), 177-191.
- Viennot, L., & Décamp, N. (2015). Codevelopment of conceptual understanding and critical attitude: toward a systemic analysis of the survival blanket. *European Journal of Physics*, 37(1), 1-25.
- Wambugu, P. W., & Changeiywo, J. M. (2008). Effects of Mastery Learning Approach on Secondary School Students' Physics Achievement. *Eurasia Journal of Mathematics, Science & technology education*, 4(3), 293-302.
- Young, H.P. & Freedman, R. A. (2004). *University Physics With Modern Physics 11th Edition*. San Francisco: Pearson.
- Zacharia, Z. C., Olympiou, G., & Papaevripidou, M. (2008). Effects of Experimenting with Physical and Virtual Manipulatives on Students' Conceptual Understanding in Heat and Temperature. *Journal of Research in Science Teaching: The Official Journal of the National Association for Research in Science Teaching*, 45(9), 1021-1035.

**REVISITING GENERIC SCIENCE SKILLS AS 21ST CENTURY SKILLS ON BIOLOGY LEARNING****M. Haviz^{*1}, H. Karomah², R. Delfita³, M. I. A. Umar^{4,5}, I. M. Maris⁶**^{1, 2, 3, 4, 6}Faculty Tarbiyah and Science Education, Institut Agama Islam Negeri (IAIN) Batusangkar, Indonesia⁵Faculty of Science and Technology, Universiti Kebangsaan Malaysia, Bangi, Malaysia

DOI: 10.15294/jpii.v7i3.12438

Accepted: February 24th, 2018. Approved: August 31st, 2018. Published: September 20th, 2018**ABSTRACT**

The purpose of this study was to describe the generic skills of students' science who conducted experiments on biology learning grade VIII Junior High School (SMP) in Batusangkar. This study used a descriptive quantitative design. The variables of this research were generic science skills as the 21st-century skills and students achievement. A total of 295 students were used as the populations and the purposive sampling technique was employed to select one class as the research sample (n=32 students). The student activities, such as a direct observation, awareness of scale, logical framework, cause-effect, modeling, and the inference was observed by 6 observers. This activity was designed and adapted based on the generic science skills and 21st-century skills. The percentage of students' achievement and generic science skills score was analyzed with descriptive statistics. The students' achievement showed that all students were successful, with a mean score > 75. The students' generic science skills mean scores was categorized as: very good, good and sufficient, and all students were completed the learning. The highest (very good) performance was on the modeling activities with the average percentage of 87.49%. The results indicated that the skills were considered to be part of generic science skills and 21st-century skills. The results of this study concluded and suggested the need to revisit and reaffirm the inclusion of generic science skills in biology learning because this skill becomes part of or similar to the 21st-century skills.

© 2018 Science Education Study Program FMIPA UNNES Semarang

Keywords: generic science skill, 21st-century skill, biology learning

INTRODUCTION

At years 2010-2018, research on 21st skills was reported by many researchers, such as an investigation of 21st century learners' competencies in China (Cai et al., 2017), teachers' actual and preferred perceptions of twenty-first century learning competencies (Sang et al., 2018), and comparative study about inventive thinking skills in science between students in Malaysia and Brunei (Muhammad & Osman, 2010). Jia et al. (2016) and Ercikan & Oliveri (2016) conducted the development and validation of the instrument

of 21st-century student skill. Boyer & Crippen (2014); Bell (2010); and Duran et al. (2011) conducted the study of the use of certain methods in learning to bring up 21st-century students' skills in science classes. In other explanations, the studies listed above show that 21st century skills are a "hot" topic in education of science (Geisinger, 2016) besides the research about nanotechnology and graphene in pure science (Umar et al., 2013; Umar et al., 2017; Umar et al., 2018). Because 21st-century skills required by students to perform their activities in the future (Larson & Miller, 2011), or 21st-century skills are beneficial to their lives after graduation (Kaufman, 2013).

***Correspondence Address**

E-mail: mhaviz@iainbatusangkar.ac.id

Moreover, the studies about the 21st-century skills in learning have also reported by many researchers. For example, the study of assessing and teaching 21st-century skills in science has been investigated by Griffin (2017), and the use of evaluation in 21st-century learning has reported by DiCerbo (2014). Furthermore, the study of 21st-century skills in information technology is reported by Lambert & Gong (2010); and Fry & Seely (2011). Sibille et al. (2010) conducted research about preparing physicians for the 21st century, and Jang (2016) have identifying 21st century STEM competencies using workplace data. These of the study indicate that 21st century skills are important skills to be given to students in learning and its have to include at curriculum.

However, before the 21st-century skill becomes a research trend, research on generic skills and/or science process skills is also a “hot” topic in education studies, especially in the field of science learning. Ambross et al. (2014) investigated the implementation and development of science process skills in the natural sciences. Koksall & Berberoglu (2014) pointed out the effect of guided-inquiry instruction on 6th-grade Turkish students’ achievement, science process skills and attitudes toward science. Durmaz & Mutlu (2017) studied the effect of an instructional intervention on elementary students’ science process skills. Coil et al. (2010) investigated effective methodology in teaching the process of science. Stone (2014) elucidated faculty perceptions and an effective methodology in teaching the process of science. Walters & Soyibo (2010) conducted a study of high school students’ performance by applying the integration of five science process skills. Colley (2010) conducted a study about understanding ecology content knowledge and acquiring science process skills through project-based science instruction. Savitri et al. (2017) have enhanced science students’ process skills through an implementation of green learning

method (GeLeM) with conservation-based inquiry approach.

There are also researchers who conducted the study of generic skills. Jääskelä et al. (2016) examined the models for the development of generic skills in Finnish higher education. Mulyani et al. (2016) have investigated students’ generic skill in science through chemistry learning using ICT-based media on reaction rate and osmotic pressure material. Badcock et al. (2010) developed the generic skills through university study. Rhee & Kim (2012) conducted differential pathways to generic skills development of male and female college students in Korea. Natoli et al. (2014) investigated the impact of instructor’s group management strategies on students’ attitudes to group work and generic skill development. Joseph et al. (2015) examined the relationship between student development activities and core generic competencies among tertiary science and technology students. Cecilia et al. (2017) carried out a review of the literature on challenges in the development and implementation of generic competencies in the higher education curriculum. The results informed that there are some generic skills that have been applied in universities such as leadership and communication, collaboration and teamwork, globalization and cultural awareness and entrepreneurship which are important to be achieved by students.

The above explanations make clear that generic science skills are similar to or part of 21st-century skills. These explanations also show that a study of revisiting generic science skills as 21st-century skills is important to conduct in learning. In this study, the researchers described the generic science skills in biology learning. Prior to the research, the researchers made a comparison of the generic skills written by George (2011) and 21st-century skills proposed by Greenstein (2012). The comparison results are summarized in Table 1.

Table 1. The Comparison of Generic Skills and 21st Century Skills

Generic Skills (George, 2011)		21st Century Skill (Greenstein, 2012)	
Main Skills	Focus Skill	Main Skills	Focus Skill
Thinking	Reasoning, critical thinking, creative thinking	Thinking	Creativity, critical thinking, problem-solving and metacognition
Computation	Following instructions, arithmetic, spatial ability	Acting	Communicating, debate, collaborating, digital literacy and technology literacy
Communication	Speech, reading, writing, listening, expression	Life	Civics and citizenship, global, leadership and responsibility, work ethic, college/career/workplace, flexibility/adaptability and initiative/motivation

problem solving	analyzing, decision making, applying, verifying
independent learning	study habits, planning, research, evaluation
information processing	technology, multimedia awareness, using the library
team management	discussing, cohesion, commitment, cooperation
self-management	knowing self, managing time, using resources

Table 1 explains that the main skill of thinking is found both in generic skills and 21st-century skills. Other skills found in both groups are critical thinking, creative thinking, problem-solving, communication, technology, and cooperative (collaboration). While the living skill focusing on the civics and citizenship skills, global, leadership and responsibility, work ethic, college or career or workplace, flexibility/ adaptability, and initiative or motivation are only found in 21st-century skills. This explanations also indicate that generic science skills are similar to or part of 21st-century skills. These explanations also show that a study of revisiting generic science skills as 21st-century skills is important to conduct in learning.

Teaching and learning science in Junior High School in Indonesia should provide students with experiments containing both skill groups; the generic skill and 21st-century skills. To examine this matter, the researchers conducted a research on the application of generic science skills to science learning in junior high school. The aroused research problem was; how do the junior high school students conduct science experiments covering the generic science skill and/or the 21st-century skills in learning biology? The purpose of this study was to describe the generic skills of students' science who conducted experiments on biology learning in grade VIII of junior high school (SMP). The experimental topic was about the motion of living things. The students' generic science skills were observed during the experiments of the stimulation effect on the motion of *Mimosa pudica* and analyzing the motion of animals based on the body structure and its mass. This study employed the scientific learning

approach. In terms of skills, the scientific learning has stages observing, asking, trying, reasoning, testing and creating (Regulation of the Minister of Education and Culture of the Republic of Indonesia Number 22 of 2016).

METHODS

This study was descriptive quantitative (Creswell, 2014). The variables in this study were the generic science skills and student achievement. The students' generic science skills were observed and recorded by observers using observation sheets. These skills were in the form of direct observation, scale awareness, cause and effect, modeling, logical framework, and inference. The population in this study were 295 students in grade VIII Junior High School (SMPN) 1 Batusangkar, West Sumatra. We used purposive sampling technique by taking one class with the number of 32 students.

The instruments used were the observation sheets and experimental guides. The observation sheets were to observe the students' generic science skills. The students' experimental guideline comprised experimental procedures and worksheet. The instruments were adopted from Rahman (2008) and Brotoiswoyo (2001). The activities consisted of direct observation, scale awareness, logical framework, causal-effect, modeling, and inference. After the adaptation and theoretical analysis, it found that the six activities were classified into thinking and skill problems based on the grouping of the 21st-century skill (Greenstein, 2012) and generic skills (George, 2011). Comparisons of 21st-century skills, generic skills, and skills based on observed student activity are summarized in Table 2.

Table 2. The Comparison of 21st-Century Skills, Generic Skills and Student Activities Observed during the Experiment of Motion in Living Things

21st Century Skill (Greenstein, 2012)		Generic Skills (George, 2011)		Student Skill Observed (Rahman, 2008; Brotosiswoyo, 2001)	
Main Skills	Focus Skill	Main Skills	Focus Skill	Skill	Students Activity
Thinking	Creativity, critical thinking, problem-solving and metacognition	Thinking Skills	Reasoning, critical thinking, creative thinking	Direct observation	Observing and revealing the characteristics of the object with the senses by using the tool or not using the tool
				Awareness of scale	Using size, quantity, and unit and compare objects to one another
				Logical framework	Grouping by criteria
		Problem Solving Skills	Analyzing, decision making, applying, verifying	Cause-effect	Explaining, linking or determining treatment and treatment results
				Modeling	Performing a particular demonstration or activity to be emulated and describing the data obtained or vice versa
		Inference	Drawing up conclusions based on observations		

Prior to use, the observation sheet was tested for its content and construction. The instruments were declared valid after being assessed by 4 validators. Then, the researchers revised the instruments based on the validators' suggestion. The validation test results informed that the instruments were valid with a mean score of 3.35 (at 1-4 assessment scale) (Creswell, 2014). There were several suggestions from the validator team to revise the instrument, research guidelines and language. All of the suggestions have been accepted for the improvement of the research instruments. Then, to test the internal consistency, the instrument reliability test was performed. The instruments were tested on the students who were not the research sample. The instrument reliability test results showed that the instrument owned sufficient reliability value with the Alpha value of $0.595 > 0.355$. Therefore, it concluded that the instruments were valid and reliable.

To collect the data, the students were divided into 6 groups of practical work. Prior to the implementation of the experiment, each student was coded with numbers to facilitate the observers in assessing each student's activity. The experimental sub-topic of motion in living things

done by students was the stimulation effect on the motion of *Mimosa pudica*, and animal motion based on its structure body and mass. During the experiment, the students filled out the activity sheets. The generic science skills generated by the students were observed and reported by the observers on the observation sheets. Each group was observed by one observer (n observer = 6 people). The observers were a team of researchers and already have a common understanding of the generic skills and science observation procedure. At the end of the learning process, we conducted a post-test to determine the students' achievement and its completeness. To analyze the data, the percentage of the generic science skill scores were assessed based on the following criteria: 86-100 (very good); 76-85 (good); sufficient (60-75); less (55-59); very less (55-59) and less once (≤ 54). The scores of students' achievement were analyzed with descriptive statistics.

RESULTS AND DISCUSSION

In this study, the student answered the questions and wrote it on the worksheets. For instance, during the observation of the stimula-

tion effect on closing/opening the leaves of *Mimosa pudica*, the students performed experimental activities based on the following questions and student answers.

Question 1: What are you trying to do?

Student answers: closing and opening the leaves of *Mimosa pudica*.

Question 2: What do you think?

Student answers: (a) *Mimosa pudica* leaves close when you touch it.

(b) *Mimosa pudica* leaves close when given cold excitatory

(c) *Mimosa pudica* leaves close when given hot stimuli

Question 3: What do you provide?

Student answers:

(a) *Mimosa pudica* plant (live)

(b) Ice wrapped in plastic

(c) lighted lighters or candles

(d) stopwatch or timers

Question 4: What are you doing?

Student answers:

(a) Treating the *Mimosa pudica*; (1) touching it using the fingertips at the top of the leaf surface; (2) touching it using the fingertips on the petiole; (3) giving cold temperatures by laying ice cubes beneath the leaf surface; (4) giving the heat temperature by placing a flame or a burning candle

(b) Observing the *Mimosa pudica* leave and stem

(c) Recording the speed of plant response to excitatory using stopwatch

(d) Repeating steps 1-3 in part a (3 times)

(e) Recording the observed data

Table 3. The Example of Students' Record during the Observation

Treatment	Time (minute)		
	1 st round	2 nd round	3 rd round
	Close at	Close at	Close at
Touching the leaf surface	01.43	01.52	01.55
Touching the petiole	03.03	03.01	03.04
Giving cold temperature on beneath the leaf surface	03.14	03.10	03.15
Giving hot temperature on beneath the leaf surface	06.56	07.02	07.06

Question 5: What are your conclusions?

(a) How does *Mimosa pudica* respond when given a touch stimulus on the leaf surface?

Student answer: The leaves of *Mimosa pudica* closes and opens in a very short time.

(b) How does *Mimosa pudica* respond when given a touch stimulus on the petiole?

Student answer: The leaves of *Mimosa pudica* closes and opens in a short time

(c) How does *Mimosa pudica* respond when given cold stimuli?

Student answer: The leaves of *Mimosa pudica* closes and opens in a longer time

(d) How does *Mimosa pudica* respond when given hot stimuli?

Student answer: The leaves of *Mimosa pudica* closes and opens in a very long time

(e) Which part is the most sensitive to the touch stimulator?

Student answers: the most sensitive part of the touch plan is the leaf surface

(f) Is the response speed different from each stimulus?

Student answers: yes, this type of stimulus has a different response speed.

(g) What can you conclude based on the above activities?

Student answers: The most sensitive part to excitatory are the leaves while the slightly sensitive part is the petiole. The most immediate stimuli affecting the motion of closing and opening is a touch.

The observers have made observations based on the question and student answers. the question and student answers have illustrated that the students owned the generic science skills. The students' answer to the Question 1 and 2 indicated that they have acquired the cause-effect skills and their answers at the 4a and 4b described their direct observation skills. Furthermore, the students' answer at the 4e showed their awareness of the scale. In addition, the students' answer at the 5(a), 5(b), 5(c) and 5(d) pointed out their modeling skills, while the answer of 5(e) and 5(f) indicated logical framework skills. Finally, the answer of 5(g) elucidated the students' inference skills

The observation results on the students' generic science skills informed that the highest mean score was found in the modeling skills, 87.49% (very good). The lowest means score were found at the direct observation skills 74.3% (sufficient) and awareness 71.17% (sufficient). The data of the students' generic science skills scores in experimental motion on living things are summarized in Table 3. The post-test scores of the students' achievement on the living organism motion showed that all students (n=32 students) succeeded in having the mean score > 75. This results indicated that all students completed the mastery learning.

Table 4. The Scores of Generic Science Skills on the Experiment of Living Things Motion

Experimental Group	Percentage Scores of Generic Science Skills of the Students					
	Direct Observation	Awareness of Scale	Logical Framework	Cause-Effect	Modeling	Inference
1	89.58 %	62.50 %	95.83 %	97.91 %	95.83 %	75.00 %
2	70.83 %	41.67 %	79.16 %	72.91 %	83.30 %	70.83 %
3	64.58 %	72.91 %	70.83 %	83.30 %	79.16 %	79.16 %
4	67.70 %	83.33 %	75.00 %	70.83 %	83.33 %	79.16 %
5	66.14 %	66.66 %	70.83 %	68.75 %	83.33 %	75.00 %
6	86.97 %	100.00 %	83.30 %	81.25 %	100.00 %	95.83 %
Σ	445.80 %	427.07 %	474.95 %	474.95 %	524.95 %	474.98 %
Mean	74.30 %	71.17 %	79.15 %	79.15 %	87.49 %	79.16 %
Category	sufficient	sufficient	good	good	very good	good

The students carrying out the experiment systematically indicated that they have acquired the direct observation skills while those recording time needed during the experiment showed that they got the scale awareness. Moreover, the students distinguishing the stimulus types elucidated their logical framework skills. Additionally, the ability to explain the cause of the closing/opening of the *Mimosa pudica* leaves showed the students' cause and effect skills, and their activity of recording the data indicated the modeling skills. Therefore, it was said that the students have got the generic science skills.

The students performed very well during the modeling activities. The modeling activities in the experiment were to hold a particular demonstration or activity to describe the obtained data. These findings made clear that the students have got the generic skills. When referring to the generic explanation of science skills written by George (2011), the students already had the main skills of problem-solving, focusing, analyzing, decision-making, applying and verifying. These findings also elucidated that the students acquired the 21st-century skills of thinking, focusing, and problem-solving skills. This is in line with the explanation of Greenstein's (2012), that as the part of 21st-century skills, thinking skills were divided into critical, problem-solving, creativity and metacognition.

The above explanation informed that science learning in Indonesia at the junior high school level has actually provided the students with 21st-century skills. The research findings have proven that learning objectives covering the aspect of attitudes, knowledge, and skills have been accomplished through a variety of skills in the core activities. In accordance with the established standard, the learning should cover the

observing, asking, trying, reasoning, testing and creating activities (Regulation of the Minister of Education and Culture of the Republic of Indonesia Number 22 of 2016). This research was a true implementation of Indonesia's 2013 Curriculum covering the aspect of attitude, knowledge, and skills realized through the series of activities containing the scientific approach principles, discovery/inquiry, and project-based learning. The activities also demonstrated the generic science skills which belonged to the science process skills.

Some 21st century skills in Gray & Koncz's (2014) article are the leadership, teamwork, written communication skills, problem-solving skills, work ethic, analytical/quantitative skills, technical skills, communication skills (verbal), initiative, computer skills, flexibility/adaptability, interpersonal skills, detail oriented, organizational ability, strategic planning skills, friendly/outgoing personality, entrepreneurial skills/risk-taker, tactfulness dan creativity (Gray & Koncz, 2014). Furthermore, Greenstein (2012) explained that the 21st-century skills of thinking include creativity, critical thinking, problem-solving and metacognition, communication, collaboration, information, and technology literacies are the tools for working. On the other hand, the citizenship, life skills, and personal responsibility are necessary for everyday life. Referring to Ahonen & Kinnunen (2015), some 21st-century skills needed by students in learning are problem-solving, reasoning, collaboration, self-regulation (Ahonen & Kinnunen, 2015). Therefore, the researchers agreed that the findings of this study indicated the similarity between generic science skills and the 21st-century skills. These skills must be possessed by the students after learning in the science classroom, also, could be generated by the students with the help of teachers. Thus, teachers

should make use of certain learning methods to help students acquire those skills. Some aids or methods that a teacher could adopt in their science class are the computer-based game (Annetta et al, 2009), critical thinking skills on biology (Tiruneh et al., 2016), visual knowledge skills in biology (Kinchin, 2011), cooperative skills on biology (Haviz, 2015), integrated learning skills on biology (Haviz, 2016). A good teacher should know what the students need, therefore, s/he has to conduct an educational mini research in her/his class (Schenzel, 2013) and optimize teacher-student dialogue (Kinchin, 2010).

CONCLUSION

The students have done several steps during the experiment on living thing motion which comprised the generic science skills in the form of direct observation, scale awareness, logical framework, cause and effect, modeling, and inference. The highest score was on the modeling having an average percentage of 87.49%. The post-test scores showed that all students have passed the mastery learning having the mean score > 75, indicating that they have acquired the generic science skills which are part of the 21st-century skills. Therefore, the researchers suggested that the educators revisit and reaffirm the generic science skills in science learning, especially in biology learning.

REFERENCES

- Ahonen, A. K., & Kinnunen, P. (2015). How do Students Value the Importance of Twenty-First Century Skills? *Scandinavian Journal of Educational Research*, 59(4), 395-412.
- Ambross, J., Meiring, L., & Blignaut, S. (2014). The Implementation and Development of Science Process Skills in the Natural Sciences: A Case Study of Teachers' Perceptions. *Africa Education Review*, 11(3), 459-474.
- Annetta, L. A., Minogue, J., Holmes, S. Y., & Cheng, M. T. (2009). Investigating the impact of video games on high school students' engagement and learning about genetics. *Computers & Education*, 53(1), 74-85.
- Badcock, P. B. T., Pattison, P. E. & Harris, K. L. (2010). Developing Generic Skills through University Study: A Study of Arts, Science and Engineering in Australia. *Higher Education* 60, (4), 441-458.
- Bell, S. (2010). Project-based Learning for the 21st Century: Skills for the Future. *The Clearing House: A Journal of Educational Strategies, Issues and Ideas*, 83(2), 39-43.
- Boyer, W., & Crippen, C. L. (2014). Learning and Teaching in the 21st Century: An Education Plan for the New Millennium Developed in British Columbia, Canada. *Childhood Education*, 90(5), 343-353.
- Brotosiswoyo, B. S. (2001). Hakikat Pembelajaran MIPA dan Kiat Pembelajaran Kimia di Perguruan Tinggi. In *Hakikat Pembelajaran MIPA di Perguruan Tinggi*. Jakarta: PAU-PPAT DIKTI Depdiknas RI.
- Cai, H., Gu, X., & Wong, L. H. (2017). An Investigation of Twenty-First Century Learners' Competencies in China. *Asia Pacific Education Review*, 8(2), 475-486.
- Cecilia, K., Chan, Y., Emily, T., Fong, Y., Lillian Y., Luk, Y., & Ho. R. (2017). A Review of Literature on Challenges in the Development and Implementation of Generic Competencies in Higher Education Curriculum. *International Journal of Educational Development* 57, 1-10.
- Coil, D., Wenderoth, M. P., Cunningham, M., & Dirks, C. (2010). Teaching the Process of Science: Faculty Perceptions and An Effective Methodology. *CBE—Life Sciences Education*, 9, 524-535.
- Colley, K. E. (2010). Understanding Ecology Content Knowledge and Acquiring Science Process Skills through Project-based Science Instruction. *Science Activities: Classroom Projects and Curriculum Ideas*, 43(1), 26-33.
- Creswell, J. W. (2014). *Research Design: Qualitative, Quantitative, and Mixed Methods Approaches* (4th ed.). California: SAGE Publication, Inc.
- DiCerbo, K. (2014). Assessment and Teaching of 21st Century Skills. *Assessment in Education: Principles, Policy & Practice*, 21(4), 502-505.
- Duran, E., Yaussy, D., & Yaussy, L. (2011). Race to the Future: Integrating 21st Century Skills into Science Instruction. *Science Activities: Classroom Projects and Curriculum Ideas*, 48(3), 98-106.
- Durmaz, H., & Mutlu, S. (2017). The Effect of An Instructional Intervention on Elementary Students' Science Process Skills. *The Journal of Educational Research*, 110(4), 433-445.
- Ercikan, K., & Oliveri, M. E. (2016). In Search of Validity Evidence in Support of the Interpretation and Use of Assessments of Complex Constructs: Discussion of Research on Assessing 21st Century Skills. *Applied Measurement in Education*, 29(4), 310-318.
- Fry, S., & Seely, S. (2011). Enhancing pre-Service Elementary Teachers' 21st-Century Information and Media Literacy Skills. *Action in Teacher Education*, 33(2), 206-218.
- Geisinger, K. F. (2016). 21st Century Skills: What are They and How Do We Assess Them? *Applied Measurement in Education*, 29(4), 245-249.
- George, R. (2011). Fostering Generic Skills through Participatory Learning Strategies. *International*

- Journal of Fundamental Psychology & Social Sciences*, 1(1), 14-16.
- Gray, K., & Koncz, A. (2014). *The Skills/Qualities Employers want in New College Graduate Hires. Job Outlook 2015*. Bethlehem, PA: National Association of Colleges and Employers.
- Greenstein, L. (2012). *Assesing 21st Century Skill. A Guide to Evaluating Mastery and Authentic Learning*. California: SAGE Company.
- Griffin, P. (2017). Assessing and Teaching 21st Century Skills: Collaborative Problem Solving as A Case Study. *Innovative Assessment of Collaboration*, 113-134.
- Haviz, M. (2015). Cooperative Learning Model on Developmental of Biology. *American Journal of Educational Research*, 3(10), 1298-1304.
- Haviz, M. (2016). Designing and Developing the Integrated Learning Model on Embryology. *Pennsylvania Review*, 24(7), 1043-1052.
- Jääskelä, P., Nykänen, S., & Tynjälä, P. (2016). Models for the Development of Generic Skills in Finnish Higher Education. *Journal of Further and Higher Education*, 42(1), 130-142.
- Jang, H. (2016). Identifying 21st Century STEM Competencies Using Workplace Data. *Journal of Science Education and Technology*, 25(2), 284-301.
- Jia, Y., Oh, Y. J., Sibuma, B., & Lorentson, M. (2016). Measuring Twenty-First Century Skills: Development and Validation of a Scale for in-Service and pre-Service Teachers. *Teacher Development: An international Journal of Teachers' Professional Development*, 20(2), 229-252.
- Joseph, C., So, H., Derek S., & Lam, Y. (2015). Relationship between Student Development Activities and Core Generic Competencies among Tertiary Science and Technology Students. *Teaching Assessment and Learning for Engineering (TALE) IEEE International Conference*, 207-214.
- Kaufman, K. J. (2013). 21 Ways to 21st Century Skills: Why Students Need Them and Ideas for Practical Implementation. *Kappa Delta Pi Record*, 49(2), 78-83.
- Kinchin, I. M. (2010). Effective Teacher □ Student Dialogue: A Model from Biological Education. *Journal of Biological Education*, 37(3), 110-113.
- Kinchin, I. M. (2011). Visualising Knowledge Structures in Biology: Discipline, Curriculum and Student Understanding. *Journal of Biological Education*, 45(4), 183-189.
- Koksal, E. A., & Berberoglu, G. (2014). The Effect of Guided-Inquiry Instruction on 6th Grade Turkish Students' Achievement, Science Process Skills, and Attitudes Toward Science. *International Journal of Science Education*, 36(1), 66-78.
- Lambert, J., & Gong, Y. (2010). 21st Century Paradigms for pre-Service Teacher Technology Preparation. *Computers in the Schools Interdisciplinary Journal of Practice, Theory and Applied Research*, 27(1), 54-70.
- Larson, L. C., & Miller, T. N. (2011). 21st Century Skills: Prepare Students for the Future. *Kappa Delta Pi Record*, 47(3), 121-123.
- Molefe, L., & Stears, M. (2014). Rhetoric and Reality: Science Teacher Educators' Views and Practice Regarding Science Process Skills. *African Journal of Research in Mathematics, Science and Technology Education*, 18(3), 219-230.
- Muhammad, A., & Osman, K. (2010). Inventive Thinking Skills in Science: A Comparative Study between Students in Malaysia and Brunei. *International Journal of Learning*, 17(9), 227-236.
- Mulyani, S., Liliyasi, Wiji, Hana, M. N., & Nursa'adah, E. (2016). Improving Students' Generic Skill in Science through Chemistry Learning Using ICT-based Media on Reaction Rate and Osmotic Pressure Material. *Jurnal Pendidikan IPA Indonesia*, 5(1), 150-156.
- Natoli, R., Jackling, B., & Seelanatha, L. (2014). The Impact of Instructor's Group Management Strategies on Students' Attitudes to Group Work and Generic Skill Development. *Pedagogies: An International Journal*, 9(2), 116-132.
- Rahman, T. (2008). *Pengembangan Program Pembelajaran Praktikum untuk Meningkatkan Kemampuan Generik Calon Guru Biologi*. Bandung: Universitas Pendidikan Indonesia.
- Regulation of the Minister of Education and Culture of the Republic of Indonesia Number 22 of 2016.
- Rhee, B. S., & Kim, S. (2012). Differential Pathways to Generic Skills Development of Male and Female College Students in Korea. *Asia Pacific Education Review*, 13 (4), 677-690.
- Sang, G., Liang, J.-C., Chai, C. S., Dong, Y., & Tsai, C. C. (2018). Teachers' Actual and Preferred Perceptions of Twenty-First Century Learning Competencies: A Chinese Perspective. *Asia Pacific Education Review*, 19(3), 307-317.
- Savitri, E. N., Wusqo, I. U., Ardhi, M. W., & Putra, P. D. (2017). Enhancement of Science Students' Process Skills through Implementation of Green Learning Method (GeLeM) with Conservation-based Inquiry Approach. *Jurnal Pendidikan IPA Indonesia*, 6(2), 237-244.
- Schenzel, J. E. (2013). *Teachers and Decision made in the Process of Developing a Formal Curriculum* (Masters thesis).
- Sibille, K., Greene, A., & Bush, J. P. (2010). Preparing Physicians for the 21st Century: Targeting Communication Skills and the Promotion of Health Behavior Change. *Annals of Behavioral Science and Medical Education*, 16(1), 7-13.
- Stone, E. M. (2014). Guiding Students to Develop An Understanding of Scientific Inquiry: A Science Skills Approach to Instruction and Assessment. *CBE—Life Sciences Education*, 13, 90-101.
- Tiruneh, T. D., Weldeclassie, A. G., Kassa, A., Tefera, Z., Cock, D., & Elen, J. (2016). Systematic Design of Learning Environment for Domain-Specific and Domain-General Critical Thinking Skill. *Educational Technology Research and Development*, 64(3), 481-505.
- Umar, A. A., Saad, S. K., Umar, M. I., Rahman, M. Y., & Oyama, M. (2018). Advances in Porous

- and High-Energy (001)-Faceted Anatase TiO₂ Nanostructures. *Optical Materials*, 75, 390-430.
- Umar, M. I., Yap, C. C., Awang, R., Umar, A. A., & Salleh, M. M. (2013). Formation of Gold-Coated Multilayer Graphene via Thermal Reduction. *Materials Letters*, 106(1), 200-203.
- Umar, M. I., Yap, C. C., Awang, R., & Salleh, M. M. (2017). Effect of Thermal Reduction Temperature on the Optical and Electrical Properties of Multilayer Graphene. *Journal of Materials Science: Materials in Electronics*, 28(1), 1038-1041.
- Umar, M. I., Yap, C. C., Awang, R., Umar, A. A., Salleh, M. M., & Yahaya, M. (2013). Characterization of Multilayer Graphene Prepared from Short-Time Processed Graphite Oxide Flake. *Journal of Materials Science: Materials in Electronics*, 24(4), 1282-1286.
- Walters, Y. B., & Soyibo, K. (2010). An Analysis of High School Students' Performance on Five Integrated Science Process Skills. *Research in Science & Technological Education*, 19(2), 133-145.



MODELING OF CULTURAL EFFECT ON SCHOOL AUTONOMY AT RELIGION-BASED SCHOOL IN INDONESIA

M. J. Susilo*¹, B. Kartowagiran², R. Vehachart³

¹Department of Biology Education, Faculty of Teacher Training and Education,
Ahmad Dahlan University, Yogyakarta, Indonesia

²Department of Research and Education Evaluation, Yogyakarta State University, Yogyakarta, Indonesia

³Department of Administrative Education, Thaksin University, Thailand

DOI: 10.15294/jpii.v7i3.12445

Accepted: January 23rd 2018. Approved: February 15th 2018. Published: September 20th, 2018

ABSTRACT

School culture may have an influence on the school community. Effective school culture leads to success in accordance with values, professionalism and building school autonomy. This research aimed to develop a model of school culture that has an impact on the school autonomy. The subjects were school foundation committees, principals, teachers, staff, and students. The study was conducted in four private junior high schools managed by the Muhammadiyah foundation in Indonesia. Data were collected through interviews, questionnaires, and documentation. School culture consists of formal, sociable-dynamic, and prosperity sub-components. The results showed that culture (Cul) influenced school autonomy (Kms) in 2 ways, direct and indirect effect. The direct effects scored 0.002 and 0.32 for the indirect effect. It meant that culture gave a small contribution (0.32%) to create school autonomy while the other 0.99% came from other factors. Schools culture provided a role play to create school autonomy. Those establishing the independence of Muhammadiyah schools are formal, sociable dynamic, and prosperity. School culture contributed to the effectiveness of school management and developed positive internal habits resulting in effective and efficient school goals.

© 2018 Science Education Study Program FMIPA UNNES Semarang

Keywords: Muhammadiyah, school, culture, autonomy, private

INTRODUCTION

As a mini-society, school have a duty to prepare their student to become future generation, who are stand alone, adult, and prepared carry on the live estafette cane. Hence, schools need to create a positive and fresh atmosphere by cultivating favorable school culture in order to facilitate school improvement (Furkan, 2014; Susilo, 2017b).

Actually, such a process is not that tiresome as long as all school members have high awareness to achieve best school quality. As a starting point, building positive school culture, keeping a harmonious atmosphere, raising up awareness among school member, and implementing the environmental education such as maintaining either personal or classroom hygiene (Zaenuri et al., 2017). Schools having the administrative, decision-making, budgeting, and administrator control are so-called the autonomous schools (Masino & Niño-Zarazúab, 2016). However, the concept of

*Correspondence Address
E-mail: jokoms.uad@gmail.com

autonomous school does not merely mean to be fully independent since it needs public supports (Caldwell, 2014). The advantages of autonomous schools include: (1) raising up confidence among the school administrators in decision-making; (2) being innovative; (3) being up-to-date to the recent development in the education world; and (4) leading to become a progressive school.

Autonomous school is a major component of the education system that guarantees the quality of education (Fullan, 2001). The autonomous schools also intend to result in better outcomes for students. Educators who understand a school would know the appropriate treatment for their students. The teaching and learning provided by the schools is more independent and no longer depend on the central bureaucracy. This allows schools to make their own decisions about the school needs and policies (Scileanna, 2015).

In fact, there has never been any research on the independence of autonomous schools in Indonesia, yet it is important to distinguish between the independent, 'quite' independent, and 'not-quite' independent. The sustainability of this classification would be a foundation for the policy maker in decision-making. The fact underlying this is that the National Education Standard (SNP) being under all Indonesian schools. Schools have to pass out the standard to be stated as independent.

A research related to the classification of these schools has been carried out by PISA which classifies schools into three groups: (1) schools with relatively high levels of autonomy whose characteristics are more competitive, owning school management and development authority, as well as privilege in using learning methods; (2) schools with high levels of autonomy, but low competitiveness. Despite having authority to make policies, schools in this category have low public interest; and (3) schools with relatively low levels of autonomy, but have a high incentive to compete with other schools (OECD, 2014).

The strength of an autonomous school is essential to know before devolving powers to the school. As stated by Main (2009), a school's success or failure can be measured through the formed school culture whether or not it is accepted by school members, effective, and sustainable. Caldwell (2014) mentioned that autonomous school is an "innovation zones". There are may be an impact on students' achievement in a certain area in which these schools specialize. Thus, to this extent, there is an association with the degree of school autonomy. Glušac et al., 2015; Hongboontri & Keawkhong, 2014).

Principals thought that leading an autonomous school enables to drive a school culture that emphasizing high expectations of students and staff, teachers as professionals, collaboration focussing on the improvement of classroom practice, norms, responsibility and problem solving where mistakes and problems were responded by a search for better strategies rather than by excuses for students' lack of progress (Chance & Segura, 2009; Prokopchuk, 2016; Purwoko et al., 2017).

School culture is the dominant values embraced by a school. It is the philosophy underlying the school policies for all the school elements and components in carrying out the duties. Furthermore, it also signifies the assumptions or beliefs held by the school members (Meier, 2012). In addition, Zamroni (2007) defined school culture as the patterns of basic assumptions, system of values, beliefs, and customs as well as various products of schools that encourage the school members to cooperate on the basis of trust which invite all members to contribute to new ideas and provide opportunities to renew the schools.

School culture, indeed, influences the behavior of the school members. It results in changing the mindset of the educators towards the students, the mindset of the educational staffs towards their duties (work effectiveness), and other things related to the establishment of school autonomy. As stated by Abdullah & Arokiasamy (2016), school culture influences job satisfaction. Strong-cultures schools have proven to gain better teacher motivation. The highly-motivated teachers are more likely to succeed in improving student performance and learning outcomes (MacNeil et al., 2009).

School culture is seen as the existence of a school which involves the interplay of three factors; attitude, beliefs, and norms of the school and of the surrounding environment. The effective school culture reflects the synergy of those three factors. It leads to the success of the program implemented according to humanistic, professionalism and empowering values. In the effective schools, the members are satisfied by the relationship among others resulting in the decline to leave the school (Nurhafifah, 2016). Hence, autonomy, as a form of independence, would be easily established. Further, autonomy is required by an institution or a school to achieve their excellences, which thereby leads them to achieve a good quality school.

The variable of culture, which are mostly found in Muhammadiyah, can be explained in three sub-components, those are formal culture,

sociable-dynamic culture, and prosperity culture (Zamroni, 2016). The formal culture refers to the habit developed by the school community, such as motivation for higher achievement, formal relationship according to the duties and responsibilities, and rather rigid and less conducive working atmosphere. For a certain extent, the formal culture is required for schools that are in progress to internalize their norms as to develop the expected positive habits. The sociable-dynamic culture defines as informal relationships developed by the school community as their daily habits. This way, the school members are more optimistic and independent in embracing their future. The prosperity culture shows the way the school community interacts in an intimate, warm, and sociable atmosphere. Togetherness and the spirit of helping each other are seen in the harmonious working atmosphere.

Referring to those cultures, it is necessary to develop a model of school culture that has an impact on the school autonomy. School culture influences the direction of school as it forms a school model. For example, the school culture developed in Taruna Nusantara Magelang High School in the form of military discipline resulting in highly-discipline students. If a school builds an entrepreneurial culture, it will produce reliable entrepreneurs as applied in Ciputra schools. If a school builds a religious culture, it will form a model of pesantren school that can produce 'ulama', or moderate people such as Mualimin, Mualimat just like in MBS (Muhammadiyah Boarding School). In other words, the independence of school basically builds an independent culture which is able to grow the self-potential of the school and empowers this potential for school progress. Therefore, this study would contribute to the improvement of school quality especially in Muhammadiyah schools, also, enrich educators' references about school models.

METHODS

This research was a developmental research referring to the model of Design and Development Research (DDR) by Richey & Klein (2007), as well as the model proposed by Cennamo & Kalk (2005). Both of these models complement each other in the research stages. DDR, according to Richey & Klein (2007), covers four stages, those are 1) model development; 2) model internal validation; 3) model external validation, and 4) model use. Meanwhile, Cennamo & Kalk (2005) developed five stages, those are: Define, Design, Demonstrate, Develop, and Delivery.

This research method was a modification of the two models adapted to the stages in this study. Further, the models were called as LCBT evaluation model developed in 4 (four) stages including: (1) defining/collecting data to make theoretical construct autonomy model; (2) designing/making prototype model; (3) developing/making autonomy model through theoretical construction and validation/model testing including the internal validation; and (4) using/implementation of autonomy model on the external validation.

The subjects were the foundation committee, principals, teachers, staffs, and students. The research was located in four junior high schools belonging to Muhammadiyah Foundation in Sleman Regency, Yogyakarta, Indonesia: SMP Muhammadiyah 1 Gamping, SMP Muhammadiyah 1 Minggir, SMP Muhammadiyah 2 Kalasan, and SMP Muhammadiyah 3 Depok. All these religion-based schools insert the religion values to the national curriculum. The data were collected through interview, questionnaire, and documentation.

The data were analyzed using a descriptive qualitative with triangulation data and quantitative techniques by Lisrel program 8.80 version. The qualitative technique consists of 2 steps: first, model test results with CFA, to analyze the contribution of each indicator toward the component and sub-component. Second, model test results with SEM (Structural Equation Modeling) to analyze the model in its entirety. The goals of the analysis and test were to determine the fit model and hypothesis test. The model would be said fit after fulfilling the chi square index ($\chi^2 \leq 2df$), $P\text{-value} \geq 0.05$, and root mean square error of approximation ($RMSEA \leq 0.08$) (Ghozali & Fuad, 2012).

RESULTS AND DISCUSSION

A positive school culture supports hard work and high achievement. Conversely, a bad culture will lead to the avoidance towards the school. Further, the community's interest in sending their children to the school would decrease. A positive culture as stated by Kaplan & Owings (2013), have the following characteristics: (1) embracing inspiring vision and mission; (2) possessing the main leadership that encourages teachers, staff, students and parents to fully support the vision and mission; (3) innovative and risk-taking principals, teachers, and staff; (4) high expectations from each school member; (5) trust and confidence of teachers, staff, students and parents; (6) improved performance of each

school member; (7) actively participated school members and stakeholders; (8) honest, open communication; (9) support from school members contributing to the welfare of the school; and (10) awards and recognition. On the other hand, some schools could also pursue a bad culture. Referring to Zamroni (2016), a negative school culture might be caused by a poor teacher cooperation which leads to the decrease of teachers' performance resulting in less professional service and unsatisfactory learning outcomes (Ohlson et al., 2016). Culture, as one of the aspects in LCBT (Leadership, Culture, Backing, and Transactional) model, is interesting to be studied deeper

since it plays strategic role in developing positive habits of the school in order to achieve the desired goals. As stated by Zamroni (2016), school culture is shaped by the community's behaviour internalized in their daily activities, which thereby develops their own habits. School culture is a distinctive and unique tradition that is built from time to time by school members, including teachers, students, parents, and the community (Hongboontri & Keawkhong, 2014). The following Table 1 elucidates that school culture consists of three sub-components; formal sub-component (Fr), sociable-dynamic sub-component (Ad), and prosperity sub-component (Mh).

Table 1. Sub-Component and Indicators of School Culture

Sub-component	Indicators	Code
Formal	Motivation for higher achievement	Fr1
	Formal/Rigid relation	Fr2
	Tied to duties and responsibilities	Fr3
	Less having positive effects	Fr4
Sociable-Dynamic	Highly sociable and humane relations	Ad1, Ad2
	Informal and meaningful	Ad3
	More optimistic, independent	Ad4, Ad5
Prosperity	Relations among community members	Mh1
	Warm and humane interaction	Mh2
	Spirit of togetherness and helping each other	Mh3
	Easily satisfied	Mh4

Modeling Test Results with CFA (Confirmatory Factor Analysis)

CFA is a restricted factor analysis (Hoyle, 2000), measurement models where the researcher must explicitly specify the indicator-factor correspondence (Kline, 2013). CFA provides a more ex-

PLICIT framework confirming prior notions about the structure of a domain of content (Steiger, 2013). According to the model test results with *confirmatory factor analysis* method, it is known that each sub-component influences the school autonomy, as reflected in Figure 1.

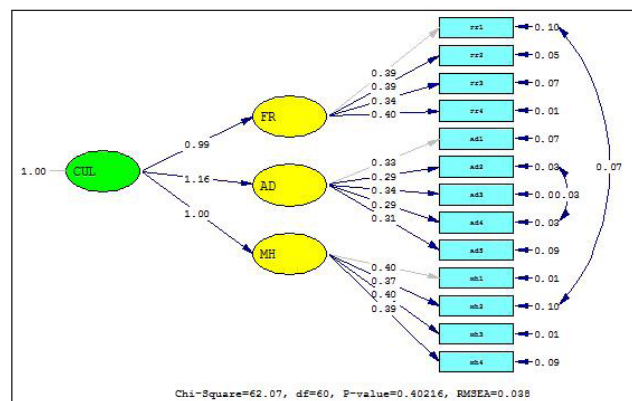


Figure 1. Conceptual Model (Standardized Solution) of School Cultures

The figure shows that the modification of error covariance based on relations among community members indicator (Fr1) with warm and human interaction (Mh2). The *Chi square* (χ^2)

was less than 2df, ($62,07 < 2(60)$), while the probability χ^2 fulfilled the criteria having the score of $>0,05$ ($p\text{-value} = 0.40216$), and the *root mean square error of approximation* which was less than 0,08

(0,038). After serving the *error covariance* between the motivation for higher achievement (Fr1) with the warm and humane interaction (Mh2) and the highly sociable and humane relations (Ad2) with the indicator of optimistic and independent (Ad4). Thus, it showed the correlation between the motivation for higher achievement (Fr1) with warm and humane interaction (Mh2) and the highly sociable and humane relations (Ad2) with the indicator of optimistic, independent (Ad4). It meant that the warm and humane interaction would grow positive motivation for higher achievement. Thus, people would be more optimistic and independent when they are related to others in a warm, humane interaction. Based on the conceptual model of school culture, we knew that: 1) the contribution number of the indicator Fr1, Fr2, Fr3, and Fr4 towards the subcomponent of formal (Fr) was 0.39(Fr1), 0.39 (Fr2), 0.34 (Fr3), and 0.40 (Fr4); 2) the contribution number of the

indicator Ad1, Ad2, Ad3, Ad4, and Ad5 towards the subcomponent of sociable-dynamic (Ad) was 0.33 (Ad1), 0.29 (Ad2), 0.34 (Ad3), 0.29 (Ad4) and 0.31 (Ad5); 3) the contribution number of the indicator Mh1, Mh2, Mh3, and Mh5 toward the subcomponent of prosperity (Mh) was 0.40 (Mh1), 0.37 (Mh2), 0.40 (Mh3) and 0.39 (Mh4). Moreover, the contribution of every subcomponent toward its component was 0.99 (Fr), 1.16 (Ad), and 1.00 (Mh).

Beside the *loading factor*, the analysis results also pointed out that the significant relation between the indicators as the *observed components* with subcomponents as the *endogenous latent variable*, as well as the essential relation between the subcomponents as the *endogenous latent variable* with the components as the *exogenous latent variable* indicated the existence of significant relation between the *observed components* (every indicator) with its *latent component* (Figure. 2)

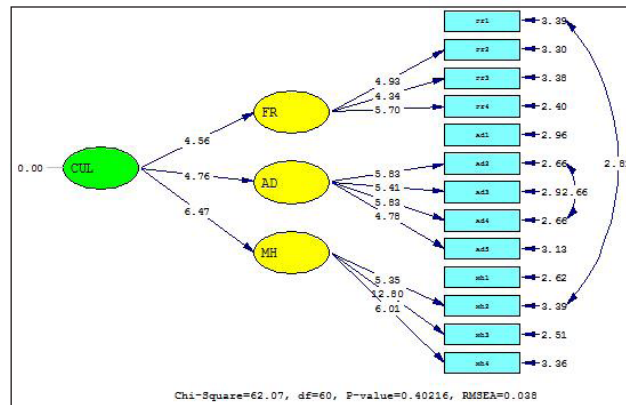


Figure 2. The Conceptual Model (t-values) of School Cultures

The t-test (*t-values*) results as in Figure 2 shows that all indicators with subcomponents, and all subcomponents with components achieved the significant criteria ($t > 1,96$), which meant that the asserted hypothesis model had *goodness of fit statistics*.

Modeling Test Results with SEM (Structural Equation Modeling)

SEM technique for estimating restricted measurement models (Kline, 2013). According to the model test results with SEM (*Structural Equation Modeling*) method, it is known that each subcomponent influences the school autonomy, as reflected in Figure 3.

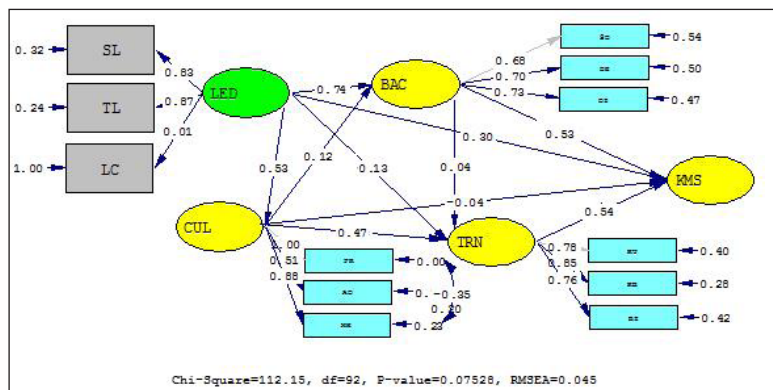


Figure 3. The Influence of School Culture towards the School Autonomy

The figure 3 informs that school autonomy model (KMS) reformed from the leadership (LED), culture (CUL), backing (BAC) and transactional (TRN) variables which then popularly abbreviated as LCBT evaluation model.

The variable of culture consists of three components; formal (Fr), sociable-dynamics (Ad), and prosperity (Mh) which indicated significant influences on the establishment of school autonomy. The *Chi square* (χ^2) = 112.15 < 2 (92), while the probability χ^2 was >0,05 (p = 0.07528), and the *root mean square error of approximation* was <0,08 (RMSEA=0,045). Based on those data, it was known that the LCBT model was the fit model. Thus, a possible correlation

existed between the role playing of principal leadership and the growth of positive school culture for every school members. This meant that favorable principal leadership had a strong influence in cultivating a independent habit of the school members.

Furthermore, the analysis of *factor loading* for every component and sub-component proved the contribution of the sub-components toward components and inter-components of LCBT. On the culture, especially, the contribution of subcomponents toward the culture was 1.00 (Fr), 0.51 (Ad), and 0.88 (Mh). The total effect of culture (Cul) towards the school autonomy (KMS) is presented in Table 2.

Table 2. The Total Effect of Inter-Component

Latent component	R	r ²	Direct Effect	Indirect Effect	Total effect
Led →Cul	0.53	0,28	0,28	-	0.28
Led→Bac	0.74	0.55	0.55	(0.53*0.12) = 0.06	0.61
Led→Trn	0.13	0.02	0.02	(0.53*0.47) + (0.74*0.04) = 0.28	0.30
Led→Kms	0.30	0.09	0.09	(0.53*0.04)+(0.53*0.47*0.54)+ (0.74*0.53) + (0.74*0.04*0.54) + (0.13*0.54) = 0.63	0.72
Cul→Bac	0.12	0.01	0.01	-	0.01
Cul→Trn	0.47	0.22	0.22	(0.12*0.94) = 0.005	0.23
Cul → Kms	0.04	0.002	0.002	(0.12*0.53) + (0.12*0.04*0.54) = 0.32	0.32
Bac→Trn	0.04	0.002	0.002	-	0.002
Bac → Kms	0.53	0.28	0.28	(0.04*0.54) = 0.02	0.30
Trn → Kms	0.54	0.29	0.29	-	0.29

Table 2 shows that culture (Cul) influenced the school autonomy (Kms) in 2 ways; direct and indirect effect. The direct effect scored 0.002 and the indirect effect scored 0.32. This explained that the culture gave a little (0.3%) contribution to create the school autonomy while the other 0.97% came from other factors. Overall, the largest influence was in the leadership (led) 0.72 at the direct effect.

Junior High Schools of Muhammadiyah, especially in Sleman Regency, Indonesia are highly prosperous, have a vigorous school-based management (SBM) quality, highly-discipline and excellent members led by influential principals. Coordination is an essential matter, held routinely by the school members with parents and community. The SBM has considerable potential to elicit positive changes in schools dealing with crises in terms of school management,

funding, directing teachers and staff, efficient use of resources, management of lesson plan and syllabi, and improving the quality of education (Kiragu et al., 2013)the accrued benefits of SBM and challenges schools would experience if SBM was introduced in Murang'a South district. The study adopted descriptive survey design. Stratified sampling was used to select 16 schools which participated in this study. A sample of 80 respondents was selected to participate in the study. The sample for the study included 64 teachers and 16 principals. Data for this study was collected using structured questionnaires which were administered by the researcher to a sample of principals and teachers in each of the sampled schools. A pre-testing of the research tools was carried out in four institutions which were not included in the study to ascertain validity and reliability of the instrument. The data was analysed manually

and was presented in descriptive statistical tables using frequencies and percentages. The result of findings indicated that the introduction of SBM would be a way of addressing the current crisis in management of secondary schools, bringing about accountability, commitment by teachers in discharging their duties, efficient use of resources, timely syllabus coverage, delivery of quality education, improve efficiency and reduce need for supervision among other prospects if it was introduced in secondary schools in the district. The study made the following recommendations: Firstly, principals and teachers should be actively involved in making decisions about secondary schools management because they are the people on the ground and understands the school environment better. Secondly, the Ministry of Education should consider involving all the education stakeholders in formulating policies, this way they will own the policies and it will be easy to implement them without being seen like they are forcing them on schools (Kiragu, King'oina, & Migosi, 2013).

The SBM is a form of education responsibility in managing school policies, academics as well as regulating individuals and school members including principals, teachers, staff, students and the local community (Vernez et al., 2012). It is expected that there will be a policy making through joint-deliberation based on the local wisdom. In other words, the SBM is the authority given to autonomous school boards to design, implement, and manage education programs in accordance with local norms and culture. Zamroni (2007) argued that school culture could also be studied based on two aspects in the school daily activities; the students' motivation for higher achievement and togetherness among school community.

The strength of school autonomy level in school management has a positive impact on school leadership and the quality of education (Weinstein & Muñoz, 2014). A good school culture is not free from leadership play role, where leader makes trust and collaborates with staffs to share school visions, clear management flow, and leadership strengths in developing programs (Bush & Glover, 2014). Overall, leadership requires a flexible strategy, more than that, attention to leadership in learning, program development, and staff management to achieve a successful school (Bush & Glover, 2014).

School culture also influences the formation of good school support (Bac). As stated by Cansoy & Parlar (2017), the increase of support in the form of teacher leadership related to or-

ganizational development could be done through the establishment of a collaborative relationship between principals, teachers, and students. A great teacher supports the students as a form of learning culture has the opportunity to improve the students' academic achievement and realize school autonomy (Lu et al., 2015; Rodríguez et al., 2017).

The last variable is transactional (Trn), in which the implementation does not simply deliver the subject matter knowledge and prepare the students for their future professional careers. As stated by AACTE (2010); Burnaford et al. (2007), educational goals in the 21st-century to make the students more active, independent, confident, and concerned on cognitive, emotional, social, and technological. This good culture is created through effective teachers with professional development (Bautista & Ortega-Ruiz, 2015). In addition, the principal's leadership style also plays a role as a catalyst for school change, student growth, teacher procurement, and school culture (Troutman, 2012).

Besides, culture is also influential in the establishment of school autonomy. It is an organization with its own culture, which forms a whole and unique system. The characteristics of school culture cannot be separated from the vision and the ongoing education processes that require the existence of the elements or the components of the school as the working area of the organization. The elements interact and are interrelated. In certain ways, a particular culture is internalized continuously. In other words, culture needs improvement. Sometimes, it has to be removed and replaced with another one.

Schools can be more autonomous in various forms. In the US schools, autonomous financing management (AFM) is carried out by recruiting and training teachers, holding school facilities, infrastructure, materials, equipment, and educational books, manage operational costs, as well as seeking additional funds. In the UK, AFM is carried out by hiring, firing, training teachers, managing and maintaining facilities, buying school supplies, books, doing service, obtaining and managing additional funds. In the European Union, the majority of countries implement AFM by managing daily operational costs, offering additional compensation to the teacher, facilitating schools, while minority countries do AFM by buying school equipment and obtaining additional funds. In Australia, AFM is carried out by selecting and compensating personnel, facilitating school, buying equipment, books, managing operational costs,

also, obtain and manage additional school funds (Theodorou, 2013; Theodorou & Pashiardis, 2016). The increasing level of school autonomy has the potential to produce better educational outcomes.

Muhammadiyah private schools own unique school cultures. Its school culture is an element to create school autonomy. According to Daulai (2017) school cultures of Muhammadiyah education in North Sumatra comprise (a) embedding the Muhammadiyah ideology in schools; (b) using Muhammadiyah symbols; (c) orienting to faith, knowledge, and charity in educational environment; (d) applying the edu-

cation curriculum, amaliyah, scientific deeds or scholars' intellect; (e) having vigorous work ethics; and (f) forming an organizational committee namely the Muhammadiyah Organization.

In general, the cultural characteristics of Muhammadiyah schools in various places are the same. Characteristics of school culture in Muhammadiyah private school especially in Sleman Regency, Yogyakarta, Indonesia can be classified into 7 categories: (1) Al-Islam and Muhammadiyah ideology; (2) nationalistic concept; (3) academic and skills; (4) school police & facility; (5) curriculum; (6) teaching and learning process; and (7) accounting (see Table 3).

Table 3. The Characteristics of School Culture in Muhammadiyah Private School

No	Categories	Characteristics of school culture
1.	Al-Islam and Muhammadiyah ideology	Welcoming the students' arrival 5S program (smile, greetings, peace, respectful, polite) Doing the Dhuha prayer Doing the Dhuhr & Asr prayer Doing the Friday prayer Friday-Cleaning program Al-Islam and Muhammadiyah ideology Interpreting al-Qur'an Infaq every Friday Sympathetic care Celebrating Islamic holidays Implementing the Ramadhan Islamic boarding school Conducting zakat fitrah and religious offering (qurban) Conducting class recitations every month Conducting social service to the dhu'afa Series of quarantine activities before the exam "(Tahajud call, material deepening test MKKS and BKS, etc.) Tahajud call, training test Tahsin Reading Al-Qur'an before teaching and learning process Murajaah/memorizing short pray
2.	Nationalistic concept	Singing national songs before and after teaching and learning Singing the Muhammadiyah anthem Having flag ceremony every Monday Commemorating the National Day ceremonies
3.	Academic & Skills	Intensive subject matter Guidance National Science Olympiad Extracurricular activities (Hisbul Wathan, OSIS, IPM, etc.) KIR (teenager's Scientific paper) Additional lesson English club Arabic Student exchange Cooperation with foreign countries Extracurricular activities (ICT, Electronics, and Robotics)
4.	School police & facility	Student admission Providing a bus school Rewarding (student savings/safety) Scholarship for teachers, staff, and students Education unit School parenting Gender equality Counseling assistance Post-national program (analyzing the results of the national examination) Establish cooperation with other institutions (e.g. insurance service, universities, LPTK organizers, etc.) AUM care AUM sharing

5.	Curriculum	Persyarikatan (Union)-Based Management Tawheed-based curriculum Mandatory local content (e.g., Java Language, batik) Self-development program Environment education and disaster mitigation (SWALIBA) Implementing the gender equality education Traffic ethnics education Conducting education life- skills
6.	Teaching and Learning Process	Full day school program Life skill education
7.	Accounting	Having the BUMS (School-Owned Enterprise) Cross-subsidy payment system Transparency and accountability Collection of loyal funds

The school members (principals, teachers, staff) are used to welcome the students every morning with the spirit of 5S (smile, greeting, peace, respectful, good manner). They also always get used to doing the dhuha prayer and dhuhur prayer in congregation. The school also has a policy for literacy before the lesson begins. Literacy includes: reading Al-Qur'an, murajaah/ memorizing short pray, singing national songs and Muhammadiyah anthem. Muhammadiyah schools adopt the national curriculum and ISMUBA (Al-Islam, Kemuhammadiyah, and Arabic). Although it is an Islamic-based school, it keeps abreast of the times such as: cooperating with other countries, holding student exchanges, organizing extracurricular Technology Information, Electronica, and Robotics.

To attract public sympathy, Muhammadiyah schools have a special strategy during the new students admission with a systemic system, free of charge and uniform; providing rewards for school residents, outstanding students and disadvantaged students, development of superior school programs such as Adiwiyata school, MBS (Muhammadiyah Boarding School), etc., and establishing the BUMS/M (school/madrasah-owned business entity) in the form of a canteen, Kapas 2 Mart, chartering business as done in Sapen and SMP Muhammadiyah 2 Yogyakarta. Besides, there are also boarding schools such as Islamic boarding schools in SMA Muhammadiyah 1 Yogyakarta.

The success of implementing school autonomy does not only depend on functional and structural changes, but also on changes in school culture. As stated by Jurasait-Harbison & Rex (2010), those cultural qualities of schools supported learning quality as a method of continuing professional development.

Muhammadiyah private school is a unique school with characteristics based on Islamic culture, for example, implementation of Al-Qur'an

and Muhammadiyah ideology as its vision and mission, and also have missionary mandate called "Amar ma'ruf Nahi Munkar". Therefore, all of the school members are directed to the attainment of its vision and mission, include teaching and learning, curriculum, accounting, extracurricular, and etc. The culture, as a specific characteristic of Muhammadiyah school, differentiates from other schools both private and public school.

Referring to Susilo (2016, 2017a), the characteristics of Muhammadiyah autonomy schools includes: (a) worship (al-Islam) order; (b) proficient reading and writing the Quran; (c) a national paradigm; (d) highly academic knowledge; (e) foreign languages skills; and (f) computer skills. on the other side, the autonomies in Muhammadiyah school management comprise independent curriculum, learning and teaching, educators, funding and school facilities.

In Madrasah Mu'allimaat Muhammadiyah Yogyakarta, holistic education in the multilingual program really appreciates the four quotients; SQ, EQ, IQ, and AQ. The internalization of holistic education in daily activities integrated between madrasah and boarding involving Tahajud prayer, preparation and performing Subuh prayer, doing sport, cleaning the environment, Ashar prayer, extracurricular or optional, preparation and performing Maghrib prayer, performing Isya' prayer together and reading al-Qur'an (Sutarman et al., 2017).

Every school has its own characteristics of culture, for example, in SMA Negeri 1 Dompu and SMA Negeri 1 Kilo. The role of the principal as a leader is able to build a positive culture that has an impact on character building through school culture, among other things embodied in caring for cleanliness, beauty, tidiness, observance of religious service, conformity to the rules, mutual respect, politeness, and family-like relationships, honesty and responsibility, togetherness, favorable document filing, and stakeholder

participation (Furkan, 2014).

In Chile, to manage their registration as an act to make school autonomy, efforts are carried out such as (1) redesigning examples of school institutional images such as new uniforms, school logos, changing school appearance to attract more students; (2) monitoring attendance; (3) collaborating with external organizations; (4) building relationships with parents and stakeholders; and (5) promoting schools (Montecinos et al., 2015).

All of the activities have been proven to encourage school culture reformation. The stronger the school culture, the better teacher motivation. High teacher motivation causes the increase in students' performance. Although there is no direct causal link between autonomy and school performance, rather, autonomy could have positive effects when accompanied by other interventions. As the OECD PISA reports (OECD, 2011), that when autonomy and accountability are intelligently combined, they tend to be associated with better student performance. Similarly, come French et al. (2014) argued that Autonomy doesn't equate to success. It creates the condition for success.

Hence, the implementation of school culture in every public or private school will establish a certain value system followed by all school members, lead to conducive, comfortable atmosphere to achieve the desired goals as a group. It is in relation to the message delivered by Langgulung (2007) that school culture refers to the particular system of values, beliefs, and norms accepted as a group, as well as implemented in full awareness as natural behavior, shaped by the environment that creates mutual understanding among the elements and members of the school, including the headmasters, teachers, staffs, and students. If necessary, the school is required to share the opinion with the communities.

Habits internalized in each school member will contribute to the effective management of the components. Thus, the desired achievements of each component will become the excellence of the school. Professionalism in working in the form of hard work, smart work, sincere work, and excellent (Mumtaz) work are internalized in the heart of every school member. They will see that working in Muhammadiyah school means to carry out the commands to do da'wah for the purpose of teaching the Indonesian people. It is the characteristic of effective school that effective school brings the qualities internalized in each school member, thus, reflecting professionalism to their behavior. Quality cultures consists of 1)

information provided for improvement instead of assessing or controlling quality people; 2) responsible authority; 3) the presence of a gift or punishment; 4) cooperation on the basis of collaborating and synergizing, not competing; 5) school members feel safe; 6) justice is upheld; and 7) school members have a sense of ownership of the school.

CONCLUSION

Based on the study, it concluded that culture (Cul) influenced school autonomy (Kms) in 2 ways, direct and indirect effect. The direct effects scored 0.002 and 0.32 for the indirect effects. It means that culture gave a small contribution (0.32%) to create school autonomy and the other 0.99% came from other factors. Schools culture provides a role play to create school autonomy. Those establishing the independence of Muhammadiyah schools are formal, sociable dynamic, and prosperity. School culture contributes to the effectiveness of school management and develops positive internal habits that result in effective and efficient school goals.

REFERENCES

- AACTE. (2010). *21st Century Knowledge And Skills In Educator Preparation*. US. Retrieved from http://www.p21.org/storage/documents/aacte_p21_whitepaper2010.pdf
- Abdullah, A. G. K., & Arokiasamy, A. R. A. (2016). The Influence of School Culture and Organizational Health ff Secondary School Teachers In Malaysia. *TEM Journal*, 5(1), 56–59.
- Bautista, A., & Ortega-Ruiz, R. (2015). Teacher Professional Development: International Perspectives and Approaches. *Psychology, Society and Education*, 7(3), 240–251.
- Burnafor, Brown, Doherty, & McLaughlin. (2007). *Arts Integration Frameworks, Research & Practice: A Literature Review*. Washington, DC: Arts Education Partnership.
- Bush, T., & Glover, D. (2014). School Leadership Models: What Do We Know? *School Leadership & Management*, 34(5), 553–571.
- Caldwell, B. J. (2014). *Impact of School Autonomy on Student Achievement in 21st Century Education* (Vol. 30).
- Cansoy, R., & Parlar, H. (2017). Examining The Relationship Between School Culture and Teacher Leadership. *International Online Journal of Educational Sciences*, 9(2), 310–322.
- Cennamo, K., & Kalk, D. (2005). *Real World Instructional Design*. Wadsworth/Thomson Learning.
- Chance, P. L., & Segura, S. N. (2009). A Rural High School's Collaborative Approach to School Improvement. *Journal of Research in Rural Educa-*

- tion (Online), 24(5), 1-10.
- Daulai, A. F. (2017). The Educational Culture of Muhammadiyah In North Sumatra. *IOSR Journal Of Humanities And Social Science (IOSR-JHSS)*, 22(3), 57-61.
- Firmaningsih-Kolu, Y. (2016). The Role of The Principal's Instructional Leadership at Schools In Indonesia. University of Jyväskylä.
- French, D., Miles, K. H., & Nathan, L. (2014). The Path Forward: School Autonomy and Its Implications for the Future of Boston's Public Schools. *Boston Foundation*.
- Fullan, M. (2001). *The New Meaning of Educational Change*. Routledge.
- Furkan, N. (2014). The Implementation of Character Education through The School Culture in SMA Negeri 1 Dompu and SMA Negeri Kilo Dompu Regency. *Journal of Literature, Languages and Linguistic*, 3, 15-17.
- Ghozali, I., & Fuad. (2012). *Structural Equation Modeling: Teori, Konsep, dan Aplikasi Dengan Program Lisrel 8.0*. Semarang: UNDIP Press.
- Glušac, D., Tasic, I., Nikolic, M., & Gligorovic, B. (2015). A Study of Impact of School Culture on The Teaching and Learning Process In Serbia Based on School Evaluation. *International Journal of Leadership in Education*, 12(2), 255-268.
- Hongboontri, C., & Keawkhong, N. (2014). School Culture: Teachers' Beliefs, Behaviors, And Instructional Practices. *Australian Journal of Teacher Education*, 39(5), 39-45.
- Hoyle, R. H. (2000). Confirmatory Factor Analysis. In *Handbook Of Applied Multivariate Statistics And Mathematical Modeling*. University of Kentucky, Lexington, Kentucky: Academic press. (pp. 465-497).
- Jurasaitė-Harbisson, E., & Rex, L. A. (2010). School Cultures As Contexts For Informal Teacher Learning. *Teaching and Teacher Education*, 26(2), 267-277.
- Kaplan, L. S., & Owings, W. A. (2013). *Culture Re-Boot: Reinvigorating School Culture to Improve Student Outcomes*. Thousand Oaks: Corwin Press.
- Kiragu, J. W., King'oina, J. O., & Migosi, J. A. (2013). School-Based Management Prospects and Challenges: A Case of Public Secondary Schools in Murang'a South District, Kenya. *International Journal of Asian Social Science*, 3(5), 1166-1179.
- Kline, R. (2013). Exploratory and Confirmatory Factor Analysis. In *Applied Quantitative Analysis in Education and The Social Sciences* (pp. 183-217). New York: Routledge.
- Langgulong, H. (2007). *Manusia dan Pendidikan*. Jakarta: Pustaka Al-Husna.
- Lu, J., Jiang, X., Yu, H., & Li, D. (2015). Building Collaborative Structures for Teachers' Autonomy and Self-Efficacy: The Mediating Role of Participative Management and Learning Culture. *School Effectiveness and School Improvement*, 26(2), 240-257.
- MacNeil, A. J., Prater, D. L., & Busch, S. (2009). The Effects of School Culture and Climate on Student Achievement. *International Journal of Leadership in Education*, 12(1), 73-84.
- Main, K. (2009). "Mind the gap": Cultural Revitalisation and Educational Change. *School Effectiveness and School Improvement*, 20(4), 457-478.
- Masino, S., & Niño-Zarazúa, M. (2016). What Works to Improve The Quality of Student Learning in Developing Countries? *International Journal of Educational Development*, 48, 53-65.
- Meier, L. T. (2012). The Effect of School Culture on Science Education at an Ideologically Innovative Elementary Magnet School: An Ethnographic Case Study. *Journal of Science Teacher Education*, 23(7), 805-822.
- Montecinos, C., Abumada, L., S., G., Campos, F., & Leiva, M. V. (2015). Targets, Threats, And (Dis) Trust: The Managerial Troika For Public School Principals In Chile. *Epaape*, 23(87), 2-29.
- Nurhaffah, N., Djasmis, S., & Ambarita, A. (2016). Pengaruh Kepala Sekolah Budaya Kinerja Guru terhadap Efektivitas Sekolah. *Jurnal Manajemen Mutu Pendidikan*, 4(3), 8-18.
- OECD. (2011). *School Autonomy and Accountability: Are They Related to Student Performance? PISA in Focus 2011/9*. Paris.
- OECD. (2014). *Lesson from PISA for Korea: Strong Performance and Successful Reformers in Education*. Korea: OECD Publishing. Pemkab.
- Ohlson, M., Swanson, A., Adams-Manning, A., & Byrd, A. (2016). A Culture of Success-Examining School Culture and Student Outcomes Via A Performance Framework. *Journal of Education and Learning*, 5(1), 114-127.
- Prokopchuk, J. (2016). Unpacking The Impact of School Culture: A Principal's Role in Creating and Sustaining The Culture of a School. *SELU Research Review Journal*, 1(2), 73-82.
- Purwoko, A. A., Andayani, Y., Muntar, & Diartha, I. N. (2017). Efforts in Improving Teachers' Competencies through Collaboration Between Teacher Forum on Subject Matter (MGMP) and Pre-Service Teacher Training Institution (LPTK). *Jurnal Pendidikan IPA Indonesia*, 6(1), 12-24.
- Richey, R. C., & Klein, J. D. (2007). *Design and Development Research*. (L. M. A. Akers, Ed.) (10th ed.). Mahwah, New Jersey: Lawrence Erlbaum Associates.
- Rodríguez, M. C., Vivas, J. R., Comesaña, A., Ramírez, L. M., & Peña, J. A. (2017). Perceived Social Support in Middle School Students. *International Review of Social Sciences*, 5(1), 81-90.
- Scileanna, A. (2015). *Advancing School Autonomy In The Irish School System*. Oideachais.
- Steiger, J. H. (2013). *Confirmatory Factor Analysis With R*. Psychology 312: Springer.
- Susilo, M. J. (2016). Kajian Kemandirian Sekolah di Amal Usaha Muhammadiyah. In *Prosiding Seminar Nasional Pendidikan Berkemajuan dan*

- Mengembangkan* (pp. 625–633). Medan: Kerjasama Asosiasi LPTK PTM, Majelis Diktilitbang PP Muhammadiyah, UMS, UMSU.
- Susilo, M. J. (2017a). Leadership Model in Muhammadiyah to Create Independence School. In *Proceedings of International Symposium on the Transition from School to Work* (pp. 125–131). Yogyakarta.
- Susilo, M. J. (2017b). *Pengembangan Model Evaluasi Kemandirian Sekolah Muhammadiyah di Kabupaten Sleman*. Yogyakarta State University.
- Sutarman, Tjahjono, H. K., & Hamami, T. (2017). The Implementation of Holistic Education in Muhammadiyah's Madrasah In Indonesia. *Dinamika Ilmu*, 17(2), 191–203.
- Theodorou, T. (2013). *Financial Management In The Cypriot Primary School of The Future: Decentralisation, Negative Effects And Support Measures [In Greek]*. Open University of Cyprus.
- Theodorou, T., & Pashiardis, P. (2016). Exploring Partial School Autonomy: What Does It Mean For The Cypriot School of the future? *Educational Management Administration & Leadership*, 44(1), 73–94.
- Troutman, L. D. (2012). *The Impact of Principal Leadership on School Culture and Student Achievement* (Doctoral dissertation, Wingate University).
- Vernez, G., Karam, R., & Marshall, J. H. (2012). *Implementation of School-Based Management in Indonesia. Monograph*. RAND Corporation. PO Box 2138, Santa Monica, CA 90407-2138.
- Weinstein, J., & Muñoz, G. (2014). When Duties are Not Enough: Principal Leadership and Public or Private School Management in Chile 1. *School Effectiveness and School Improvement*, 25(4), 651–670.
- Zaenuri, Sudarmin, Utomo, Y., & Juul, E. (2017). Habituation Model of Implementing Environmental Education In Elementary School. *Jurnal Pendidikan IPA Indonesia*, 6(2), 206–212.
- Zamroni. (2007). *Meningkatkan Mutu Sekolah: Teori, Strategi, dan Prosedur*. Jakarta: PSAP Muhammadiyah.
- Zamroni. (2016). *Kultur Sekolah*. Yogyakarta: Gavin Kalam Utama.



INCOMPLETE EXPLANATION IN DETERMINING OXIDATION NUMBER: A CASE STUDY ON CHEMISTRY PROGRAM STUDENTS

R. Basuki*¹, H. Amanda², R. Bemis³, A. Lisma⁴, Yusnaidar⁵

^{1,2}Department of Chemistry, Faculty of Science and Technology, Universitas Jambi

³Research Group of Material Engineering, Faculty of Science and Technology, Universitas Jambi

^{4,5}Instruments and Research Laboratory, Faculty of Science and Technology, Universitas Jambi

DOI: 10.15294/jpii.v7i3.13251

Accepted: February 2nd, 2018. Approved: August 31st, 2018. Published: September 20th, 2018

ABSTRACT

The term “oxidation number” and related concept such as “electronegativity” and “formal charge” appear frequently in both elementary and advance chemistry text. However, it is evident from the literature (or textbooks) that these terms are often viewed to be synonymous. Incomplete explanation of the fundamental concept of oxidation number can lead that conclusions pertaining to such a misleading interpretation. This research was conducted to review the concepts from common used high school chemistry textbooks and these concepts were then transformed to 6 number open minded problems. These problems were then tested to 40 first semester chemistry program students in the University of Jambi who joining Basic Chemistry course. The result was about 80% of students give the right answer in determining oxidation number (problem number 1). But, in the certain molecule (problem number 2) they can't determine correctly because they couldn't use the “Rule” from initial understanding in high school. For the next problem (4a), none of the students give the right oxidation number of an atom and all of them can't explain precisely correlation among oxidation number, electronegativity, and formal charge. The intent of this paper is to clarify the notion of oxidation number, electronegativity, and formal charge, describe their relationship (especially for high school chemistry textbooks), and criticize upon misleading application.

© 2018 Science Education Study Program FMIPA UNNES Semarang

Keywords: incomplete explanation, determining oxidation number, case study, chemistry program student

INTRODUCTION

In the history of chemistry, one of the most vehement disputes concerned the nature of oxidation (Weisberg, et al. 2011; Sunarya 2009; Utami et al, 2009). In 1718, Georg Stahl, a German chemist, studied the formation of metals from oxides by heating the oxide with charcoal (carbon). He proposed that the formation of metal was caused by a substance, called “phlogiston.” According to Stahl, the converse process of heating a metal in the air to form its oxide caused the release of phlogiston into the atmosphere (Sukopp, 2018). Fifty-four years later, the French chemist, Louis-

Bernard Guyton de Morveau performed careful experiments showing that, during combustion, metals increase in weight. However, the existence of phlogiston was so well established among chemists that he interpreted the results as meaning that phlogiston had the negative weight (Chang, 2010; Watoni, 2016). It was his colleague, Antoine Lavoisier, who was willing to throw out the phlogiston concept and propose that combustion was due to the addition of oxygen to the metal (oxidation) and the formation of a metal from an oxide correspondent to the loss oxygen (reduction) (Stadler & Harrowfielda, 2011; Sudarmo & Sariawati 2015). This concept was well-known as “redox” concept and the most ancient concept of redox.

*Correspondence Address
E-mail: rhmtbsq@gmail.com

Common used high school chemistry textbooks often attached development concept of redox from the ancient to the modern concept (Table 1). However, at the current time, both in elementary until advance level, the most concept has been used to explain the related concept in chemistry course is redox involved oxidation number (ON). From this concept, oxidation defines as increasing of ON, and reduction is decreasing of ON. Determining ON in high school first taught in grade X after they learn chemical bonding, atomic theory, and the periodic table of elements. Most of the commonly used chemistry text books using “the rules” approach to determine ON, without connection with the previous chapter (Österlund, et al. 2010; Permana, 2009). Besides, the fundamental concept of determining ON was much related to the previous concept.

Table 1. Redox Concept Definition from Ancient to the Modern Concept

Oxidation	Reduction
Gaining oxygen	Loosing oxygen
Loosing hydrogen	Gaining hydrogen
Loosing electron	Gaining electron
Increasing ON	Decreasing ON

Incomplete explanation of determining ON can result in misleading interpretations or misconception (Widarti et al, 2016; Harnanto & Ruminten 2009). Redox material misconception had been experienced by students (Rosenthal & Sanger, 2012; Al-Balushi et al, 2012; Setyawati, 2009) for example: they had a difficulty in distinguishing the definition of the oxygen and electrons transfer, they often experience an error in the determination of the oxidation number of atom in molecule, they did not know the key concept of oxidation and its relation to another concept i.e. electronegativity; and also they had a difficulty on how to apply the equalization to equalize the redox reactions. Misleading interpretation on determining ON will affect the students in the understanding and application of redox concept (Brandriet & Bretz, 2014; Muchtariadi, 2016; Purba 2015).

Determining ON matter in high school the first time studied in grade X after they learn chemical bonding, atomic theory, and the periodic table of element. Common high school chemistry textbook was using the “Rules” approach to determine ON. This “Rules” worked in some simple molecule, such as HCl, HNO₃, H₂SO₄, H₃PO₄, etc. But, for a more complex molecule or even simple organic molecule (ICl₃, CH₃COOH,

C₂H₅OH, Na₂S₂O₄, POBr₃, H₂O₂, etc.) the “Rules” didn’t work well. This phenomenon carried from high school to universities. In universities the chain of incomplete explanation of redox concept must be broken, especially through the Basic Chemistry Course. This paper aimed to give a better understanding of determining ON through complete explanation of the ON fundamental concept. Furthermore, the differences and their relation of ON concept with electronegativity, formal charge and the concept of valence were also critically discussed in this paper.

METHODS

This research employed the descriptive analysis study in the form of case study research. Forty students of Chemistry Program in the first semester (2017/2018) of University of Jambi were studied. They joined the Basic Chemistry course subject. The research instrument was an open answer test adapted from some commonly used chemistry textbook in Indonesia (Table 2). The textbook code A to E is an e-book published by Bookkeeping Center of the Ministry of National Education (Pusbuk) as Electronic School Book (ESB) which based on author’s experience it is still used as a learning source for High School students. The textbook F to I is a printed textbook which very easy to find because it was available in any bookstore in Indonesia.

Six open answers problems (Table 3) and the analysis of problem choice were given in the test before entering the Redox Reaction chapter (pre-test). The answer given by the students was a reflection of their thinking ability and their understanding of the concept learned before (in high school).

Table 2. Common Used Chemistry Textbooks as a Source of Instrument Research Problems

Code	Textbook Identity
A	Setyawati, A.A. (2009). Pusbuk ESB
B	Permana, I. (2009). Pusbuk ESB
C	Sunarya, Y & Setiabudi, A. (2009) Pusbuk ESB
D	Utami, D et al., (2009). Pusbuk ESB
E	Harnanto, A. & Ruminten. (2009). pusbuk ESB
F	Sudarmo, U. & Sariwati, E. (2015). Erlangga
G	Purba. M. (2015). Erlangga
H	Muchtariadi. (2016). Yudhistira
I	Watoni, H., Kurniawati, D., & Juniastri, M. (2016). Yrama Widya

RESULTS AND DISCUSSION

Determining the Oxidation Number

As stated before, common used high school chemistry textbooks use the "Rules" for determining ON. Here is a summary of these "Rules" from common used high school chemistry textbooks:

- (1) ON of free atom is zero;
- (2) Sum of ON in a neutral atom is zero;
- (3) ON of monoatomic ion is equal to its charge;
- (4) Sum of ON in a polyatomic ion is equal to its charge;
- (5) ON of oxygen atom generally is -2, but it is -1 in peroxide, and -1/2 in superoxide;
- (6) ON of hydrogen atom generally is +1, but it is +1 in hydride;

- (7) ON of another atom, determined from its group, such as group IA generally is +1, IIA is +2, IIIA is +3, VIIA generally is -1 etc.

It is mention in these textbooks some example of an atom in a molecule that the ON would be determined: "Determine the ON of S (sulfur) atom in H_2SO_4 !". Using rule number (2), (5), and (6), the calculation can be express:
 $(2 \times \text{ON of H}) + (1 \times \text{ON of S}) + (4 \times \text{ON of O}) = 0$
 $(2 \times +1) + (\text{ON of S}) + (4 \times -2) = 0$
 $(+2) + \text{ON of S} + (-8) = 0$
 ON of S = +6

The other example that can be solved using the "rules" were $KMnO_4$, $NaCl$, $K_2Cr_2O_7$, HNO_3 , H_3PO_4 , SO_3 , Fe_2O_3 , V_2O_5 , etc. (the underlined atom was atom will be determined its ON).

Table 3. The Problems Summary Adapted from Common Used High School Chemistry Textbooks

Num.	Problem	Analysis
1	Determine the oxidation number of each atom in the molecule below! a. HNO_3 H : N : O : b. Fe_2O_3 Fe : O : c. $KMnO_4$ K : Mn : O : d. $K_2Cr_2O_7$ K : Cr : O :	C3 Level. ON of each atom of this molecule can be easily determined by "The Rules".
2	Determine the oxidation number of each atom in the molecule below! a. KO_2 K : O : b. NaH Na : H : c. H_2O_2 H : O : d. OF_2 O : F :	C3 Level. "The Rules" still partly applied, but the student starts to confuse especially to determine the sign (+) or (-).
3	Based on what theory you choose each oxidation number in problem number 2?	C4 Level. The students should explain based on what thy choose (+) or (-) sign in ON.
4	Determine the oxidation number of each atom in the molecule below! a. $S_3O_2^{2-}$ S : O : b. $POBr_3$ P : O : Br : c. CH_3COOH C : H : O : d. ICl_5 I : Cl :	C4 Level. "The Rules" completely can't be used. ON determined by Lewis structure interpretation and electronegativity concept.
5	Based on what theory you choose each oxidation number in problem number 4?	C4 Level. The students should explain based on what thy choose (+) or (-) sign in ON.
6	Determine the formal charge for each atom in problem number 4! Can you explain the nature of formal charge compares with oxidation number? S : O : P : O : Br : C : H : O : I : Cl :	C4 Level. Formal Charge is "ownership" of an electron if shared evenly. In high school FC has almost never been introduced.

The results of problem 1 appear in Figure 1. These results indicated the good understanding of some molecule that its ON can be solved by the "Rules". The wrong answers were caused by mistake assumption that ON belongs to a group of the atom. The right concept was ON belongs to only a single atom. The percentage of the right answers to problem 1 can be seen in Figure 1.

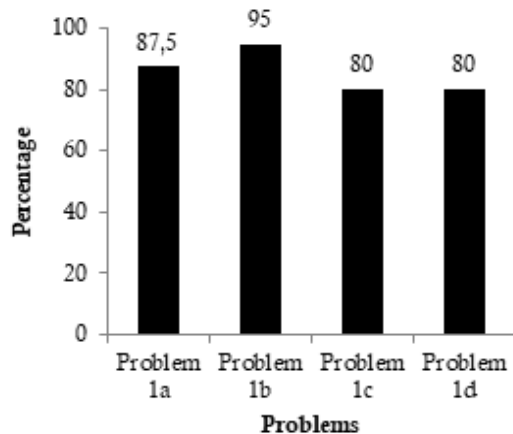


Figure 1. The Right Answers Percentage of Problem 1

Overall, the right answers percentage above 80%, so problem 1 successfully solved using "The Rules".

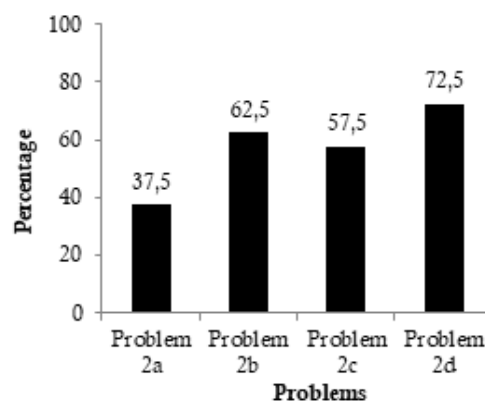


Figure 2. The Right Answers Percentage of Problem 2

The Correlation of ON, Chemical Bonding, and Electronegativity

The problems emerged when the students try to solve Problem 2. They were confused determined ON of each atom especially its sign, (+) or (-). Even tough, almost 50% give the right answers, but them just guessing. They haven't a fundamental concept to confirm their results. This proven by them that they can't answer Problem 3. Some students answer "Exceptional", but still, they didn't know for sure when using "exceptional" and "common" one.

Table 4. Electronegativity of Pauling Scale Several Selected Atoms (Mann, et al. 2000)

1	2	12	13	14	15	16	17	18
H 2.300								He 4.160
Li 0.912	Be 1.576		B 2.051	C 2.554	N 3.066	O 3.610	F 4.193	Ne 4.787
Na 0.869	Mg 1.293		Al 1.613	Si 1.916	P 2.253	S 2.589	Cl 2.689	Ar 3.242
K 0.734	Ca 1.034	Zn 1.588	Ga 1.756	Ge 1.994	As 2.211	Se 2.424	Br 2.685	Kr 2.966
Rb 0.706	Sr 0.963	Cd 1.521	In 1.656	Sn 1.824	Sb 1.984	Te 2.158	I 2.359	Xe 2.582
Cs 0.659	Ba 0.881	Hg 1.765	Tl 1.789	Pb 1.854	Bi (2.01)	Po (2.19)	At (2.39)	Rn (2.60)

Problem 2 shows us that ON is very related to another concept. The concepts that so related with ON were electronegativity and chemical bonding. The definition by its terminology of ON is the charge remaining on an atom when all ligands are removed heterolytically in their closed form, with the electron being transferred to the more electronegative partners; homonuclear bonds do not contribute to the ON (Parkin, G., 2006). Table 4. shows the value of electronegativity by Pauling scale on several selected atom (Jensen, 2012; Chattaraj & Duley, 2010).

From the explanation of redox definition above, it can conclude two things; first, ON can be determined from differences between electronegativity values. It was because the differences in electronegativity values lead to the type of chemical bonds. If the differences were great, the substance tends to ionic, otherwise if slight, it tends to covalent. The level of ionic character can be determined by calculation of moment dipole (Miessler et. al., 2014) and covalent character can be determined by Fajans Rule i.e. calculation of charge density/polarization of molecule (Can-

ham & Overton, 2010). Based on both methods, there is no molecule with 100% of ionic/covalent character. The term ionic/covalent compound means it has greater ionic/covalent, not pure ionic/covalent compound (Wells, 2012; Diercks & Yaghi, 2017).

The second, ON concept is designated for a substance that has wide electronegative differences, thus, the substance assumed tend to ionic. These electronegative differences cause the heterolytic cleavage, where the electron will give to the atom with greater electronegativity. If the atom in substance has the same electronegativity, so the substance tends to covalent and cause the homolytic cleavage, where the electron will be share equally to each atom/ligands. This condition obtains a new unit called a formal charge (FC). The calculation of ON and FC can be seen below (Figure 3).

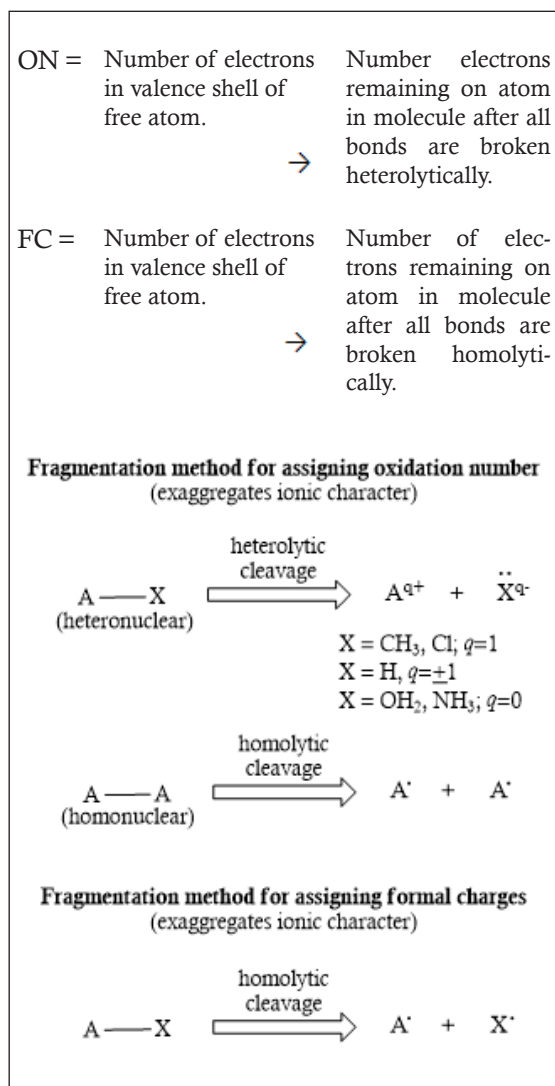


Figure 3. Fragmentation Methods for Assigning the Oxidation Number and the Formal Charge.

Determining ON based on this concept requires drawing the Lewis structure (electron-dot) that molecule. Whereas, an electron in covalent polar bond is not fully shared together, to simplify the ON calculation it is assumed that electron “belong to” atom with greater electronegativity. Example of determining some common compound can be seen in Figure 4.

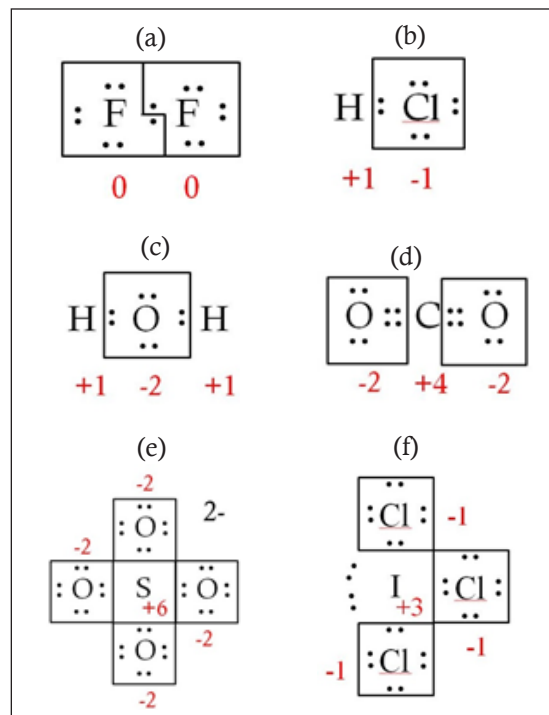


Figure 4. Determining ON of Some Common Compounds by Heterolytic Cleavage

Figure 4(a) explains why the free molecule has ON zero. Fluorine atom in the F_2 molecule has the same electronegativity, so will be a homolytic cleavage, where electron shared equally. So, ON of both F atom can be count as $7 - 7 = 0$. The same principle can be applied to Figure 4 (b) to (f) that electron as if “belong to” the more electronegative atom. Then, the right answer of problem number 3 and 5 was “electronegativity”. Only 15% (6 students) give the right answer, the rest of them reply with “because of the rule” answers.

From the explanation presented in Figure 4, we can determine ON compound in problem 4 correctly (Figure 5). The bond symbolized by line (–) means the pairs of the electron. The right answers percentage of Problem 4 shows in Figure 6. The entire students think that ON of sulfur atom in $\text{S}_2\text{O}_3^{2-}$ ion (Figure 5a) has the same value, +2. Using “The Rules” they count $2 \times (\text{ON S}) + 2 \times (-2) = -2$. This calculation can’t be accepted because each of sulfur has a different environment.

ON of S (center) has only 1 electron left because it is bonding with 3 oxygen atoms which have a higher electronegativity than S and 1 S atom which have equal electronegativity. So, calculation can be written $ON\ S\ (\text{center}) = 6 - 1 = +5$, for S (side) $ON = 6 - 7 = -1$. Calculation of FC (Problem 6) cannot be answered correctly by all students. The FC sound so strange in students because FC concept was not introduced in high school (Loock, 2010). All students confirm that there is no explanation about FC in the previous place (high school or university). In high school (or university) FC can be taught related to VSEPR topics (Taber, 2013).

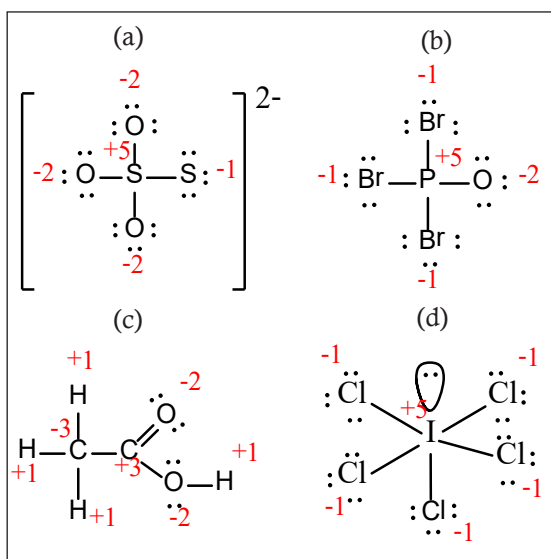


Figure 5. The ON of an Atom in the Molecule at Problem 4

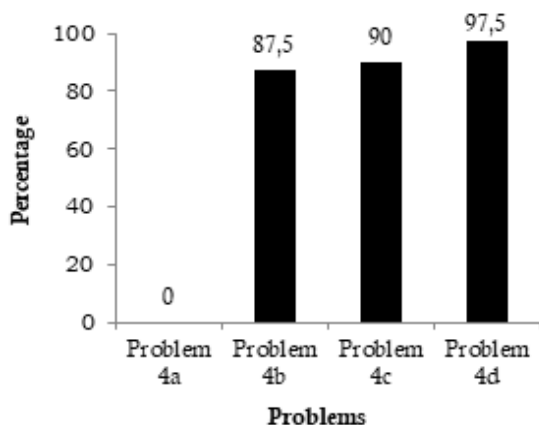
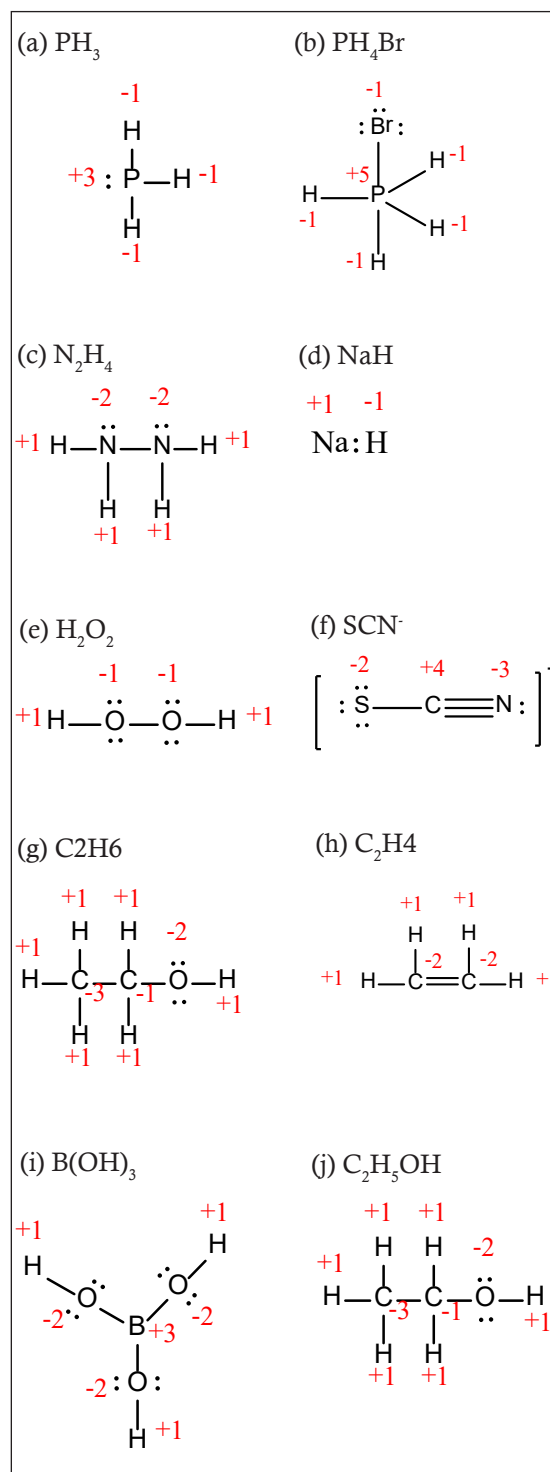


Figure 6. Right Answers Percentage of Problem 4

Memorizing “The Rules” for determining ON was not so helpful if the deal with the more complex compound. Some compound only can be determined the ON by the combination of Le-

wis structure and electronegativity. Using “the rules” to determine ON of complex compound can lead to mistake knowledge and misconception (Regan et al, 2011). From 9 common high school chemistry textbooks (Table 2), only 2 books provide the information of electronegativity to determine ON. However there was still had some mistakes in the example. Here is some common compound in some textbook which often mistakes in determining of ON (Figure 7).



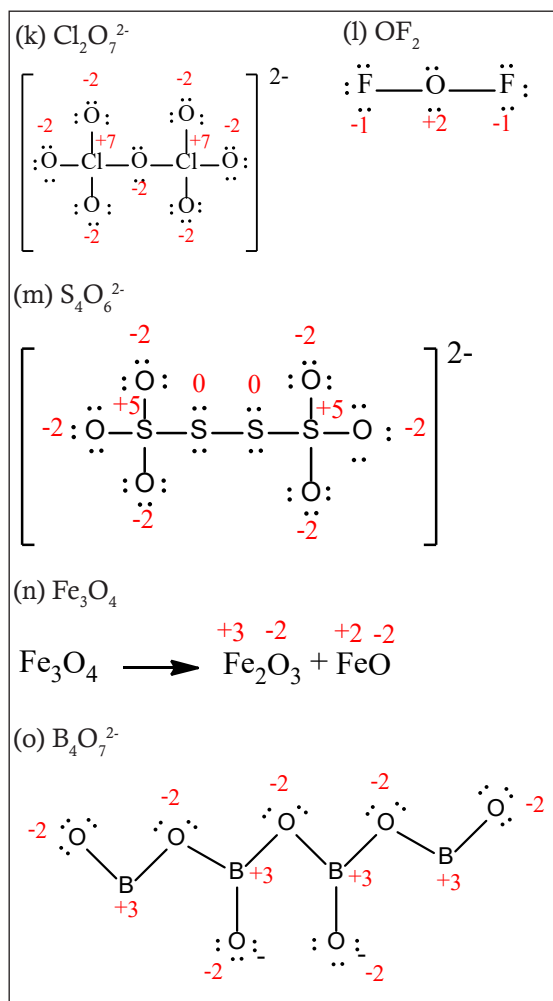


Figure 7. The Common Compound which often Mistakes in Determining the ON

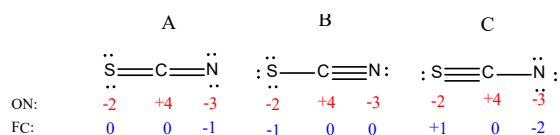


Figure 8. ON and FC of Thiocyanate Ion Resonance

The difference of the fundamental approach between ON and FC has important consequences: ON is independent; it is not depending on molecular structure (Lewis Structure). But, FC is changed depending from its Lewis structure. The Example of this phenomenon can be seen in thiocyanate ion resonance (Figure 8).

CONCLUSION

ON is an important concept in both elementary and advance chemistry. Learning ON in high school or in the beginning year in the uni-

versity should be taught by the related concept: electronegativity and Lewis structure. This case study research concludes that the most of the students only know "The Rules" as initial knowledge from High School to determining oxidation number. These leads most of the students can solve Problem No. 1 and No. 2 which was simple molecules that can be solved using "The Rules". For the next problem (No.3 – No.6), less than 10% students give the correct oxidation number of an atom and none of them can explain precisely correlation among oxidation number, electronegativity, and formal charge. Learning ON in High School (or in the beginning year in university) should be taught by the related concept: electronegativity and Lewis structure supported by chemistry text book containing complete related concept. Without learning these connection concepts, misconceptions tend to occur and the student will struggle to learn chemistry.

ACKNOWLEDGEMENTS

The author(s) thanks Prof. Sutrisno, Ph.D as former dean of the Faculty of Science and Technology, Universitas Jambi for facilitating this work.

REFERENCES

- Al-Balushi, S. M., Ambusaidi, A. K., Al-Shuaili, A. H., & Taylor, N. (2012). Omani Twelfth Grade Students' Most Common Misconceptions In Chemistry. *Science Education International*, 23(3), 221-240.
- Brandriet, A. R., & Bretz, S. L. (2014). The Development of the Redox Concept Inventory as a Measure of Students' Symbolic and Particulate Redox Understandings And Confidence. *Journal of Chemical Education*, 91(8), 1132-1144.
- Canham, J.R., & Overton, T. (2010). *Descriptive Inorganic Chemistry Fifth Edition*. New York, NY: W. H. Freeman and Company.
- Chang, H. (2010). The Hidden History of Phlogiston. *HYLE-International journal for philosophy of chemistry*, 16(2), 47-79.
- Chattaraj, P. K., & Duley, S. (2010). Electron Affinity, Electronegativity, and Electrophilicity of Atoms and Ions. *Journal of Chemical & Engineering Data*, 55(5), 1882-1886.
- Diercks, C. S., & Yaghi, O. M. (2017). The Atom, the Molecule, and the Covalent Organic Framework. *Science*, 355(6328), eaal1585.
- Harnanto, A., & Ruminten. (2009). *Chemistry 1: for SMA/MA grade X*. Jakarta: Bookkeeping Center of the Ministry of National Education.
- Jensen, W. B. (2012). When Was Electronegativity First Quantified? II. *Journal of Chemical Education*, 89, 94-96.

- Loock, H. P. (2010). Expanded Definition of the Oxidation State. *Journal of Chemical Education*, 88(3), 282-283.
- Miessler, G.L., Fischer, P.J., & Tarr, D.A. (2014). *Inorganic Chemistry Fifth Edition*. New York: Pearson Education, Inc.
- Muchtariadi. (2016). Kimia 1 SMA Kelas X (edisi revisi 2016). Jakarta: Yudhistira.
- Österlund, L. L., Berg, A., & Ekborg, M. (2010). Redox Models in Chemistry Textbooks for the Upper Secondary School: Friend or Foe?. *Chemistry Education Research and Practice*, 11(3), 182-192.
- Parkin, G. (2006). Valence, Oxidation Number, and Formal Charge: Three Related but Fundamentally Different Concepts. *Journal of chemical education*, 83(5), 791.
- Permana, I. (2009). *Understanding Chemistry 1: SMA/MA for grade X 1st and 2nd semesters*. Jakarta: Bookkeeping Center of the Ministry of National Education.
- Purba, M., (2015). *Chemistry 1: for SMA/MA Grade X (Specialization Group of Mathematics and Natural Sciences) K2013*. Jakarta: Erlangga.
- Regan, Á., Childs, P., & Hayes, S. (2011). The Use of an Intervention Programme to Improve Undergraduate Students' Chemical Knowledge and Address their Misconceptions. *Chemistry Education Research and Practice*, 12(2), 219-227.
- Rosenthal, D. P., & Sanger, M. J. (2012). Student Misinterpretations and Misconceptions Based on Their Explanations of Two Computer Animations of Varying Complexity Depicting the Same Oxidation-Reduction Reaction. *Chemistry Education Research and Practice*, 13(4), 471-483.
- Schweitzer, B., & Sukopp, T. (2018). *Knowledge Communities in Europe: Discoveries of Oxygen and the "Chemical Revolution" in the Context of European Scientific Networks*. In *Knowledge Communities in Europe* (pp. 15-47). Springer VS, Wiesbaden.
- Setyawati, A.A. (2009). *Chemistry studies Natural Phenomena for Grade X SMA/MA*. Jakarta: Bookkeeping Center of the Ministry of National Education.
- Stadler, A. M., & Harrowfield, J. (2011). Places and Chemistry: Strasbourg—A Chemical Crucible Seen through Historical Personalities. *Chemical society reviews*, 40(5), 2061-2108.
- Sudarmo, U., & Sariwati, E., (2015). *Students Book: Chemistry for SMA/MA Grade X (Specialization Group of Mathematics and Natural Sciences) K2013*. Jakarta: Erlangga.
- Sunarya, Y. (2009). *Easy and Active Learning Chemistry 1: for grade X SMA/MA*. Jakarta: Bookkeeping Center of the Ministry of National Education.
- Taber, K. S. (2013). Revisiting the Chemistry Triplet: Drawing upon the Nature of Chemical Knowledge and the Psychology of Learning to Inform Chemistry Education. *Chemistry Education Research and Practice*, 14(2), 156-168.
- Utami, B., Saputro, A.N.C., Mahardiani, L., Yamtinah, S., & Mulyani, B. (2009). *Chemistry 1: for SMA/MA grade X*. Jakarta: Bookkeeping Center of the Ministry of National Education.
- Watoni, H., Kurniawati, D., dan Juniastri, M. (2016). *Chemistry for SMA/MA Grade X Specialization Group of Mathematics and Natural Sciences*. Bandung: Yrama Widya.
- Wells, A. F. (2012). *Structural Inorganic Chemistry*. Oxford University Press.
- Widarti, H. R., Permanasari, A., & Mulyani, S. (2016). Student Misconception on Redox Titration (A Challenge on the Course Implementation through Cognitive Dissonance based on the Multiple Representations). *Jurnal Pendidikan IPA Indonesia*, 5(1), 56-62.
- Weisberg, M., Needham, P., & Hendry, R. (2011). Philosophy of chemistry.

**THE DEVELOPMENT AND TEACHERS' PERCEPTION ON ELECTROMAGNET TEACHING AID: MAGNOBOLT****A. M. Sharif*¹, M. N. A. Azman², B. Balakrishnan³, M. I. H. Yaacob⁴,
H. H. M. Zain⁵**^{1,4,5}Faculty of Science and Mathematics, Universiti Pendidikan Sultan Idris, Malaysia²Faculty of Technical and Vocational, Universiti Pendidikan Sultan Idris, Malaysia³Faculty of Art, Computing and Creative Industry, Universiti Pendidikan Sultan Idris, Malaysia**DOI: 10.15294/jpii.v7i3.13491**Accepted: February 21st, 2018. Approved: August 31st, 2018. Published: September 20th, 2018**ABSTRACT**

Magnobolt is a teaching aid built on hands-on activity and exercises. This study examined a framework that could integrate both theoretical and practical of learning science in Malaysia. ADDIE model was used for Magnobolt module development. The perception of 300 science teachers across the Perak on Magnobolt studied via questionnaire includes two parts; Pedagogical Approach to Teaching and Learning and training suitability. The reliability for Magnobolt was tested on a total of 30 teachers which were not involved in the actual study. An analysis of the Cronbach's Alpha exhibits 0.945 showed very good reliability. Three content domain experts were involved to evaluate the validity of the Magnobolt. A real case study on 300 science teachers agreed that the Magnobolt was developed for a pedagogical approach to teaching and learning and suitable for training with the total mean score of 4.34 and 4.25 respectively. This science module also injects the element of creativity and innovation to build fun in learning science and creative capacity of teachers.

© 2018 Science Education Study Program FMIPA UNNES Semarang

Keywords: electromagnet, soft skill, teaching aid, STEM education

INTRODUCTION

Science education is important in developing generation which has creative, critical and innovative thinking. In Malaysia, the aim is to have the ratio of students taking Science compare to Art is 60:40 (Phang et al., 2014; Kementerian Pendidikan Malaysia, 2012). Unfortunately, the number of students who took the Malaysian Certificate of Education Examination; Sijil Pelajaran Malaysia (SPM) examination in Science course in 2016 was only 90,000, far less than the 270,000 required each

year (Bernama, 2016). In 2017, the ratio students pursue their study in Science compare to Art is 20:80 (Bernama, 2017).

The lack of students' participation in the field of Science at both secondary school (age 11 to 17 or from 1 to 5) and university levels become a concern for all parties. Nordin & Lin (2011) in their research found that there was a weak significant positive relationship between the attitude towards Science and mastery level of Science's basic concepts. Other previous research which investigates aspects that were closely related to motivation such as student interest (Bryan et al., 2011), student attitudes (Kususanto et al., 2012), students' engagement

***Correspondence Address**

E-mail: aisyah@fsmt.upsi.edu.my

(Sinatra et al., 2008), student enrollment in Science courses (Bøe, 2012) and self-confidence (self-efficacy) (Glynn et al., 2011; Britner, 2008) found that students' attitudes, interests and motivation towards science learning declining after learning this subject especially while in secondary school.

One of the science topics which become a challenge for students to understand and develop the self-concept in understanding its fundamental is electromagnet (Rohadi, 2016). The electromagnet is a temporary magnet generated by the electromagnetism, which is the effect of an electric current flowing through a conductor example an electric wire (Baharoom & Samar, 2016; Nicolaide, 2012). The magnetic field is only produced when the current flow through the conductor and the magnetic field will disappear when there is no current flow through the conductor.

In Malaysia, learning on electromagnet is introduced in the syllabus of science subject for form 3 students (age 15). It is covered under topic 1.9 Understanding of Electromagnetism (Kementerian Pendidikan Malaysia, 2011). In this topic, students learn theoretically on fundamental of electromagnetism concept, the factor of electromagnet's strength and diagram of the electromagnet circuit.

This learning technique is known as a hard skill technique (Fakhriyah, 2014). Hard skill helps students master textbook materials. It does not help students in the form of critical thinking and problem-solving which known as soft skill technique (Wagner, 2008). In Science, students need both to understand the concept and how it can be applied in real life. Ministry of Education (MOE) has introduced STEM (Science, Technology, Engineering, and Mathematics) module in school (Adnan et al., 2017; Zainudin et al. 2016). STEM encourage the development of student interest in Science, Technology, Engineering, and Mathematics. STEM module is a Project-based Inquiry Learning (PIP) approach. There are four learning phases in this method which are; Inquiry phase, Exploration phase, Design and Experiments phase, and Reflection phases (Adnan et al., 2017).

Therefore, in order to enhance understanding of the electromagnet for form 3 students, the main objective of this research is to introduce a teaching aid to help students to understand the concept of the electromagnet. This module suite the STEM module and will help to develop the soft skill of their learning

technique in identify, analyze and logical thinking to have a better understanding on the concept that they learn through hard skill.

METHODS

Magnobolt was prepared using the AD-DIE model which are Analyze, Design, Develop, Implement and Evaluation (Jones, 2014). The research was performed at Perak, Malaysia. Magnobolt consists of an educational kit and a module.

Analyze

It started by analyzing the previous studies on finding the reason which causes students unable to understand the concept of electromagnet correctly. It was found that there are 4 problems that students are facing generally. They were misconceptions, insufficient understanding of science, weak in mastery the knowledge of science and difficult to build and master science conception (Drieberg & Sahoo, 2013).

This problem occurs because there is no practical approach in the syllabus that can enhance the students' understanding through experience it through hands-on activity. In the end, students only memorized the concept and its factors in for the sake of examination.

Design

The design of the Magnobolt was taking the feature from the practical experiment of electromagnetism topic in form 5 (age 17) but simplified according to the syllabus in form 3 (age 15) (Kementerian Pendidikan Malaysia, 2013). It also took STEM module as a reference to design the module.

Furthermore, this teaching aids was designed with the following criteria: (1) User-friendly; (2) Cost-effective; (3) Laboratory free; and (4) Be able to use it anywhere

Development

This teaching aid named Magnobolt which consist of different size of the bolt, multicolored wire, battery holder, paper clips and plastic holder. Comparing to the existing activities that have been taught for form 5 students (see Figure 1), the iron nail is normally used as the core of the solenoid to produce electromagnet, but the resulting electromagnetic force is relatively weak and the factors that influence the electromagnetic force cannot be manipulated and proven.

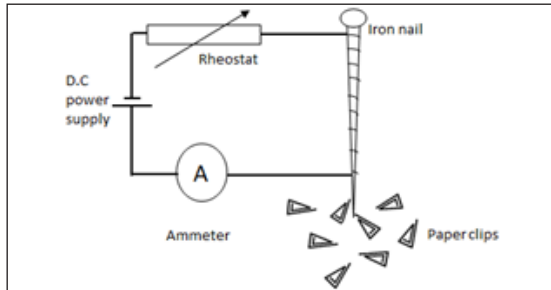


Figure 1. Experiment Diagram of Electromagnetism in Form 5

Therefore, Magnobolt introduces the use of construction bolt as the core. Similarly, students are required to coil conducting wires to the bolt and complete the connection to the battery to make solenoid and producing electromagnet (refer Figure 2). The electromagnet is then bringing near to paper clips as shown in Figure 3 and the numbers of paper clips attracted are recorded. Through this activity, students are exploring to the factors that affect the strength of the electromagnet by varying the number of coils, the diameter of the core, type of core and the amount of current which synchronize to their syllabus in form 3. Thus, students will be able to manipulate these factors and to think creatively about how these factors affect the strength of the electromagnet.

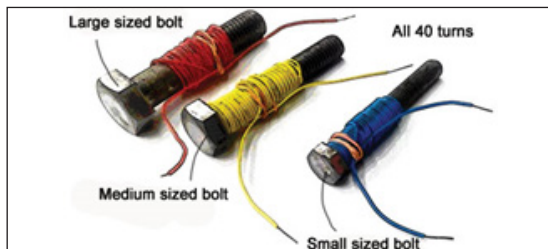


Figure 2. Wires are Coiled onto Bolts of Different Size

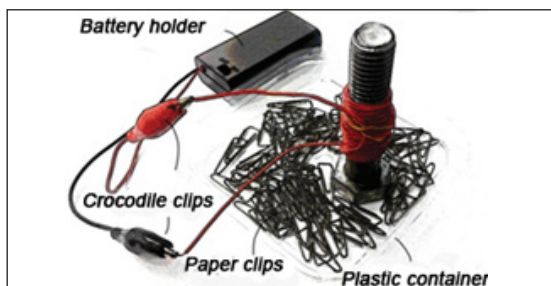


Figure 3. Circuit of Magnobolt to Test Electromagnet by Amount of Paper Clips Attracted to Bolt Head.

This teaching aid is also equipped with a module to guide students based on the STEM module.



Figure 4. Module of Magnobolt

In this module, students were given the basic introduction of the electromagnet. Before starting the experiment, the students went through the objectives that they would achieve at the end of the experiment. These objectives were the Inquiry phase in STEM module.

Exploration phase was when the students acquired to familiarize with the tools to be used in the experiment. Furthermore, the students explored through the experiment's instruction and organize themselves for the experiment. After that, students will design the circuit according to the instruction given and modify it to perform the different test for the experiment. This is called Design and Experiments phase. Reflection phase was when the result that students gain for each experiment would be recorded in a table form (Figure 5). The students discussed in their group for the outcome based on the objectives in the Inquiry phase. Besides, in this module, there were 8 reflection questions to evaluate students understanding of the topic.

HASIL DAPATAN

Jadual 2.1

Soliz bolt	Jumlah klip kertas ditarik
Besar (Solenoid merah)	
Sederhana (Solenoid kuning)	
Kecil (Solenoid biru)	

Jadual 2.2

Bilangan lilitan	Jumlah klip kertas ditarik
60 (Solenoid merah)	
40 (Solenoid biru)	
20 (Solenoid kuning)	

Jadual 2.3

Voltan bateri (V)	Jumlah klip kertas ditarik
1.5 (Satu bateri)	
3.0 (Dua bateri)	[Gunakan nilai berdasarkan Jadual 2.2]

*Nota = Perbandingan dilakukan ke atas bilangan lilitan yang sama

MY Teachers Try Science 24

Figure 5. Table of Results

Implementation

A pilot study was run towards 30 science expert teachers were chosen with the help of Perak State Education Department (JPN Perak) to evaluate the reliability of Magnobolt. The purpose of the pilot study was to establish the psychometric properties of the research instrument. The pilot test also served to determine whether respondents could follow directions, and could interpret and understand the questionnaire items. In addition, piloting the questionnaire established whether the instrument was suitable for generating measurable data before utilizing the instrument for data collection of validity.

The Magnobolt Evaluation Questionnaire was developed for teachers to evaluate the modules. The instrument has two sections: (1) Section A, Respondent demography and (2) Section B, Module questionnaire. Section B was further divided into two parts: (1) Pedagogical approach to teaching and learning and (2) Training suitability. Each part had 8 items. The responses were measured on a 5 Likert Scale: (1) Most Disagree; (2) Disagree; (3) Uncertain; (4) Agree; and (5) Most Agree

Each of the expert teachers trained 10 science teachers in a two-day training course using experimental and project-based learning. Selection of the 300 teachers was also aided by JPN Perak. The science teachers' lesson plans were monitored by attendance sheets, pictures, and their recording videos. The questionnaire data collected and the results discussed in the results and discussion section.

Evaluation

There were two processes of evaluation. The first process is validation from content domain experts. Magnobolt was validated by 3 expert lecturers in Universiti Pendidikan Sultan Idris (UPSI).

The second process of evaluation was reliability. A reliability index is a degree to which a test consistently measures whatever it claims to be measuring (Gay & Airasian, 2003). Reliability of an instrument is typically judged by the instrument's stability over time and context as well as internal consistency. Reliability demonstrates how well the instrument measure what it purports to measure.

The guideline provided by DeVellis (2012) was used to check the reliability of the items in the instrument used are below 0.60 (unacceptable), between 0.60 and 0.65 (undesirable), between 0.65 and 0.70 (minimally acceptable), between

0.70 and 0.80 (respectable), between 0.80 and 0.90 (very good) and for values above 0.90, one should consider shortening the scale.

The standard reliability coefficient of 0.70 is usually associated with instrument reliability (Gay, 1996) and was adopted as the benchmark for the instrument used in this study. The reliability of the questionnaire was tested on a total of 30 teachers which were not involved in the actual study. An analysis on the Cronbach's Alpha coefficient was generated using the SPSS software package. The instrument had reliability at 0.945 which considered 'very good' based on the DeVellis (2012) guideline. This instrument was later used on the bigger population of 300 teachers selected as the sample for the study.

RESULTS AND DISCUSSION

The analysis of the questionnaire was done on each item of the questionnaire. A total of 300 teachers responded to the questionnaires. Each item's analysis is presented in Table 1 and Table 2.

Analysis of the Magnobolt Teaching Module

The Table 1 shows the analysis outputs for each of the eight items in the pedagogical approach for teaching and learning the Magnobolt module.

Table 1. Items in the Pedagogical Approach for Teaching and Learning

No.	Item	Mean Score
1	Suitability of content	4.38
2	Suitable for the given topic	4.40
3	Reflective questions are of diverse cognitive levels	4.22
4	Reflective questions encourage creative thinking	4.29
5	Questions were based on the learning standard for KSSM	4.27
6	Problem solving skill	4.30
7	Test on conceptual understanding	4.38
8	Increase student's motivation	4.47
	Total	4.34

Analyses of the pedagogical approach for teaching and learning of the Magnobolt module showed the mean score for the 8 items were more than Likert scale 4. All responses were skewed to the right suggesting that all respondents 'agree' or 'most agree' that the pedagogical approach for teaching and learning of the module is appropriate for the teaching of the topic of electromagnetism. The highest scoring item was Item 8 with a higher overall mean score of 4.47. This finding indicated that the activities prepared in this module motivated the students to learn the topic of electromagnetism. The motivational aspect of Science learning is crucial to building learning interest of students to involve further in exploring the subject (Vedder-Weiss & Fortus, 2012; Bawaneh et al., 2011).

Item 1 and Item 2 provided the mean score of 4.38 and 4.40 respectively indicating that the respondents agreed on the contents and topics of the module that coincided with the subject of science form 3. The Item 1 and Item 2 were supported by Item 5 with the mean score of 4.27. This item agreed that the questions in the module were based on the learning standard for the students' learning syllabus in school. On overall conceptual understanding on the module (Item 7) showed that respondents agreed with the mean score of 4.38. Thus, this module has proven reliable as teaching aids in helping the students to understand the electromagnet concept.

Item 3 and Item 4 were related to reflective questions provided in the module with the mean score of 4.22 and 4.29 respectively. The reflective questions comprising diverse cognitive level which constructed from C1 to C4 in line with the level of science in form 3. The specification of from 3 science curriculum illustrated that the student learning outcome was to understand the concept of electromagnetism and able to explain the electrical current flowing through the conductor with magnetism (Kementerian Pendidikan Malaysia, 2011). According to Bloom's Taxonomy, every level has different complexity and specificity started from Remember (C1), Understanding (C2), Apply (C3), Analyze (C4), Evaluate (C5) and Create (C6) (Anderson & Krathwohl, 2001). Respondents also agreed with reflective questions in the module to encourage creative thinking. For example, "why different turns of wires attract the different amount of paper clips?" This question encouraged the students to relate the amount of wire turns to the resulting magnetic strength and interpret the magnetic force through the amount of paper clip that has been successfully pulled.

Questions in Magnobolt module were designed to encourage creative thinking. Creative thinking helps to enhance the problem-solving skill among students (Awang & Ramly, 2008). This was agreed by the respondents with the mean score of item 6 problem-solving skill; 4.30.

Table 2 shows the analysis outputs for each of the eight items in the suitability for training of the Magnobolt module.

Table 2. Mean Score for Each of the Eight Items in the Suitability for Training

No.	Item	Mean Score
1	Brief instructions	4.26
2	Clear instructions	4.26
3	Clear illustrations	4.30
4	Precise illustration	4.27
5	Suitable font size	4.20
6	Suitable font type	4.30
7	Correct use of language	4.27
8	Applicable duration time of activity	4.16
	Total	4.25

Moving on to the suitability for the training of the Magnobolt module, the responses were also skewed to the right suggesting that all respondents 'agree' or 'most agree' that the suitability for the training of the module was appropriate for the teaching of the topic of electromagnetism. The Magnobolt module showed the mean score for the 8 items was more than Likert scale 4. Two items had the highest overall mean score. These items were Item 3 and Item 6 with a mean score of 4.30.

The Magnobolt using clear and precise illustration (Figure 2 and 3) for students to understand the tools that they used and how they could perform the experiment. Font type Tw Cen Mt and size font 14 used in this module were agreed by the respondents suitable for training dimension with mean score 4.30 and 4.20. Font type Tw Cen MT has a writing character similar to the way student is writing at school. Especially on the small letter of "a" and "g". In school, the students were practiced to write that small letter like "a" and "g". Familiar writing style helped to reduce challenges for students to read. Using bigger font size did help the students to improve their reading comprehension by able to see the

words clearly, distinctive and enhance attention which eased for the readers to remember the words (Mueller et al., 2014).

CONCLUSION

The developed Magnobolt teaching aid enabled the teachers and students to integrate both theoretical and practical elements in science teaching as well as enhanced the students' interest towards STEM subject. Since the materials of the experiment could be easily obtained, it can be used to illustrate the concept of electromagnetism to the students. The feedback from the teachers reflected this module may help in their teaching and generate ideas for them to develop other teaching aids in order to make science teaching and learning more fun in schools.

ACKNOWLEDGEMENTS

This research has been supported via MY Teachers Try Science IBM Malaysia Grant Scheme (Research code: 2015-0189-107-33).

REFERENCES

- Adnan, M., Ayob, A., Tek, O. E., Ibrahim, M. N., Ishak, N., & Sheriff, J. (2017). Memperkasa Pembangunan Modal Insan Malaysia di Peringkat Kanak-kanak: Kajian Kebolehlaksanaan dan Kebolehintegrasian Pendidikan STEM dalam Kurikulum PERMATA Negara (Enhancing Malaysian Human Capital from Early Childhood: A Study in The Feasibility and Integrability of the STEM System in The PERMATA Negara curriculum). *Geografia-Malaysian Journal of Society and Space*, 12(1), 29-36.
- Anderson, L. W., & Krathwohl, D. R. (2001). *A Taxonomy for Learning, Teaching, and Assessing: A Revision of Bloom's Taxonomy of Educational Objectives*. Complete ed. New York: Longman.
- Awang, H., & Ramly, I. (2008). Creative Thinking Skill Approach Through Problem-based Learning: Pedagogy and Practice in The Engineering Classroom. *International Journal of Human and Social Sciences*, 3(1), 18-23.
- Baharoom, S. & Samar, N. (2016) *Arts & Stability Card Dan Magnobolt*. Perak: Universiti Pendidikan Sultan Idris.
- Bawaneh, A. K. A., Zain, A. N. M., Salleh, S., & Abdullah, A. G. K. (2012). Using Herrmann Whole Brain Teaching Method to Enhance Students' Motivation Towards Science Learning. *Journal of Turkish Science Education*, 9(3), 3-22.
- Bernamea (2016, November 5) Malaysia Berdepan Kekurangan Pelajar Aliran Sains yang Serius. *Astro Awani*. Retrieved from <http://www.astroawani.com>.
- Bernamea (2017, September 23) Pelajar Ambil Bidang STEM Semakin Berkurangan. *Malaysia Kini*. Retrieved from <https://www.malaysiakini.com>.
- Bøe, M. V. (2012). Science Choices in Norwegian Upper Secondary School: What Matters?. *Science Education*, 96(1), 1–20.
- Britner, S. L. (2008). Motivation in High School Science Students: A Comparison of Gender Differences in Life, Physical, and Earth Science Classes. *Journal of Research in Science Teaching*, 45(8), 955–970.
- Bryan, R. R., Glynn, S. M., & Kittleson, J. M. (2011). Motivation, Achievement, and Advanced Placement Intent of High School Students Learning Science. *Science Education*, 95(6), 1049–1065.
- DeVellis, R. F. (2012). *Scale Development: Theory and Applications* (3rd ed.) Thousand Oaks, CA: Sage Publications.
- Drieberg, M., & Sahoo, N. C. (2013). On Resonance and Frequency Response Characteristics of Electrical Circuits. *International Journal of Electrical Engineering Education*, 50(4), 368-383.
- Fakhriyah, F. (2014). Penerapan Problem Based Learning dalam Upaya Mengembangkan Kemampuan Berpikir Kritis Mahasiswa. *Jurnal Pendidikan IPA Indonesia*, 3(1), 95-101.
- Gay, L. R. & Airasian, P. (2000). *Educational Research Competencies for Analysis and Application* (7th ed.). Upper Saddle River, NJ: Prentice-Hall International, Inc.
- Gay, L. R. (1996). *Educational Research: Competencies for Analysis and Application*. Merrill Publishing
- Glynn, S. M., Brickman, P., Armstrong, N., & Taasoobshirazi, G. (2011). Science Motivation Questionnaire II: Validation with Science Majors and Nonscience Majors. *Journal of Research in Science Teaching*, 48(10), 1159–1176.
- Jones, B. A. (2014) ADDIE Model (Instructional Design).
- Kementerian Pendidikan Malaysia (2011) *Kurikulum Bersepadu Sekolah Menengah: Sains Tingkatan 3*. Putrajaya: Bahagian Pembangunan Kurikulum.
- Kementerian Pendidikan Malaysia. (2012) *Laporan Strategi Mencapai Dasar 60:40 Aliran Sains/ Teknikal: Sastera*. Malaysia: Ministry of Education.
- Kementerian Pendidikan Malaysia (2013) *Kurikulum Bersepadu Sekolah Menengah: Fizik Tingkatan 5*. Putrajaya: Bahagian Pembangunan Kurikulum.
- Kususanto, P., Fui, C. S., & Lan, L. H. (2012). Teachers' Expectancy and Students' Attitude Towards Science. *Journal of Education and Learning (EduLearn)*, 6(2), 87-98.
- Mueller, M. L., Dunlosky, J., Tauber, S. K., & Rhodes, M. G. (2014). The Font-size Effect on Judg-

- ments of Learning: Does it Exemplify Fluency Effects or Reflect People's Beliefs About Memory?. *Journal of Memory and Language*, 70, 1-12.
- Nicolaide, A. (2012) *Electromagnetics*. Brasov: Transilvania University Press.
- Nordin, A., & Lin, L. H. (2011). Hubungan Sikap Terhadap Mata Pelajaran Sains Dengan penguasaan Konsep Asas Sains Pelajar Tingkatan Dua. *Journal of Science & Mathematics Education*, 2, 89-101.
- Phang, F. A., Abu, M. S., Ali, M. B., & Salleh, S. (2014). Faktor Penyumbang Kepada Kemerosotan Penyertaan Pelajar dalam Aliran Sains: Satu Analisis Sorotan Tesis. *Sains Humanika*, 2(4), 63-71.
- Rohadi, N. (2016). Pemahaman Konseptual Mahasiswa Pendidikan Fisika FKIP Universitas Bengkulu Pada Diagram Medan Elektromagnet. *Jurnal Pendidikan Eksakta*, 1(1), 36-39.
- Sinatra, G. M., Brem, S. K., & Evans, E. M. (2008). Changing Minds? Implications of Conceptual Change for Teaching and Learning About Biological Evolution. *Evolution: Education and Outreach*, 1(2), 189-195.
- Vedder-Weiss, D. & Fortus, D. (2012). Adolescents' Declining Motivation to Learn Science: A Follow-up Study. *Journal of Research in Science Teaching*, 49, 1057-1095.
- Wagner, T. (2008) *The Global Achievement Gap*. New York: Basic Books.
- Zainudin, S., Halim, L. H., & Iksan, Z. (2016). How 60: 40 Policy Affects The Development of Science Curriculum in Malaysia. *Proceeding 7th International Seminar on Regional Education*. Malaysia, 5-7 November 2016.



TYPES OF PLASMODIUM AND THE EFFECT OF ENVIRONMENTAL FACTOR AGAINST MALARIA IN MANOKWARI, WEST PAPUA

N. Subekti*¹, M. Paiticen², E. I. J. J. Kawulur³, S. H. K. Sirait⁴,
S. Mohammed⁵

^{1,2}Biology Departement, Semarang State University, Semarang, Indonesia

³Biology Departement, Papua University, Manokwari, Indonesia

⁴Biology Education Departement, Papua University, Manokwari, Indonesia

⁵Department of Bioscience, Universiti Technology Malaysia

DOI: 10.15294/jpii.v7i3.14236

Accepted: January 23rd 2018. Approved: February 15th 2018. Published: September 20th, 2018

ABSTRACT

Malaria is a disease caused by parasitic protozoa (*Plasmodium*) carried by a vector of mosquitoes. There are approximately 100 million regions around the world at risk of malaria. One of the endemic areas of malaria in Indonesia is Papua. Manokwari is one of the districts in West Papua that has a high number of malaria patients. The purpose of this study was to investigate mosquitoes *Plasmodium* parasites, and malaria in West Manokwari District. The research procedure applied initial survey of the place where malaria vector was captured, capturing malaria vector, general environmental measurement, mosquito species identification, plasmodium examination on mosquito of malaria vector, and plasmodium examination on malaria patient. The total sample obtained from 3 areas was 1550 patients and 496 mosquitos with average numbers up to 150 mosquitos per area. The physical environment, including rainfall, temperature, humidity, altitude, and environmental conditions inside and outside the home greatly affected the incidence of Malaria in Manokwari, West Papua. Malaria is a serious health problem in Indonesia. The physical condition of the environment is the main factor influencing it. The results showed that the type of malaria vector found in West Manokwari region comes from two genera namely Culicidae and Anophelidae. Each malaria vector could carry infections from *Plasmodium vivax* or *Plasmodium falciparum*. There are two kinds of *Plasmodium* parasites that infected humans in Manokwari; *Plasmodium falciparum* and *Plasmodium vivax*.

© 2018 Science Education Study Program FMIPA UNNES Semarang

Keywords: plasmodium, vector, malaria, West Manokwari

INTRODUCTION

Malaria is a common disease in the tropics and subtropics, with approximately 100 million regions around the world at risk of malaria. Malaria is caused by parasitic protozoa (*Plasmodium*). Indonesia is one country that has a high percentage of malaria cases, especially in eastern Indonesia such as West Papua. Malaria cases occurring in Papua are caused by infections from

Plasmodium parasites, mainly *Plasmodium vivax*, *Plasmodium falciparum*, *Plasmodium malariae*, and mixed infections. Research conducted by Sandy (2014) suggests that the case of malaria in Papua has spread in almost all regions. One of the areas affected by malaria cases is West Papua with tertiana malaria and tropical malaria. This case continues to increase from 2013 until the end of 2014.

Research related to malaria disease in Papua region many of which were focused on the development of medical drugs to treat patients

*Correspondence Address

E-mail: nikensubekti@mail.unnes.ac.id

with malaria. One of which is research conducted by Laman et al. (2014) about testing artemisinin compound to overcome malaria disease in a patient. Manokwari is one of the districts located in West Papua Province. This is a new province of expansion from Jayapura. So, we need to observe the environmental impacts of land conversion from natural forest to residential ecosystems because it is a new city in the Papua province.

Manokwari has a fairly high population density. The increase in population in Manokwari is followed by the increasing number of malaria cases. The population of West Papua is 850,000 people, with rural population composition 70% and urban 30%. This high population is not comparable with the low awareness of community sanitation (Hetzl et al., 2017). Moreover, Manokwari District Health Office shows that the service access of Wastewater Distribution System in Manokwari is still low. This condition underlying to conduct research related to malaria in a rural area.

Manokwari, West Papua is the place where about 70% of malaria disease suffered by the surrounding community is a malaria disease caused by two types of Plasmodium parasites. This is indicated by research conducted by Arif (2009) which states that the most dominant type of Plasmodium with the number of percentages reaches 65% in Anopheles mosquitoes in some areas in West Manokwari District is *P. vivax*. Then the second dominant one is *P. falciparum*. Research on malaria in Papua is still limited to the spread of malaria, various methods of treatment, and resistance levels of malaria.

There is no data on the relationship between mosquito species, Plasmodium species in mosquitoes and Plasmodium infecting malaria patients. This underlies the researcher's curiosity to examine more about mosquitoes, Plasmodium parasites, and malaria in West Papua, especially in west Manokwari district which is expected to produce data that can be used as a reference for further research and become information for the community.

METHODS

Tools and Materials

Equipment used in this research are sample bottle, plastic sample, microscope, object glass, glass deck, tweezers, petri dish, thermometer, hygrometer, mosquito type identification book, stationery, camera, loop 10x, loop 20x, book type Plasmodium, aspirator, strap, rubber band, flashlight, a set of light trap tools, scissors, dropper pi-

pes, needles, and test tubes.

The materials used in this research are the sample of mosquito, giemsa, alcohol, cotton, tissue, ether, clear clay, physiological salt, methanol, emersi oil, mosquito sprayer, formalin 5%, human, and cow. The study was conducted for three months with the location of mosquito sampling conducted in AmbanPantai and Sowi, while the examination of Plasmodium parasite in malaria patients was done at RSUD Manokwari and PuskesmasSanggeng. Identification of types of Anopheles and Plasmodium on Anopheles mosquitoes was conducted in Basic Biology Laboratory of UNIPA Manokwari.

Research Procedures

Research procedures include survey activities, mosquito sampling, mosquito species identification, Plasmodium examination on mosquitoes, and examination of plasmodium in human blood. The surveys were conducted at pre-determined sites in Amban, Amban Pantai and Sowi areas in West Manokwari District. The determination of each location is based on the average flight habit of the female mosquitoes. The flight distance from the female Anopheles mosquito is 2.5 km, so it is taken a distance of five km which aims to reduce the occurrence of catching the same species.

Mosquito sampling was conducted in West Manokwari district using survey method with purposive sampling. Mosquito sampling is done in 4 ways: man landing place (where mosquito land on the human body), light trap method, using livestock feed (cow), and with a mosquito sprayer. Then the measurement of temperature and humidity of the surrounding environment are to find out the general state of the environment.

Identification of the type of mosquitoes is done in the Laboratory of Biology of the University of Papua with an identification guide. The identification of Plasmodium parasite was done by Gatton (2015) method by sampling the salivary glands made into a smear preparation with giemsa additives. Mosquito blood smear preparations were then observed using a microscope with the magnification of 100 for parasites to be seen. Data collection on Plasmodium type in humans was done by taking data in the laboratory of Manokwari Hospital and Puskesmas Sanggeng in West Manokwari District. The identification method of Plasmodium in patient's blood was adjusted to the method used by Manokwari Hospital Laboratory.

Data Analysis

The density of Mosquito Species

The data of mosquito density was then calculated using the standard method formula from WHO (2013) namely:

(a). MBR (Number of mosquitoes that bite people per hour)

$$= \frac{\text{Number of mosquitoes captured by human feed}}{\text{Number of Capture} \times \text{Time of Capture (hours)}}$$

(b). MHD (The number of mosquitoes perching and captured per person per hour)

$$= \frac{\text{Number of mosquitoes perching and caught}}{\text{Number of capture} \times \text{time of capture (hours)}}$$

(c). DMH (The density of mosquitoes per house)

$$= \frac{\text{Number of mosquitoes perching caught in the house}}{\text{Number of houses the mosquitoes are captured}}$$

(d). Sporozoite rate

$$= \frac{\text{Number of vector types containing sporozoid}}{\text{Number of the same vector types being dissected}}$$

The parasitic density was calculated by observing a sample object of a blood smear under a microscope then calculating the number of parasites per object. If there is no parasite, then it is denoted by the sign (-). If there are 1-10 parasites per object, it is expressed by the sign (+). If there are 11-100 per film expressed with the sign (++).

Data on the type of Plasmodium parasite in humans are analyzed descriptively and presented in the form of tables and graphs.

RESULTS AND DISCUSSION

Results of Plasmodium Examination in Human Blood

Based on the results of research conducted in the examination of plasmodium in human blood, it was revealed that there are two types of plasmodium. The examination was done by two methods namely Rapid Test Diagnosis (RTD) and manual inspection using the microscope.

Table 1. Results of Plasmodium Examination in Human Blood

Category of Patient	Types of Plasmodium	Infection Categories and Number of Patients Infected	Type of Malaria (number of patients)	Prevalence (%)		
Children	PF = 171	+ = 106	Tropica (175)	29.7		
		++ = 61				
		+++ = 4				
		+ = 4				
	GF = 4	++ = 0				
		+++ = 0				
	PV = 180	+ = 102			Tertiana (184)	31.2
		++ = 73				
		+++ = 5				
		+ = 4				
GV = 4	++ = 0					
	+++ = 0					
Adults	N = 234		Tropica (369)	38.5		
		+ = 268				
		++ = 87				
		+++ = 7				
	GF = 7	+ = 6				
		++ = 1				
	PV = 275	+++ = 0			Tertiana (284)	29.6
		+ = 187				
		++ = 78				
		+++ = 10				
GV = 9	+ = 7					
	++ = 2					
N = 304	+++ = 0		31.7			

Information

PF : *Plasmodium falciparum*
 N : Normal
 GF : Gamet falciparum
 Children : Under 12 years
 PV : *Plasmodium vivax*
 Adult : Above 13 years
 GV : Gametvivax
 + : 1-10 parasite/ film
 ++ : 11-100 parasite/ film
 +++ : More than 100 parasite/ film

Table 1 shows data on the results of plasmodium in human blood. Based on Table 1, it can be seen that from 1550 patients who performed blood tests, as many as 1018 patients were positively affected by malaria. The category of patients infected by malaria is divided into two, namely children and adults. There are two types of plasmodium that infect the patient na-

mely *P. falciparum* and *P. vivax*. When infecting patients, both types of plasmodium are in the adult and gamete phases with infection categories ranging from small (+), moderate (++), to multiple (+++). This indicates that malaria suffered by patients consists of malaria tertiana and tropica.

Karyana et al. (2008) mentioned that the average patient affected by malaria is a patient of children, pregnant women, and immigrants. This is less appropriate with the results of conducted research stating that the largest number of patients come from the adult group. However, because of no more detailed categorization of patients such as the patient's general condition, address, and history of the disease, there is a possibility that of the number of patients examined included pregnant women and immigrants. Figure 1 shows the number of patients infected with plasmodium.

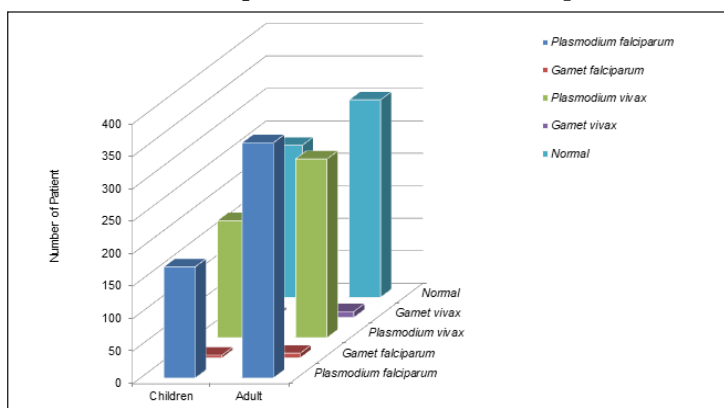


Figure 1. Number of Patients Infected by Two Types of Plasmodium and by Their gamet Phase

Based on the picture above, it can be seen that patients who perform the blood test are mostly adult patients (900 patients), while child patients are up to 600 patients. The category of adult patients is a group of patients aged 13 years and above consisting of adolescents in SLTA, pregnant women, parents, and immigrants. The categories of pediatric patients consist of infants, toddlers, elementary and junior high school children.

Plasmodium examination of patients only categorizes patients by age so it cannot be known in more detail about the general condition of patients such as conditions of pregnancy, immigrant, infants, and toddlers. The number of patients who have infections is 1018 patients, from the total number of 1550. Type of plasmodium that dominates infection in children and adult patients is *P. falciparum*. *Plasmodium falciparum* infected 541 patients. Previous research performed by Kwenti et al. (2017) found that *P. falcipa-*

rum was the only species causing clinical malaria in the target population. Plasmodium phase that causes many infections is trophozoite phase compared to gamete phase. Figure 2 below is a screened image showing the infection of plasmodium in adult (trophozoite) and gamete phase.

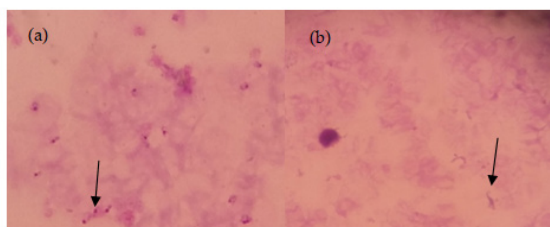


Figure 2. The Infected Blood Samples of *Plasmodium falciparum*. (a) Introphozoite Phase and (b) in Gamet Phase.

Based on Figure 2, it can be seen that the plasmodium infection of trophozoite falciparum is characterized by the appearance of red spots on red blood cells or erythrocytes. Figure

2a above shows *Plasmodium falciparum* infection in the trophozoite phase with infection category +++ which indicates severe infection in human erythrocytes. The characteristic of *Plasmodium falciparum* infection in trophozoite phase is characterized by red spots on the edges of red blood cells. According to Weeratunga et al. (2016), it is suggested that the characteristics of *Plasmodium falciparum* infection in the trophozoite phase are characterized by red spots on erythrocytes. The red spots on the edges of the erythrocytes are trophozoite from plasmodium which will then develop into schizont.

Schizont is a phase of development of plasmodium which is the result of the development of trophozoite. Schizont phase is a phase before gamete formation of *P. falciparum*. Figure 2b shows *P. falciparum* infection in human erythrocytes in gamete phase. Gamete phase is characterized by the appearance of red spots with a lot of intensity in erythrocytes. The erythrocyte will usually dilate and then over time will break apart with the development of gametes in erythrocyte.

Infections of *P. falciparum* result in tropical malaria disease. Buffet et al. (2010) mentioned that tropical malaria is one of four types of malaria known to infect humans. According to Zhang et al. (2016) malaria that can infect humans are tropical malaria, malaria tertiana, malaria malariae or quartana, and malaria ovale. The four types of malaria can be transmitted by a vector of mosquitoes. The vector of malaria is a mosquito of the genus anophelidae, but there are also some of the genus Culicidae that are reported to spread the plasmodium that causes malaria.

Another plasmodium found from the patient's blood test results is *P. vivax*. Plasmodium causes the patient to suffer from malaria tertiana. Groger et al. (2017) stated that the characteristics of patients affected by malaria tertiana include, rising body temperature, sweaty body, weak body condition and sometimes accompanied by dizziness or a headache. Figure 3 below shows the observed images of *P. vivax* infection in the trophozoite and gamete phases.

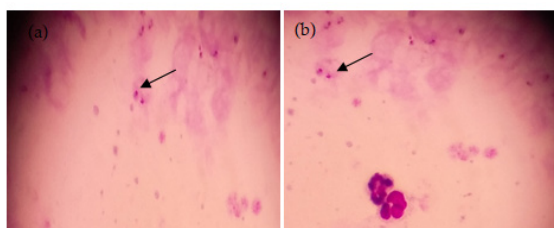


Figure 3. Sample of Human Erythrocyte Infected by *Plasmodium vivax*. (a) Introphozoite Phase and (b) in Gamet Phase.

Figure 3 shows an infection of *P. vivax* in human erythrocytes. Based on the results of the examination, patients infected by *P. vivax* are 468 of the total of 1012 patients infected by plasmodium. Infection by *P. vivax* causes the patient suffering from tertiana malaria disease. The characteristics of infection by *P. vivax* in human erythrocyte are at first glance almost identical. The difference in features of *P. vivax* infection with *P. falciparum* lies in the form of the infected erythrocyte.

Currently, it is known that malaria which is commonly encountered especially in the Southeast Asia region of malaria tropica and tertiana. Based on Table 1, it is known that the prevalence of malaria tropica disease is greater than malaria tertiana. This is in accordance with the statement of Karyana et al. (2008) which stated that in the Papua region, the highest prevalence of malaria cases is malaria tropica. The results showed that the total prevalence of tropical malaria was 68.2% while malaria tertiana reached 60.8%.

Data on prevalence calculations from both malaria types show that infection of malaria tropica is higher than malaria tertiana. Based on the results of a survey conducted on patients at Manokwari District Hospital, the results showed that tropical malaria is suffered by almost all age groups. In a day, new patients infected with tropical malaria look healthy and only have a fever with a high enough temperature. While patients with malaria tertiana look weak, sweaty, and get the high fever.

In areas like Papua, adults infected with malaria have no clinical symptoms of infected malaria. However, the results of the blood test show positive infection of malaria. This condition accords with the previous finding of Sorontou & Pakpahan (2015) that all of the malaria cases in Jayapura district Papua do not show any clinical symptom or called as asymptomatic. This is due to the immunity that occurs due to recurrent infections. The spleen usually enlarges in the first severe infection or after several infections. West Manokwari is one of the areas classified as malaria endemic. Survey on local residents shows that malaria is commonly suffered by people from children to adulthood especially productive age. Malaria incidents mostly happened on toddlers and productive age (Ogutu et al., 2009).

The Result of Capturing Malaria Vector

The location of the capturing activity is done in three different places with three-time

repetition. The method used for capturing the object is the method of man landing place where human bait is used to catch the mosquito. Then, the calculation of the number of per-

ching per hour is up to four repetitions. The capturing results revealed the data shown in Table 2.

Table 2. Identification of Malaria Vector Captured in 3 Areas

Location	MBR (%)	MHD (%)	DMH (%)	Types of Mosquito (heads)	Total Number of Mosquitoes (heads)
Amban	18	4, 5	8	Anophelidae (10) Culicidae (153)	163
Amban Pantai	15, 8	6	6,3	Anophelidae (21) Culicidae (122)	143
Sowi	21, 1	9, 5	12, 3	Anophelidae (33) Culicidae (157)	190

MHD: *Man Hour Density*

DMH: *Density of Mosquito per House*

Based on the above table, the sampling locations are three different areas. Each location is selected based on environmental conditions and altitude. The first location taken is the Amban area. Amban is an urban area in West Manokwari District. The amban area consists of Amban town and Amban beach. Based on the survey results, Amban beach is an area that has very few populations. The environment around Amban Beach has a lot of vacant lands. Additionally, there are many puddles and ditches around the houses.

Amban Beach is part of the Amban urban area. Amban region itself is included in the city area with a considerable population compared to the Amban Coast area. In the Amban area, the city still has vacant lots and gardens. Taviv et al. (2016) stated that the mosquito breeding habitat is diverse. The mosquito of the genus *Anopheles* likes a place with high gloom, low temperature, and low light intensity. These conditions are crucial for microbial and algal community development especially for aquatic mosquitoes satges (Kweka et al., 2015). Moreover, the light intensity can also affect their flight and oviposition behaviour. They are normally nocturnal, oviposit at twilight and during moon-lit flight (Kampango et al., 2011)

Table 2 shows the results of captured mosquitoes which are malaria vector. Based on Table 2, it can be seen that there are two types of mosquitoes of malaria vector that belong to Culicidae and Anophelidae. Both types of mosquitoes are found throughout the fishing grounds. In the Amban area, the mosquitoes found were 163 heads with ten heads of genus *Anphelidae* and 153 heads of the genus *culicidae*. The number of mosquitoes of the genus *Culicidae* is more than the

genus *Anophelidae*. This can be caused by some environmental factors such as the temperature and humidity of the surrounding air, the intensity of light, the presence of water puddles or the location of mosquito breeding is appropriate with the habitat of the mosquitoes of genus *Culicidae*.

Anophelidae mosquitoes found in Amban area are only ten tails. The small number of captured *Anophelidae* is because Amban area is a region that can be categorized as a city area. The mosquitoes of the genus *Anophelidae* are mosquitoes that like the breeding environment with low light intensity like in the swamps. Amban territory that has been categorized as a city is not suitable as a mosquito environment of the genus *Anophelidae*.

The results of the mosquito vector in Amban Beach and Sowi areas also show that the population of the genus *Culicidae* mosquito is more common than the genus *Anophelidae*. The main characteristic of the distinction between *Culicidae* and *Anophelidae* lies in the length of proboscis and palpus. The mosquitoes of the genus *Culicidae* have palpus that is shorter than the proboscis, whereas the mosquitoes of the genus *Anophelidae* have palpus that have almost the same length or longer than their proboscis. Additionally, the wing of mosquitoes of the genus *Anophelidae* has a distinctly luminous darkness whereas the *Culicidae* has no dark shades of light. The wings of *Culicidae* are patterned black on the bones of their wings.

Research conducted by Taviv et al. (2016) showed that the population of mosquitoes of genus *Culicidae* is more common than the genus *aphelidae*. This is in line with the observed data obtained in the West Manokwari area. The results of the MBR or Man Biting Rate calcula-

tions show that in the three locations, the average number of mosquitoes that bite humans each day is above 15%. MBR figures indicate that the number of people bitten by mosquitoes every day is quite a lot. This becomes one of the opportunities for the infection of malaria.

The results of the data analysis also counted the number of mosquitoes that bite humans every hour or so-called MHD (Man Hour Density). Table 2 shows the number of analysis results of MHD in the three locations which have averaged above 4% of the total average number of 150 mosquitoes. The percentage 4% indicates that every 1 hour, the average number of mosquitoes that bite the population is above six heads. This figure is considered quite high and has the potential to become one of the causes of the population infected by malaria.

Transmission of vector diseases such as malaria is influenced by many factors. One of the factors that have been known to have an association with malaria is the topographic area which is closely related to transmission pattern. The height of place can also be a determining factor. Every 100-meter increase then the difference in air temperature with the original place is 0,5°C. If the difference in the place is high enough, then the temperature difference will also affect many other factors including influence by the growth and the spread of mosquitoes. The optimum temperature, between 20-30 °C,

is required for mosquitoes to breed in both the aquatic and adult phases (Githeko et al., 2010).

According to the Ministry of Health of the Republic of Indonesia, the location of transmission of vector infectious diseases is determined by the type of topography and the existence of vectors that can adapt to the environment and lifestyle of the community. Idris et al. (2016) stated that malaria disease in the tropics area happens on rapid population growth, migration, and poor sanitation. The dominant factor causing malaria in Manokwari is poor sanitation, seen on their poor environmental hygiene and waste processing. Based on the location of vector infectious diseases, it should be noted that several aspects are zoogeography division, altitude, geographical location, geological arrangement, and area. Moreover, the behavior of each different type of vector also needs to be considered.

Habitat Characteristic of Malaria Vector

Examination of habitat character of malaria vector was performed in 3 different locations. The location of the observed character is the location where the malaria vector has been previously identified and examined. Type of habitat taken consists of 3 types namely in the house, yard, and around ponds and puddles. The following table 3 is the result of examination of the habitat character of the captured malaria vector.

Table 3. Habitat Characteristic of Malaria Vector in 3 Areas Observed

Location	Type of Habitat	Type of Mosquito	Characteristics of Habitat		
			Shades	The temperature of Environment (°C)	Humidity (%)
Amban	Inside House	Culicidae Anophelidae	Sheltered	32	73
	House Yard	Culicidae	Sheltered	31	73
	Puddle	Culicidae Anophelidae	Well lighted	32	73
Amban Pantai	Inside House	Anophelidae	Sheltered	32	74
	House Yard	Culicidae	Well lighted	31	74
	Puddle	Culicidae	Well lighted	31	74
Sowi	Inside House	Culicidae Anophelidae	Sheltered	32	74
	House Yard	Culicidae Anophelidae	Sheltered	32	75
	Puddle	Culicidae Anophelidae	Sheltered	31d	75

Based on Table 3, it can be seen that the category of selected sampling environment is in the house, yard, and pond or puddle around the house. Each environment has its reasons that

make the environment potentially as a place of existence of mosquitoes. The home environment is considered to be one of the potential places for mosquitoes due to several factors, namely the hu-

midity in the house tends to be higher than the humidity in the yard environment. This condition supports the mosquito habitat. In some corners of the house, there are places such as humid showers. The bathroom is one of the most important targets for the presence of a mosquito as a reservoir that can potentially be a mosquito-laying environment.

The results indicated that the air temperature had a relationship with the incidence of malaria in Manokwari region. The air temperature measurements carried out during the study and also reported by BMG West Papua showed that the average maximum and minimum temperature limits were still within the temperature range that was in accordance with the survival of malaria mosquitoes. The suitability of the air temperature in this research location made malaria mosquitoes survived and reproduced optimally.

Air temperature is a transmission of malaria. Malaria would develop along with the development of mosquitoes. If the temperature of the region allows the anopheles mosquitos to live, then malaria will also develop in the region. Temperature is a major factor in the development of mosquitoes. The sporogonic cycle takes 9-10 days. The temperatures of $>30^{\circ}$ C will have an impact on the short incubation period of parasites so that the proliferation of malaria becomes faster.

Humidity is one of the main factors of physical environmental conditions associated with malaria. Direct humidity measurements at the study site showed an average humidity of 73-75%. This high humidity was influenced by evaporation and the presence of plant growths such as sago, nipah and others. This degree of air humidity could still be adapted by plasmodium. The humidity of $>60\%$ will cause the significant increase in infection rates.

Rainfall is an environmental factor that greatly affects the life of anopheles mosquitoes. The results revealed that rainfall in the research location was high. This high rainfall was influenced by abundant coastal water vapor. High rainfall causes a lot of water. This pool of water causes the mosquito to optimally lay eggs.

At the study site, the researchers found that the pH of the water was one of the factors causing malaria. 6-7 pH of water is the normal level for the survival of the Anopheles mosquito larvae. The normal pH levels strongly support the larval and larvae development of Anopheles mosquitoes. Anopheles larvae are very fond of normal pH conditions.

The height of the research site was a factor that influenced the incidence of malaria in the Manokwari region. The results showed that the study location was in the lowlands. At low research locations, mosquitoes had a wide range of flying. The height of the place is related to temperature, resulting in the lowlands' high temperature than the plateau.

The physical condition of the houses in the Manokwari community was generally very simple since it was made of used boards, bamboo, thus, holes in the wall of the house were easily found. These holes were not coated with gauze, so that the anopheles mosquitoes could freely enter the house and attacked the occupants. The houses' cleanliness both inside and outside was not well-maintained. Much dirt, many untreated tools, and stuffy house conditions made the anopheles mosquitoes liked such condition. Outside the house, there were often piles of used goods and scattered garbage. Overall, the condition of dirty houses was the cause of malaria in Manokwari, West Papua.

The yard of the house becomes one of the locations chosen to be included as the location of the mosquito environment. The underlying selection of home yard as a location of catching mosquito is due to the existence of plants around the home yard. In addition to the temperature and humidity of biotic factors, plants become one important factor where mosquitoes are breeding. When laying eggs, several species of mosquitoes look for locations with plants around it as the place for the candidate of the mosquito larvae.

The location of the third arrest is selected in the puddle. Water puddles become one of the important locations as a breeding ground for mosquitoes, especially spawning. Mosquitoes need a water surface to place the eggs. Female mosquitoes will put their eggs on the surface of the water that will hatch and develop into larvae. In addition, water becomes one of the important components for mosquito breeding because the aqueous environment tends to be moist and the temperature is low.

Based on the data, there were two types of mosquitoes captured, namely genus Culicidae and Anophelidae. The mosquitoes of the genus Culicidae are found in all locations both inside the house, the yard, and the puddles. While the mosquitoes of the genus Anophelidae are found only in homes and pools of homes. Differences in the environment where two types of mosquitoes are found shows that both have some different breeding characteristics.

Temperature and humidity in the capturing location of mosquito are quite effective as a living environment and breeding place for mosquitoes. Temperature and humidity greatly affect the life of mosquitoes. According to the Ministry of Health of the Republic of Indonesia, the rain will affect the rise of air relative humidity and increase the number of vector breeding places (breeding places). Air relative humidity is the amount of moisture content in the air. If there is a large water shortage in the air, then this air has a large evaporation power. Respiratory system in mosquitoes is using air pipe (trachea) with holes in the mosquito body wall called spiracle. The spiracle is open without any regulatory mechanism (Mamai et al., 2016). At low humidity, it will cause the evaporation of water from inside the body of the mosquito that can lead to the drying of body fluids of mosquitoes. Umaru & Akogun (2015) suggested that ideal air and water temperature for larvae and adult *Anopheles* mosquito is respectively 26.5-28°C and 33-36°C with relative humidity of approximately 60-75%. The peak biting time for *Anopheles spp* was between 19:00 and 20:00 h but continued throughout the night outdoors. The peak biting indoors was between 22:00 and 23:00 h (Liu et al., 2011).

According to Correia et al. (2015) and Fernández et al. (2017), *Anopheles*'s breeding

habitats are classified into two categories, i.e., flowing water habitats and aquatic habitats. Flow water habitats can be slow-flowing water channels, irrigation canals, and streams that flow swiftly or slowly. *Anopheles* larval habitats found close to residential areas indicate the magnitude of the transmission risk of malaria if the habitat has a vector that breeds. The distance between the vector and residential breeding habitats is one of the risk factors for malaria incidence. *Anopheles* larvae breeding habitat is found to be commonly found in aquatic plants. Plants are very influential on the life of mosquitoes, among others, as a place to lay eggs, shelter, where to find food and shelter for larvae and resting place for mosquitoes (Rejmánková et al., 2013).

Results of Plasmodium Inspection on Malaria Vectors

The examination was carried out with samples of mosquitoes captured at three locations in West Manokwari District, i.e., Amban, Amban Pantai, and Sowi. Based on the results of the examination (Table 4), it can be seen that there are two types of plasmodium in the vector examined, *P. vivax* and *P. falciparum*. The results show that the two types of plasmodium could be found in both the malaria vector of Anophelidae and Culicidae.

Table 4. Results of Plasmodium Examination on Malaria Vectors

Location	Type of Mosquito	Examined Mosquito (Heads)	Type of Plasmodium		Sporozoid Rate (%)
			PF	PV	
Amban	Anophelidae	7	+	-	70
		3	-	-	
Amban Pantai	Culicidae	153	-	-	0
	Anophelidae	11	+	-	52,3
		10	-	-	
		3	+	-	
Culicidae	119	-	-	2,6	
Sowi	Anophelidae	9	+	-	36,3
		3	-	+	
		11	-	-	
	Culicidae	157	-	-	

The intensity of *P. falciparum* discovery in the malaria vector is higher than that of *P. vivax*. This is consistent with malaria patients who are mostly infected with *P. falciparum* compared to *P. vivax*. Elyazar et al. (2011) explained that *P. falciparum* and *P. vivax* were the most commonly occur together in Indonesia, but *P. falciparum* dominated in more locations than *P. vivax*

(60% vs 30%). The number of malaria vector which positively contains plasmodium is still small compared to those who negatively contain plasmodium. The least plasmodium found in malaria vectors indicates that there has been a decrease in the malaria-spreading vector that affects the reduced number of malaria-infected patients.

Based on data from West Papua Provincial Health Office 2015, the data show that malaria patients in West Manokwari District reach 50% of the total population. When it is compared to the examination data on the number of malaria patients in western Manokwari hospital, it can be predicted that the number of malaria patients decreased. A decrease in the number of malaria patients shows that efforts to overcome the spread of malaria disease and show a good impact than ever before. Nevertheless, this study provides relevant information on what can be done in the prevention and control of malaria effectively in these areas. In addition, this information then leads people to maintain the environmental health to prevent malaria.

CONCLUSION

Based on the results of this study it can be concluded that the type of mosquitoes which are the vectors of malaria found in West Manokwari region consists of two genera namely genus Culicidae and Anophelidae. Each malaria vector can carry infections from both *P. vivax* and *P. falciparum*. From the results of the examination, plasmodium which is commonly found is *P. falciparum*. Plasmodium parasites that infect humans are *P. falciparum* and *P. vivax* with a single type of infection in which the patient is only infected by one type of plasmodium and double that is the patient infected with more than one type of plasmodium. The environmental factors that affected the proliferation of Anopheles mosquitoes included temperature, humidity, rainfall, pH, and the physical condition of the house.

ACKNOWLEDGEMENT

This research was supported by Ministry of Research, Technology and Higher Education of the Republic of Indonesia.

REFERENCES

- Arif, N. (2009). Plasmodium yang Dominan dalam Nyamuk Anopheles betina (*Anopheles* spp.) pada Beberapa Tempat di Distrik Manokwari Barat. *J. Sains UNIPA*, 3(2), 4-6.
- Buffet, P. E., Poirier, L., Zalouk-Vergnoux, A., Lopes, C., Amiard, J. C., Gaudin, P., ... & Valsami-Jones, E. (2014). Biochemical and Behavioural Responses of the Marine Polychaete *Hediste Diversicolor* To Cadmium Sulfide Quantum Dots (CdS QDs): waterborne and dietary exposure. *Chemosphere*, 100, 63-70.
- Correia, W., Varela, I., Spencer, H., Alves, J., & Duarte, E. H. (2015). Characterization of Mosquito Breeding Sites in the Cape Verde Islands With Emphasis On Major Vectors. *Int J Mosq Res*, 2(3), 19-29.
- Elyazar, I. R., Hay, S. I., & Baird, J. K. (2011). Malaria Distribution, Prevalence, Drug Resistance and Control in Indonesia. In *Advances in parasitology* (Vol. 74, pp. 41-175). Academic Press.
- Fernandez, M.D.C.M., Flores, Y.H., & Nuviola, D.L. (2017). Habitat Characterization and Spatial Distribution of *Anopheles* sp. Mosquito Larvae in Luanda, Angola. *Annals of Community Medicine and Practice*, 3(10), 1016-1027.
- Gatton, M. (2015). Microscopy for the Detection, Identification and Quantification of Malaria Parasites on Stained Thick and Thin Blood Films In Research Settings. Geneva: World Health Organization.
- Githeko, A. K., Ogallo, L., Lemnge, M., Okia, M., & Ototo, E. N. (2014). Development and Validation of Climate and Ecosystem-Based Early Malaria Epidemic Prediction Models in East Africa. *Malaria journal*, 13(1), 329-334.
- Groger, M., Fischer, H. S., Veletzky, L., Lalremruata, A., & Ramharter, M. (2017). A systematic review of the clinical presentation, treatment and relapse characteristics of human Plasmodium ovale malaria. *Malaria journal*, 16(1), 112-119.
- Hetzel, M. W., Pulford, J., Ura, Y., Jamea-Maiasa, S., Tandrapah, A., Tarongka, N., ... & Siba, P. M. (2017). Insecticide-Treated Nets and Malaria Prevalence, Papua New Guinea, 2008–2014. *Bulletin of the World Health Organization*, 95(10), 695-702.
- Idris, Mulyadi, Pertiwi, N., Mandra, A.S., & Dirawan, G.D. (2016). Behavior And Environmental Sanitation in Malaria Patients At Work Area of the Local Government Clinic Pundata Baji Pangkep Regency. *International Journal of Applied Environmental Sciences*, I(3), 773-783.
- Kampango, A., Cuamba, N., & Charlwood, J. D. (2011). Does Moonlight Influence the Biting Behaviour of *Anopheles Funestus*?. *Medical and Veterinary Entomology*, 25(3), 240-246.
- Karyana, M., Burdarm, L., Yeung, S., Kenangalem, E., Wariker, N., Maristela, R., ... & Ebsworth, P. (2008). Malaria Morbidity in Papua Indonesia, an Area with Multidrug Resistant Plasmodium vivax and Plasmodium falciparum. *Malaria Journal*, 7(1), 148-156.
- Kemendes. 2014. Riset Kesehatan Dasar 2013. Laporan
- Kweka, E. J., Tenu, F., Magogo, F., & Mboera, L. E. (2015). Anopheles gambiae sensu stricto Aquatic Stages Development Comparison between Insectary and Semifield Structure. *Advances in Zoology*, 1(1), 22-29.
- Kwenti, T. E., Kwenti, T. D. B., Njunda, L. A., Latz, A., Tufon, K. A., & Nkuo-Akenji, T. (2017). Identification of the Plasmodium Species in

- Clinical Samples from Children Residing in Five Epidemiological Strata of Malaria in Cameroon. *Tropical Medicine and Health*, 45(1), 14-21.
- Laman, M., Moore, B. R., Benjamin, J. M., Yadi, G., Bona, C., Warrel, J., & Robinson, L. J. (2014). Artemisinin-naphthoquine Versus Artemether-lumefantrine for Uncomplicated Malaria in Papua New Guinean Children: An Open-label Randomized Trial. *PLoS medicine*, 11(12), 73-80.
- Liu, X. B., Liu, Q. Y., Guo, Y. H., Jiang, J. Y., Ren, D. S., Zhou, G. C., ... & Chen, Y. (2011). The Abundance and Host-Seeking Behavior of *Culicine* Species (Diptera: Culicidae) and *Anopheles sinensis* in Yongcheng city, People's Republic of China. *Parasites & Vectors*, 4(1), 221-232.
- Mamai, W., Mouline, K., Parvy, J. P., Le Lannic, J., Dabiré, K. R., Ouédraogo, G. A., ... & Simard, F. (2016). Morphological changes in the spiracles of *Anopheles gambiae* sl (Diptera) as a response to the dry season conditions in Burkina Faso (West Africa). *Parasites & Vectors*, 9(1), 11-24.
- Nasional Ed. Jakarta: Badan Litbang Kesehatan
- Ogutu, B. R., Apollo, O. J., McKinney, D., Okoth, W., Siangla, J., Dubovsky, F., ... & Malkin, E. (2009). Blood Stage Malaria Vaccine Eliciting High Antigen-Specific Antibody Concentrations Confers No Protection to Young Children in Western Kenya. *PLoS one*, 4(3), 47-56.
- Rejmánková, E., Grieco, J., Achee, N., & Roberts, D. R. (2013). Ecology of Larval Habitats. In *Anopheles mosquitoes-New insights into malaria vectors*. InTech.
- Sandý, S. (2014). Bionomy of *Anopheles Punctulatus* Group (*Anopheles Farauti*, *Anopheles Koliensis*, *Anopheles Punctulatus*) Malaria Vector in Papua Province. *BALABA: Jurnal Litbang Pengendalian Penyakit Bersumber Binatang Banjarnegara*, 10(1), 47-52.
- Sorontou, Y., & Pakpahan, A. (2015). Genetic Diversity in MSP-1 Gene of *Plasmodium Falciparum* and its Association with Malaria Severity, Parasite Density, and Host Factors of Asymptomatic and Symptomatic Patients in Papua, Indonesia. *International Journal of Medical Science and Public Health*, 4(11), 1584-1593.
- Taviv, Y., Saikhu, A., & Sitorus, H. (2016). DBD Control through Utilization of Monitoring of Larvae and Betta Fish in Palembang. *Buletin Peneltitian Kesehatan*, 38(4), 198-207.
- Umaru, N.F. & Akogun, O.B. (2015). Physical Factors Associated with *Anopheles* and *Culex* Mosquitoes' Survival in Captivity in Yola, Nigeria. *International Journal of Modern Biological Research*, 4(1), 16-24.
- Weeratunga, P., Rathnayake, G., Sivashangar, A., Karunanayake, P., Gnanathanan, A., & Chang, T. (2016). *Plasmodium Falciparum* and *Mycoplasma Pneumoniae* Co-Infection Presenting with Cerebral Malaria Manifesting Orofacial Dyskinesia and Haemophagocytic Lymphohistiocytosis. *Malaria Journal*, 15(1), 461-470
- World Health Organization. (2013). *Malaria Entomology and Vector Control*. World Health Organization. Ingram Publishing. Geneva.
- Zhang, Q., Sun, J., Zhang, Z., Geng, Q., Lai, S., Hu, W., ... & Li, Z. (2016). Risk Assessment of Malaria in Land Border Regions of China in the Context of Malaria Elimination. *Malaria Journal*, 15(1), 546-553.



ECOLOGICAL STUDIES OF *Oryctes rhinoceros* LARVAE CONTROLLED BY *Metarhizium anisopliae* AND ENTHOMOPATOGENIC NEMATODES

D. R. Indriyanti*¹, R. Rahmawati², B. Priyono³, M. Slamet⁴, F. Z. Huyop⁵

^{1,2,3}Biology Department, Faculty of Mathematics and Natural Sciences,
Universitas Negeri Semarang, Indonesia

⁴Estate Crop Protection Board in Salatiga, Central Java, Indonesia

⁵Faculty of Biosciences and Medical Engineering, Universiti Teknologi Malaysia, Malaysia

DOI: 10.15294/jpii.v7i3.14239

Accepted: May 23rd, 2018. Approved: August 31st, 2018. Published: September 20th, 2018

ABSTRACT

Oryctes rhinoceros L. (Coleoptera: Scarabaeidae) is a pest of coconut plant. *Metarhizium anisopliae* and Entomopatogenic Nematodes are biological control agents. The purpose of this study was to determine the ecology of insect pests controlled by fungi *Metarhizium anisopliae* (MET), Entomopatogenic Nematodes (NEP) and the mixture of MET and NEP for controlling *O. rhinoceros* larvae on the field. *M. anisopliae* used was in the form of kaolin powder formulation (WP). The nematodes used were *Heterorhabditis* sp. Nematodes formulation was in the form of liquid with sponge medium contained 10 x 10⁶ NEP in every pack. The study used Randomized Block Design with 3 types of treatment and 10 times repetition on 10 larvae. The result of six weeks treatment showed that the highest larval mortality was obtained from the treatment with the mixture of MET and NEP. Biological control using two biological agents (MET and NEP) is better than only MET or NEP. The benefit of research is for the recommendation of *O. rhinoceros* larvae control.

© 2018 Science Education Study Program FMIPA UNNES Semarang

Keywords: application of *Metarhizium anisopliae*, Entomopatogenic Nematodes, *Oryctes rhinoceros*, biological control.

INTRODUCTION

Oryctes rhinoceros beetle is one of the major pests attacking coconut crops in Indonesia (Indriyanti et al., 2018). It has reportedly attacked the coconut plants in Africa, especially in Pacific Island (Jackson, 2009), in Malaysia (Manjeri et al., 2014), Arab (Khudhair et al. 2015). Jepara, located on the Shore of Java Sea, Indonesia (Indriyanti et al., 2018). We have studied *O. rhinoceros* in Jepara, Indonesia since 2015. The beetle destroy the coconut shoot, attacks on growing point of stem while the larvae live in the soil or

dead coconut trunk (Moslim et al., 2011). Control larvae with pesticides causes various negative impacts on the environment such as soil, water, and air (Amalia & Yusa, 2018). One of the biological agent to control the larvae of *O. rhinoceros* is *Metarhizium anisopliae* (Latifian & Rad, 2012). It is a parasitic fungus that infect many insects (Agali et al., 2017). Beside fungus, there is nematode netomopatogen which also attack insect. Both are safe for the environment, because it does not cause environmental pollution and does not cause resistance to insect pests (Hajek & Delalibera, 2010; Divya & Sankar, 2009).

*Correspondence Address
E-mail: dyahrini36@gmail.com

The semi-field study was conducted in Jepara to analyze the effect of MET, NEP and the mixture of both substances on the *O. rhinoceros* larval mortality. The treatment was conducted in coconut plantation owned by the local people using pots containing soil medium with organic material. The results showed that controlling *O. rhinoceros* larvae with the mixture of MET and NEP resulted in faster larval mortality (2-5 weeks) than the treatment with the MET (2-7 weeks) or the NEP (2-8 weeks), while larval mortality without the administration of MET or NEP (control) was 13-20%, the larvae that remained alive was 80-87% (Indriyanti et al., 2017). Ecological research has never been done in Jepara, therefore it is necessary to do.

The MET and NEP applications on a semi-field scale have been proven effective in controlling the *O. rhinoceros* larvae. However, the results of the application of MET and NEP in a field have not been reported yet. The biological control of *O. rhinoceros* larvae with parasitic fungus (MET) and (NEP) offers environmentally friendly pest controls without the emerge of pest resistance. Therefore, it is necessary to conduct a research for the purpose of analyzing the effect of MET and NEP application for controlling *O. rhinoceros* larvae on a field scale.

METHODS

This study was conducted in Jerukwangi, Jepara, Indonesia. This study used Randomized Block Design with three types of treatment (MET, NEP, and the mixture of MET and NEP). The population in this study was all *O. rhinoceros* larvae in Jerukwangi Village. The samples in this study were 330 *O. rhinoceros* larvae (3rd instar) obtained from nests in the field. The larvae were collected by digging the suspected place. The places where larva often encounters were in the piles of cattle dung (cows and goats), the livestock fodder, garbage piles, and rotted coconut trunks. The recorded abiotic factors were temperature, air humidity, soil pH, soil moisture, and light intensity. 100 grams of soil was taken to check the soil moisture content.

The Application of *M. Anisopliae* (MET)

The MET used was in the form of conidia with kaolin powder formulation (ZIUM ORWP) obtained from BPTBUN Salatiga. The conidial density was 2.50×10^8 conidia L⁻¹, with the viability of 93%. Treatment places were in the same places where the larvae were found, which were then called nests. The size of the nest was 1 x 1 x

0.3 m. 100 grams of MET was added to the soil (in the nest) and then stirred in depth of 0.3 m. 10 larvae were placed in the nest. The location was covered by a net (hole size of 3x3 mm) and then be marked. This closure aimed to avoid the interference from the outside. The MET treatment was repeated 10 times. For comparison (control), the same procedure was applied in the other nest without the administration of MET. Data collection was conducted once a week for 6 weeks by counting the MET-infected larvae.

The Application of Entomopathogenic Nematodes (NEP)

The nematodes used were *Heterorhabditis* sp obtained from the Plant Pest and Disease Department, Faculty of Agriculture, Jember. The nematodes formulation was in the form of liquid with sponge media containing 10×10^6 NEP per pack. The recommended dosage of NEP is one plastic package for 1 spray tank (14 liters) for 500 m². Based on the preliminary research, the dose of dilution for application in the field scale was needed to be improved, so that the dilution used was 3.5 liters for one package. The application of the nematodes was conducted by spraying the NEP solution to the nest (soil) with the size of 1 x 1 x 0.3 m. Ten larvae were then placed in the nest. As a control, water was splashed to the ground to replace the NEP solution. The NEP treatment was repeated 10 times with one control. Both treatment and control nest were covered by a net and then marked. Data collection was conducted once a week for 6 weeks.

The Application of the Mixture of MET and NEP

The same procedure as the MET and NEP treatments were applied in this treatment. The dosage used was 100 grams of MET combined with 1 pack of NEP in 3.5 liters of water, while for comparison, the control nest was administered only by the water (without MET and NEP). The treatment was repeated 10 times with one control. Both treatment and control nest (1 x 1m) were covered by a net and then marked. Observations were conducted once a week. The nest was dismantled and the characteristics or symptoms of infected larvae were then observed. The observations were performed until all the larvae in the nest died. The dead larvae were observed in the Biology Laboratory of Universitas Negeri Semarang to ascertain that the death of larvae was caused by the infection of MET or NEP. Data collection was conducted once a week for six weeks.

RESULTS AND DISCUSSION

The Application of *M. anisopliae* (MET)

The results of observation showed that MET-infected larvae were initially characterized by the appearance of dark brown necrotic spots at the location of the hyphae penetration on the body of larvae. In addition, the larvae showed behavioral changes in form of laziness, slow motion, loss of coordination ability, decreased in feeding activity and the change in color (from white into dull). According to Gusmara (2011), the dark brown necrotic spots are a sign of melanization that indicates a fungal infection occurs in the larvae. Melanization is a form of self-defense against fungal infections that serve to inhibit the growth of fungi in the body of the larvae. The dark brown necrotic spots are melanin produced by phenol compounds catalyzed by phenol oxidase enzymes.

The MET-infected dead Larvae were characterized by a hardened body (mummification) and the growth of fungus MET on the entire body of larvae. The color of hyphae changed from white to green along with the increasing age. According to Jackson & Jaronski (2009), mummification occurs in the larval body because all tissues and body fluids of larvae used up for the proliferation of MET. The observation results on larval infection symptom are presented in Figure 1.

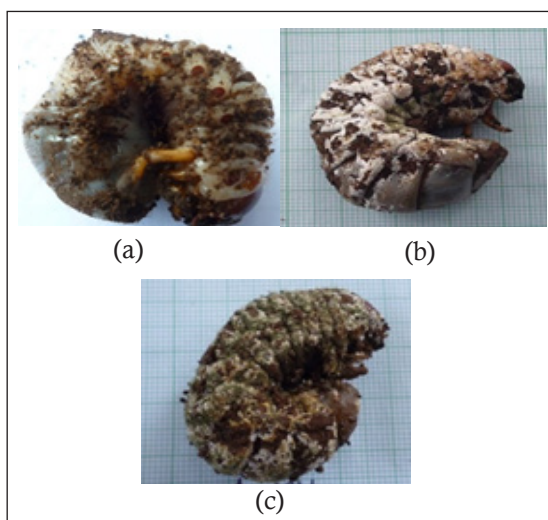


Figure 1. The Symptom of MET Infection on *O. rhinoceros* larva. (a) Dark Brown Necrotic Spot; (b) White MET Hyphae; and (c) MET Hyphae that Turned into Dark Green. The Hardened Body of the Larva.

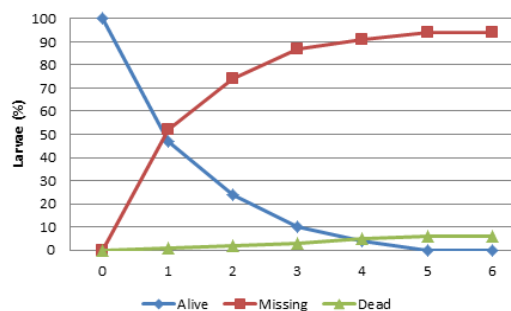


Figure 2. The Percentage of Alive, Missing and MET-Infected Dead Larvae of *O. rhinoceros* with the treatment Using 100gr/m² MET on 6 Weeks of Treatment Period.

Based on Figure 2, it is known that MET application on *O. rhinoceros* nest resulted in many missing larvae. The larvae were not found at the observation site (nest). Larval control effort on the nest could only kill 6% of the larval population. The missing larva is an interesting phenomenon, which has not occurred in the previous study (treatment with the pots). In the previous study, the MET-infected larval mortality can reach 100% in the 7th week (Latifian & Rad, 2012). This might happen because the larvae were isolated in pots. In the field, the result was very different because the larvae can easily and freely move away from the treated place.

The larval mortality rate as a result of MET treatment only reached 6% until the last day of observation (Figure 2). This was related to the many-disappeared larvae from the treated nest. The death of larvae was caused by the fungal infection. According to Bedford (2013), the larval stages of *O. rhinoceros* actively looked for substrates that contained lots of organic material as a source of food. Larvae moved out of the treated nest because the source of organic materials used to feed was finished and they looked for a source of more abundant organic material outside the nest.

Some of the missing larvae were found around the nest. They were still alive and some of them were going into the soil deeper. Larvae turned active, looking for food that has not been eaten. This resembles the cultivation of earthworms. When the dirt has been eaten, the worm moves to another place around the media. The larvae move away horizontally from the nest because they want to get food around it. The larvae also moved vertically to avoid the light. The movement of larvae into the soil was reported by

Pujiastuti (2010) who found that most urethral larvae were at a depth of more than 30 cm, followed by a depth of 20 cm, and 10 cm.

The results of this study showed that the speed of MET infection was not comparable with the active movement of the larvae. The fungal conidia took at least 18 hours to germinate (viability), then stick to the skin, infect and breed in the body of larvae. It took at least two days for the MET to infect the larvae. This was in accordance with previous research found that the larvae take 2-7 weeks to die. Therefore, controlling the 3rd instar larvae of *O. rhinoceros* in the nest was ineffective. The larvae tended to move actively to avoid the passive mushrooms in the nest. In addition, the 3rd instar larvae have a thick cuticle, so, the MET required a longer time to cause an infection.

The larval mortality is influenced by the pathogenicity of MET conidia. The pathogenicity is determined by the number of conidia that are able to germinate (viability). The higher the viability of conidia, the higher pathogenicity they have. The high viability of MET conidia is influenced by environmental factors. According to Moslim et al. (2011), conidia viability is strongly influenced by environmental factors such as temperature, pH, moisture and water content of the media. The temperature in the Jerukwangi Village was 30-33°C. According to Pracaya (2004), the ideal temperature for the growth of MET ranges from 22-27°C. The presence of dead larvae infected by MET proved that the temperature ranging from 30-33°C is still possible for the growth of MET. The soil pH in the study site ranged from 6.7 to 7, which was a proper pH for the growth of the MET. The soil pH at the time of MET application was very important because it was related to the work of MET enzymes. According to Paula et al. (2011), an appropriate pH for the growth of MET ranges from 3.3-8.5 and optimum growth occurs at pH 7. The air humidity in this study ranged from 68-87%. It was suspected to be the cause of low MET infection rate. Jackson & Jaronski (2009) reported that the pathogenicity of the MET decreased when the air humidity was below 86%. The intensity of light in this study ranged from 360-860 Lux because the location of the treated nest was in a place shaded by trees, so it was not too exposed to sunlight.

The MET-treated nest would be effective for early instar larvae. It would be more effective when the MET initially applied in the nest and the female put the eggs in that nest, then the eggs hatched releasing the 1st instar larvae. Those larvae would be easily infected because their

skin is relatively soft and they are not yet actively moving. Therefore, for the MET-treatment of the 3rd instar larvae, they should be placed in a particular container. After the larvae were infected and died, then they could be made into an inoculum at the nest site.

The Application of Entomopathogenic Nematodes (NEP)

The observation on larvae infected by NEP showed changes in larval body color from clean white to brownish-black and the texture of the larval body became mushy. These results are in accordance with the statement of Sucipto (2008) that the symptoms of NEP attack on host insects are characterized by changes in the color of the body surface to dark brown. The body also became soft and so the tissue became aqueous. Changes in body color of *O. rhinoceros* larvae were due to the bacterial reaction of the *Photorhabdus* sp symbionts in the digestive tract of nematodes. The enzymatic activity of *Photorhabdus* sp bacteria caused the destruction of the larval tissue resulting in black dead larvae (Suyanto et al., 2012). Figure 3 shows the *O. rhinoceros* larvae infected by NEP.



Figure 3. *O. rhinoceros* Larva Infected by *Heterorhabditis* sp Entomopathogenic Nematodes (NEP).

The result of observation on the application of NEP on *O. rhinoceros* larval nest for 6 weeks is presented in Figure 4.

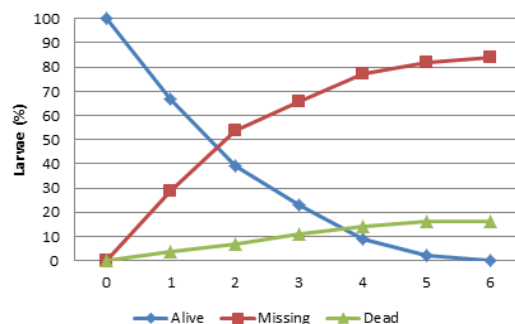


Figure 4. The Percentage of alive, missing and NEP-infected dead larvae of *O. rhinoceros* with the treatment using 3.5 liters dilution of NEP on 6 weeks of treatment period.

Figure 4 shows the same symptom as in the application of MET (Figure 2). The loss of larvae was assumed to be related to the food availability. The larvae were commonly found on the outside of the nest moving toward the new food sources. The percentage of larval mortality showed an increase in the 1st week (4%) to the 6th week (16%). The results were different compared with the previous study which used pots resulting in 100% the larval mortality on the 8th week (Latifian & Rad, 2012).

The results of this study indicated that speed of NEP in infecting the larvae was not comparable to the speed of larval move avoiding the NEP. The NEP needed time to find the natural holes in the body of the larvae, enter the body, and then infect the larvae. The NEP-infected larvae were those that did not move away from the location. Therefore, the addition of NEP to the nest could only control 16% of the larval population. The nematodes have a killing effect on their host because NEP is symbiotic with NEP-induced bacteria. According to Noguez et al. (2012), the NEP of the *Heterorhabditidae* family is symbiotic with the *Photorhabdus* sp. bacterium. The symbiotic bacteria coming out of the NEP after the penetration into the larval body release a toxin causing the *O. rhinoceros* larvae to die (Kaya, 1993).

The nematode's killing ability is not only determined by the symbiosis between the NEP and the symbiotic bacteria but also the self-defense of *O. rhinoceros* larvae. In this study, the larval movement away from the nest was an effort to defend them from being infected with NEP. Environmental conditions such as temperature, sunlight intensity, humidity, and the rainfall influenced the NEP activity in the soil. Temperature measurements in the study ranged from 30-33°C, which was still possible for NEP activity. It was evidenced by the presence of dead larvae infected by the NEP. According to Adam & Nguyen (2002), nematodes could increase their activity by 80% at a temperature of 21-30°C and decreased at a temperature of 12-16°C. The soil moisture ranged during the study was 49-70%. According to Suyanto et al. (2012), moisture was the most important thing that affected the activity of NEP in the soil. An appropriate soil moisture ranged from 40-90%.

The NEP applications in the field were conducted in April-June with high rainfall ranging from 100-200 mm (Weather & Climate

2016). The continuous intensity of rainfall allowed the NEP carried by the rain. According to Manan & Suyanto (2009), not all NEP could enter the body of the larvae, this was due to the environmental factors such as excessive rainfall that could wash away the NEP. Therefore, the rainfall was the main factor of the low probability of NEP penetration to the body of the larvae.

The Application of the Mixture of *M. anisopliae* (MET) and Entomopathogenic Nematodes (NEP)

The observation results showed variety symptoms of larval death, among which the larvae were infected by the MET (Figure 1), the NEP (Figure 3), and the mixture of MET and NEP in a single larval body. The larvae infected by the mixture of MET and NEP showed a symptom in form of the hyphae growth on the entire larval body except for the abdomen. The texture of the body hardened on the part where the hyphae grew, while the abdomen was mushy with the appearance of blackish brown color. According to Jackson & Jaronski (2009), the occurrence of hardening (mummification) in the body of *O. rhinoceros* larvae was due to the tissue and body fluids of larvae which have been used up by the MET. The abdominal portion of *O. rhinoceros* larvae was suspected to be infected with the NEP. It was in accordance with the statement of Afifah et al. (2013) and Latifian & Rad (2012) that the symptoms of insects infected by the NEP are marked by a change of color, the body becomes tender because the tissue in the body becomes liquid. The appearance of larvae infected with MET and NEP is presented in Figure 5.



Figure 5. *O. rhinoceros* larvae infected by the mixture of MET and NEP. (a) part of the body that is infected by MET; and (b) part of the body that is infected by NEP

The observation results on the application of MET and NEP mixture on *O. rhinoceros* larval nest for 6 weeks appear in Figure 6.

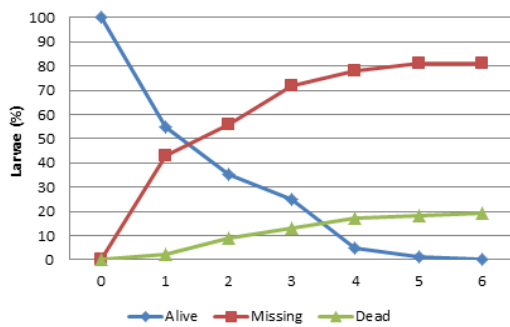


Figure 6. The Percentage of Alive, Missing and MET-infected Dead Larvae of *O. rhinoceros* with the Treatment Using the Mixture of 100 g/m² of MET and 3.5 Liters Dilution of NEP on 6 Weeks of Treatment Period.

Figure 6. shows almost the same results as the treatment using the MET (Figure 2) and NEP (Figure 4). Many larvae are not found in the observed nest. However, the dead larvae found in this treatment (19%) are more than the ones found on the treatment using only MET (6%) or only NEP (16%) (Figure 7). In percentage, there was an increase in the number of dead larvae. The mechanism suspected underlying the synergy between MET and NEP was that the MET or NEP-infected larvae condition would be weaker and more susceptible to the subsequent infections. This is consistent with the study by Ansari et al. (2008) showed that the MET-infected larvae will be weaker and vulnerable to the infection of NEP infection. This fact corresponded to the decrease in larval activity resulted in a higher probability of NEP infection.

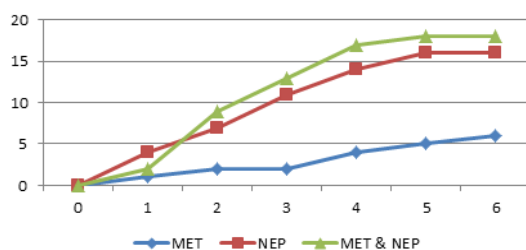


Figure 7. The Percentage of *O. rhinoceros* Dead Larvae with the Treatment Using the MET, NEP and MET + NEP on 6 Weeks of Treatment Period.

Mixing the MET and NEP in this study was expected to accelerate the process of infection so that the process of controlling *O. rhinoceros* would be accelerated too. However, the results showed that economically the mixture of MET and NEP was not favorable because of a small difference in larval mortality (3-13%). Therefore,

it was suggested to choose only one kind of substances. In this treatment, many larvae indicated the symptoms of MET and NEP infection, but the most found were the NEP symptoms (mushy larval body). The results of the field test were very different compared with the semi-field test using pots, in which the larval mortality reached 100% at the 5th week. The research benefit was the recommendation of *O. rhinoceros* larvae control in the field.

CONCLUSION

The results of MET, NEP, and the mixture of MET and NEP application on *O. rhinoceros* larvae in the field showed that there were many larvae missing from the nest and moving both horizontally and vertically. The larval mortality as a result of the application of MET, NEP, and the mixture of MET and NEP on the 6th week are 6%, 16%, and 19% respectively. The control using two biological agents (MET and NEP) was better than the MET or NEP only.

REFERENCES

- Adams. B.J & Nguyen, K.B. (2002). Taxonomy and Systematics. Pp 1-28 in: R. Gaugler (Ed). *Entomopathogenic Nematology*. CAB International, Wallingford, Oxford.
- Affiah, L., Rahardjo, B. T., & Tarno, H. (2013). Eksplorasi Nematoda Entomopatogen pada Lahan Tanaman Jagung, Kedelai dan Kubis di Malang Serta Virulensinya terhadap *Spodoptera litura fabricius*. *Jurnal Hama dan Penyakit Tumbuhan*, 1(2), 1-9.
- Agali, A.E.A., Mohammed, E.A.E.R., Hassan, A.E.W. (2017). Effect of Entomopathogenic Fungi *Metarhizium anisopliae* var *acidum* and *Beauveria bassiana* on Survival of *Anopheles arabiensis* Patton and *Culex quinquefasciatus* Say Mosquito Larvae. *Sudan Journal of Science*, 9(2), 26-40.
- Amalia, A.V & Yusa, M.H. (2018). Control Pest of Leaf Caterpillars (*Plutella xylostella*) in Delima Rose Apples Using Soursop Leaf Extract (*Annona muricata*). *Jurnal Pendidikan IPA Indonesia*. 7(1), 1-8.
- Ansari, M.A., Shah, F.A. & Butt T.M. (2008). Combined Use of Entomopathogenic Nematodes and *Metarhizium anisopliae* as a New Approach for Black Vine Weevil, *Otiiorhynchus sulcatus*, Control. *Entomologia Experimentalis et Applicata*, 129(3), 340-347.
- Bedford, G. O. (2013). Long-term Reduction in Damage by Rhinoceros Beetle *Oryctes rhinoceros* (L.) (Coleoptera: Scarabaeidae: Dynastinae) to Coconut palm at *Oryctes Nudivirus* release Site on Viti Levu, Fiji. *African Journal of Agricultural*

- Research*, 8(49), 6422-6425.
- Divya, K., & Sankar, M. (2009). Entomopathogenic Nematodes in Pest Management. *Indian Journal of Science and Technology*, 2(7), 53-60.
- Gusmara, B.H. (2011). Pembuatan dan Pengujian Formula *Metarhizium majus* UICC 295 dengan Media Pembawa Substrat Beras (*Oryza sativa*) terhadap Larva *Oryctes rhinoceros*. (Skripsi). Depok: Universitas Indonesia.
- Hajek, A. E., & Delalibera, I. (2010). Fungal Pathogens as Classical Biological Control Agents against Arthropods. *BioControl*, 55(1), 147-158.
- Indriyanti, D. R., Lutfiana, J. E., Widiyaningrum, P., Susilowati, E., & Slamet, M. (2018, March). Aggregation Pheromones for Monitoring the Coconut Rhinoceros Beetle (*Oryctes rhinoceros*) in Jerukwangi Village, Jepara, Indonesia. In *Journal of Physics: Conference Series* (Vol. 983, No. 1, p. 012177). IOP Publishing.
- Indriyanti, D.R., Widiyaningrum, P., Haryuni, Slamet, M. & Mareta, Y.A. (2017). Effectiveness of *Metarhizium anisopliae* and Entomopathogenic Nematodes to Control *Oryctes rhinoceros* Larvae in the Rainy Season. *Pakistan Journal of Biological Sciences*, 20(7), 320-327.
- Jackson, M. A., & Jaronski, S. T. (2009). Production of Microsclerotia of the Fungal Entomopathogen *Metarhizium anisopliae* and Their Potential for Use as a Biocontrol Agent for Soil-Inhabiting Insects. *Mycological Research*, 113(8), 842-850.
- Jackson, T. A. (2009). The Use of *Oryctes* Virus for Control of Rhinoceros Beetle in the Pacific Islands. In *Use of Microbes for Control and Eradication of Invasive Arthropods* (pp. 133-140). Springer, Dordrecht.
- Kaya, M.G. (1993). Efficacy Against Soil-Inhabiting Insect Pests. In: Gauler Kaya H K. (Ed) *Entomopathogenic Nematodes in Biological Control*. Florida: CRC Press.
- Khudhair, M.W., Khalaf, M.Z., Alrubeai, H.F., Shbar, A.K., Hamad, B.S., Khalaf H.S. 2015. Evaluating the Virulence of *Metarhizium anisopliae* (Deuteromycotina: Hyphomycetes) and *Beauveria bassiana* (Ascomycota: Hypocreales) isolates to Arabian rhinoceros beetle, *Oryctes agamemnon arabicus*. *Journal of Entomological and Acarological Research*, 47(3), 117-122.
- Latifian, M., & Rad, B. (2012). Pathogenicity of the Entomopathogenic Fungi *Beauveria bassiana* (Balsamo) Vuillmin, *Beauveria brongniartii* Saccardo and *Metarhizium anisopliae* Metsch to Adult *Oryctes elegans* Prell and Effects on Feeding and Fecundity. *International Journal of Agriculture and Crop Sciences*, 4(14), 1026-1032.
- Manan, A & Suyanto, A. (2009). Kemempnan Isolat Lokal Nematoda Entomopatogen *Steinernema carpocapsae* Poinar Untuk Pengendalian Hama Ulat Grayak (*Spodoptera litura* F.). *Jurnal Pembangunan Pedesaan*, 9(1), 35-42.
- Manjeri G, Muhamad, R & Tan, S.G. (2014). *Oryctes rhinoceros* Beetles, an Oil Palm Pest in Malaysia. *Annual Research & Review in Biology*, 4(22), 3429-3439.
- Moslim, R. A. M. L. E., Kamarudin, N., & Wahid, M. B. (2011). Trap For the Auto Dissemination of *Metarhizium Anisopliae* in the Management of Rhinoceros Beetle, *Oryctes Rhinoceros*. *J. Oil Palm Res*, 23, 1011-1017.
- Noguez, J. H., Conner, E. S., Zhou, Y., Ciche, T. A., Ragains, J. R., & Butcher, R. A. (2012). A Novel Ascaroside Controls the Parasitic Life Cycle of the Entomopathogenic Nematode *Heterorhabditis Bacteriophora*. *ACS chemical biology*, 7(6), 961-966.
- Paula, A. R., Carolino, A. T., Paula, C. O., & Samuels, R. I. (2011). The Combination of the Entomopathogenic Fungus *Metarhizium anisopliae* with the Insecticide Imidacloprid Increases Virulence against the Dengue Vector *Aedes aegypti* (Diptera: Culicidae). *Parasites & vectors*, 4(1), 8.
- Pracaya. 2004. *Hama Penyakit Tanaman*. Depok: Penerbit Swadaya.
- Pujiastuti, Y. (2010). Tingkat Populasi dan Kebugaran *Oryctes rhinoceros* L Coleoptera: Scarabaeidae di Perkebunan Kelapa Sawit (*Elaeis Guineensis* Jacq). *Prosiding Seminar Nasional Penelitian Bidang Pertanian*. Vol 2.
- Sucipto. (2008.) Persistensi Nematoda Entomopatogen *Heterorhabditis* (All Strain) Isolate Lokal Madura terhadap Pengendalian Rayap Tanah *Macrotermes* sp. (Isoptera: Termitidae) di lapangan. *Jurnal Embryo*, 5(2), 193-208.
- Suyanto, A., Srimurni, E & Djuharyanto, T. (2012). Perkembangan Larva Serangga Hama Kumbang Badak (*Oryctes rhinoceros* L.) pada Berbagai Konsentrasi Isolat Nematoda Entomopatogen *Heterorhabditis* sp. *Prosiding Seminar Nasional* ISBN: 978-979-9204-79-0; Purwokerto.
- Weather and climate. (2016). Average, Monthly, Precipitation, Rainfall Jepara Central Java. Retrieved from <https://weather-and-climate.com/average-monthly-precipitation-Rainfalljepara-central-java-id,Indonesia>



CHANGES IN PROSPECTIVE BIOLOGY TEACHERS' MENTAL MODEL OF VIRUS THROUGH DRAWING-WRITING TEST: AN APPLICATION OF MENTAL MODEL-BASED MICROBIOLOGY COURSE

Y. Hamdiyati^{*1,5}, F. Sudargo^{2,5}, A. Fitriani^{3,5}, A. Rachmatullah⁴

^{1,2,3}Biology Education Department, Universitas Pendidikan Indonesia (UPI), Indonesia

⁴Departement of STEM Education, College of Education, North Carolina State University, Raleigh, NC, USA

⁵Graduate School of Science Education, Universitas Pendidikan Indonesia (UPI), Indonesia

DOI: 10.15294/jpii.v7i3.14280

Accepted: May 22nd, 2018. Approved: August 31st, 2018. Published: September 20th, 2018

ABSTRACT

The main goal of the present research was to analyze the prospective biology teachers' mental model about virus through the conduction of drawing-writing test on a modified model-based learning in a Microbiology course. The research method was quasi-experiment with pretest-posttest control group design. A total of eighty-one fifth-semester students separated into experiment and control group participated in the current study. The experiment class participated in a microbiology course-based mental model, in which the course program was developed by combining the constructivism learning stages and model-based learning framework featured with mental model, while the control class experienced course with conventional methods. A mental model test of drawing-writing of structure of viruses was employed as the main research instrument. The instrument also was featured with a rubric that is used to indicate the five levels of student's mental model. The main analysis was done through descriptive interpretation based on the frequency of higher levels of mental model showed by students in the different classes. Based on the results, there was no difference between students in experiment and control class in the pretest, which showed that most of the students in both class were concentrated in not higher than level D3 and W3 (partially correct drawing/writing). However, after an intervention, the experiment class showed a dramatically increase in the frequency of students mental model that belong to level D5/W5 (completely correct and complete drawing/writing), while the control group was found stagnant concentrated in the level D3/W3. The results are discussed with the connection to the advantages of Microbiology course-based mental model in student's conceptual change and the use of drawing-writing test in capturing changes in student's mental model about scientific concepts.

© 2018 Science Education Study Program FMIPA UNNES Semarang

Keywords: mental models, drawing-writing test, virus, biology education program, microbiology course

INTRODUCTION

Microbes or microorganisms are known as the central part of microbiology course in the higher education level, both biology and biology education program. The importance of the study of microorganisms comes from the nature

of microorganisms itself in which abundance in number, living in broad range of areas, and highly related to human's daily life (Tortora et al., 2009). To the extent, scientists have also considered that microbiology has a tight connection with other significant disciplines, such as modern biotechnology, genetic engineering and bioprocess, evolution, and molecular biology (Schaechter et al., 2004). By considering the issue of the nature of

*Correspondence Address
E-mail: yhamdiyati@upi.edu

microorganisms and microbiology in which it is related to human's life and the development of other related-disciplines, biology education scholars contend that understanding microorganism is necessary for biology students (Kelwick et al., 2015) and even more crucial for prospective biology teachers, given they will deliver their understanding to the students. Prospective teachers with sufficient and scientific understanding about microorganisms can prevent them to teach alternative conceptions to students (Quilin & Thomas, 2015), as what Smith et al. (2008) stated that most of the misconceptions that in-service teachers have are originated from their undergraduate life.

In the past decade, many have been scrutinizing whether prospective biology teachers have sufficient understanding about microorganisms or not (e.g. Kurt, 2013). In addition, some even have been exploring whether prospective biology teachers, primary and secondary students and in-service teachers have misconceptions or alternative conceptions about microorganisms or not (e.g. Byrne, 2011; Jee et al., 2013). However, most of previous studies have found that prospective biology teachers, and in-service biology teachers still do not have sufficient knowledge of microorganisms and have misconceptions about microorganisms. The misconceptions or alternative conceptions found in the previous studies are due to the students' inability to connect a concept with another existing in their mind (Kurt et al., 2013). These conceptions and alternative misconceptions are undesirable in the learning process since learners will draw up wrong conclusions and will negatively affect the process their new knowledge construction. Buckley and Boulter (2000) suggested the use of mental-model in order to detect students' conceptions about scientific concepts and the interconnection between concepts within a scope of particular discipline. Thus, in the current study we attempt to use the concept of mental model in detecting prospective biology teacher's conceptions of microorganisms and the interconnection between concepts within microbiology scope.

Scholars have been defining the meaning of mental model. However, they have similarities in the key concept of the meaning of mental model. One noted definition of mental model was defined by Buckley and Boulter (2000). They define mental model as a depiction, personal ideas, or an individual's internal representation of a phenomenon, a collection of ideas or concepts. Buckley and Boulter (2000) added that mental model could give an indication of what one un-

derstands about a concept at a certain point and time, as well as their knowledge and belief in the concept. In addition, Norman (2014) described mental models as internal representations built by a person to provide a rational explanation of the phenomenon of experience. Coll (2009) argued that mental model is used to produce simpler concepts, providing support for simulation and visualization, also, provide explanations for scientific phenomena. However, Stains and Sevian (2014) revealed that knowing one's mental model is something that is difficult to do if it is not expressed in the form of concrete things. Therefore, Buckley and Boulter (2000) emphasized the necessity of expressed mental models through various means, through a drawing-writing test, for instance. Analyzing the expressed model can provide a perception of a person's conceptualization of events, phenomena, or concepts. Thus, information about one's knowledge about and understanding of the concept can be obtained.

In regards to the discussion on the relationship between the expressed model, the mental model, and the person's perception of the phenomenon, it is an iterative relation. The expressed model can provide an insight into one's mental model, but along with the additional experience gained through both direct and indirect learning, the perception of a phenomenon will change, resulting in different outcomes of the mental model, and end up with a different expressed mental model (Byrne, 2011). The mental model is expressed through an individual interpretation which can be based on interaction with the environment, individual memory, individual learning diagram results, or information on the article (Saptono et al., 2017). Students will experience mental model changes gradually because of the influence of the obtained information. The mental models of students tend to be unstable, inconsistent, and ever-changing as more information is acquired or recalled (Khasanah et al., 2016). Research has shown that students' mental model of phenomena or scientific entities is limited by the students' assumptions about the entities and processes existing in the phenomenon or entity (Stains & Sevian, 2014).

Recalling back the discussion about the understanding of microorganisms, in which a part of it is the understanding of viruses, previous studies showed that mental model about viruses in non-expert groups (students and teachers) had a complex but scientifically incorrect mental model compared to expert groups (Jee et al., 2013). A study by Jee et al. (2013) on future Biology teachers in Turkey already found that they had some

knowledge about some microbial concepts, but there still existed misconceptions. They mostly wrote the definition of a virus to answer the question of virus concept, also, misconceptions were still there (Kurt, 2013, Kurt & Ekici, 2013). Several studies have shown that students often had an inaccurate concept of structure of a virus and function (Jones et al., 2013).

The previous studies show that drawing techniques are most often used to reveal participants' conceptual structures about microbial concepts. The drawing an illustration is one of the oldest methods to record the data. The same techniques were also employed in a research conducted by Dikmenli (2010) investigated biology student teachers' misconceptions of cell divisions using drawings and interviews. An analysis of drawings and interviews suggested that biology student teachers have a series of significant problems and misconceptions regarding cell division and structuring of concepts in a meaningful manner. The research results of Hamdiyati et al. (2017) on Biology students' early mental models show that the level of mental models through drawing and writing on the four concepts vary greatly. The highest level of the mental model through the drawing test (D5) was found in the concept of bacteria, while the highest level of the mental model through writing test (W3) was found in the concept of bacteria, viruses, and fungi. Therefore, it can be said that picture is the right tool to use in determining the image/description, mental model, conceptualization, misconception, knowledge, and ideas of students (Oren & Ormanci, 2014).

New ideas are assimilated into an existing or accommodated scheme by creating a new one. This may lead to cognitive discrepancies if, for instance, new ideas are scientifically accurate but inconsistent with the schemes owned by students, while rejection of new ideas is also possible. When new ideas are accepted and linked to the existing ideas, learning processes will enlarge and improve the students' mental models, though this definitely takes time (Núñez-Oveido et al., 2008; Byrne, 2011).

Changes in the complexity of a person's mental model can be analyzed/facilitated through a particular learning model. In this study, the researchers modified a typical microbiology course by focusing it more on the mental model and using drawing-writing test assessment as one way to externalize an individual's mental model, so as to provide an overview of the mental model development before and after the course program on the virus subject. In addition,

future Biology teachers must understand the basic concepts of Biology and have a great responsibility of their future students' understanding of the conceptual structure of biological concepts, including the concept of structure of a virus. Having appropriate microbiology lessons for the 21st-century curriculum will help students understand and appreciate the importance of microorganisms in everyday life so that they can make informed decisions now and then (Byrne, 2011).

Overall, the purpose this study was to determine the improvement of student's mental model through drawing-writing test in a modified Microbiology course. However, research on how to analyze the change mental models of the students about virus used specific learning strategies has never been done previously.

METHODS

The method of the present research adopted quasi-experiment method with pretest-posttest control group design. One class as the experiment class was the class using microbiology course-based mental model and on the other hand the control class used the conventional methods (discussion, lecture, and questions-answers). The sample in this research included 2 classes, 39 students of the experimental class and 42 students of the control class. Both classes consisted of 5th-semester students of Biology Education program at a public university in West Java, Indonesia. The data of both classes were collected before and after the students join the lectures. The subject of the virus was limited to viral structural materials. The students were asked to describe their imagination about the structure of the virus and explain the structure in writing through open-ended questions.

In the experimental class, the students were divided into 13 small group consisting 2-3 students each. This modified microbiological learning has several stages (syntax). The course program was developed by combining the constructivism learning stages according to Duit et al. (2007) and model-based learning framework by Rea-Ramirez et al. (2008). The class was began with the exploration of students' pre-conceptions in order to find out how deep the students' knowledge about microorganism concepts is. Next, restructuring of the concept was conducted. At this stage, the students were led to achieve a target mental model or accomplish a higher level mental model through guided questions on student activity sheet. Following stage, the students were asked to apply the new acquired

concept into daily life situation. This modified microbiological learning ended up with reviewing and evaluating the new ideas whether they fit or not with the targeted mental model. Through these learning stages, the students can improve their mental model of the structure of a virus so as to achieve the target mental model according to the experts' mental models. The illustrations of the course are provided in Table 1. The mental model levels were drawn

up from an implementation of drawing-writing test. Students' answers were categorized based on the indicators mentioned in the Table 2, also every indicator is assigned to the specific level of students' mental model. The results of the present study were represented in the form of tables and graphs. Besides, it is also described with some examples of students' answers representing each level of the mental model, both drawing and writing.

Table 1. The Syntaxes of Microbiology Course-Based Mental Model on Virus Topic (Excerpts of the 1st Sub-topic among 7 Sub-topics)

Lecture Stages	Lecturer's Activities	Students' Activities
Analyzing the learning sources	Providing suggestions of the microbiology textbooks used before the lecture begins. Providing learning media	Providing the textbooks as suggested by the lecture
Assignment	Assigning the students to make concept maps (at home) before the lecture. Checking the maps created by the students via email.	Providing the textbooks as suggested by the lecture
Learning Stages (Syntax) of Lectures		
Introduction	Preparing the students to be ready and interested in joining the lectures Explaining the objectives of the lectures	Showing the readiness and interest in joining the lecture
Preconceptional exploration and Students' conception exploration of the 1st sub-topic (general structure of the virus)	Facilitating the students to explain the outline of the topic as they know Guiding the student to decide essential concepts of the general structure of virus sub-topic	Stating initial knowledge about the topic (virus) classically. Stating essential concepts of the general structure of virus sub-topic classically.
Restructuring the concepts	Reminding the students to use basic source microbiology textbooks that have been specified in the lesson to restructure the concepts. Asking referring questions to restructure the concepts. Encouraging the students to achieve early mental model changes to M1, M2 ... Mn in accomplishing the target mental model.	Using basic source microbiology textbooks that have been specified in the lesson to restructure the concepts. Being able to restructure the concepts under the lecturer's guidance through the referring questions. Showing the changes of the early mental model to M1, M2...Mn in accomplishing the target mental model.
Applying new concepts	Encouraging the students to apply new ideas constructed to other contexts or real-life/everyday context through application questions.	Informing the examples of applications of new concepts constructed in real-life/daily life.
Reviewing and evaluating new ideas	Reviewing the target mental model according to the experts' mental model on the general structure of the virus	Listening to lecturer's explanation of the target mental model according to experts on the general structure of the virus

Table 2. Mental Model Categories for Drawing-Writing Test Results

Level	Statement	Drawing	Writing
Level 1	There is no drawing/writing	D1	W1
Level 2	Wrong or irrelevant drawing/writing	D2	W2
Level 3	Partially correct drawing/writing	D3	W3
Level 4	The drawing/writing had some mistakes	D4	W4
Level 5	Thoroughly correct and complete drawing/writing	D5	W5

(Modified from Yayla & Eyceyurt, 2011)

RESULTS AND DISCUSSION

The future Biology teachers' mental models of the structure of a virus through the application of mental model on microbiological learning and through the use of drawing-writing test assessment can be seen in Table 3 and Table 4. Figure 1 and 2 show the changes of drawing and writing levels based on pre and post-test result both in experimental and control groups. Figure 3 is an example of the structure of a virus drawing test results at level 2, 3, 4, and 5.

According to Table 3, the pretest results on the highest level of the experimental class' mental model level were at D2 / W2 and D3 / W3, respectively 10 people each. The highest level achieved in the experimental group was only at D3 / W4, while the lowest level was at D1 / W1. In the control group, the highest mental model level was found in D3 / W2 (13 people). The highest level accomplished in the control group was only at D4 / W3, while the lowest level was at D2 / W1.

Based on the pre-test results, it can be said that the prior knowledge about the structure of a virus of the control class was better than experimental class. It is important for a teacher to know his/her students' prior knowledge to determine the best learning strategy. This is in accordance with the statement of Kurnaz & Emen (2013) that early knowledge of students important to be used as consideration in preparing learnings.

Table 4 shows the final test results of the experimental class on the mental model level. There were 10 students achieved D5/W5 and it was recorded as the highest. Meanwhile, the lowest level was at D2 / W2. In the control class, the students' mental model levels were found at D3 / W3 (19 students). The highest level achieved in the control group was D5 / W4 (1 student), while the lowest level was at D2 / W1 (1 student). These results indicated that the implementation of the mental model application in microbiological learning could improve the prospective Biology teachers' mental model levels. The increasing of the mental model levels was due to the assistance was given by the lecturer facilitated by the Students Activity Sheets at each stage/syntax of the lecture, resulting in the reconstruction of the students' knowledge-based their prior knowledge. The increasing levels of the students' mental models indicated improving mastery concepts of the students about structure of a virus. It can be inferred from the results that the future Biology teachers had different abilities in constructing and applying the mental models they have to complement or improve their initial mental models in order to achieve the targeted mental models. The target mental models were consensus mental models and in accordance with the opinions of the experts. This is in line with previous studies, such as study conducted by Albaiti et al. (2016), Coll (2009), and Khasanah et al. (2016), in which explain that the ability to construct and use mental models can influence the conceptualization of learners.

Table 3. Prospective Biology Teacher' Mental Models of Virus Structure (Pretest)

Level	Experimental					Control				
	W1	W2	W3	W4	W5	W1	W2	W3	W4	W5
D1	4	0	0	0	0	0	0	0	0	0
D2	2	10	3	0	0	1	12	5	0	0
D3	2	7	10	1	0	0	12	11	0	0
D4	0	0	0	0	0	0	0	1	0	0
D5	0	0	0	0	0	0	0	0	0	0

D = Drawing, W = Writing

Table 4. Prospective Biology Teachers' Mental Models of Virus Structure (Posttest)

Level	Experimental					Control				
	W1	W2	W3	W4	W5	W1	W2	W3	W4	W5
D1	0	0	0	0	0	0	0	0	0	0
D2	0	3	0	0	0	0	1	1	0	0
D3	0	1	2	5	0	0	14	19	2	0
D4	1	0	3	3	5	0	1	2	0	0
D5	0	0	0	6	10	0	0	1	1	0

D = Drawing, W = Writing

The tendency to increase the level of the mental model through drawing and writing in both groups is clearly seen in Figure 1 and 2. Figure 1 shows prospective Biology teachers' drawing skill. The mental model level of the students through drawing in both study groups tended to increase at the post-test. At the pre-test, there was no one of the experimental class students reached level 5 (completely correct and complete drawing/writing). However, there were 16 prospective Biology teacher who reached the D5 mental model level at the post-test. On the other side, the post-test results show there were only 2 prospective Biology teacher who accomplished D5 mental model level in the control class.

Figure 2 informs the writing skill of the prospective Biology teachers. The mental model level of the students through writing in both study groups tended to increase at the post-test. At the pre-test, there was no one of the experimental class students reached level 5, the same thing happened in the control class. The post-test results were 15 prospective Biology teacher accomplishing D5 mental model level, while there was no single student achieving D5 at the post-test in the control class.

Based on Figures 1 and 2, the pre-test results generally did not differ significantly between the two experimental groups. Paying attention to each level, the experimental class had more D1 and W1 than the control class at the pre-test. However, the post-test results show that the experimental class had a higher mental model level, nearly hit the target. This suggested that the application of mental model on microbiological learning may lead to changes in the learners' mental models through disconfirmation mode, modification mode, confirmation mode, and addition mode. This is in line with Buckley & Boulter (2000) who revealed that the early mental model information of his research results was the model evolution where the exist-

ing prior knowledge along with new information formed a new mental model through model-reinforcement, model-elaboration & revision, or model-rejection.

Each stage (syntax) of the modified model-based microbiological learning facilitated the changes of the students' mental model. The exploration of the students' initial ideas was done during the preconception exploration stage. This is important as the information for lecturers to lead the students hit the target mental models. Lecturers should be ready to facilitate the dynamics of the students' mental model changes either in the low, medium, or high. This is supported by Hamid's (2016) opinion that teachers should be explorative of the students' basic ideas of a concept so that their ideas can be used as a starting point to lead them to the experts' ideas. The mental model is dynamic and sustainable, means that the mental model can be modified if there is new information inserted into the old mental model. This indicates mental model's nature of dynamic and sustainable (Wiji et al., 2014). Implementation of the modified Microbiology course on the subject of bacteria shows a change of mental model level from transitional to close to extended and extended (Hamdiyati et al., 2018).

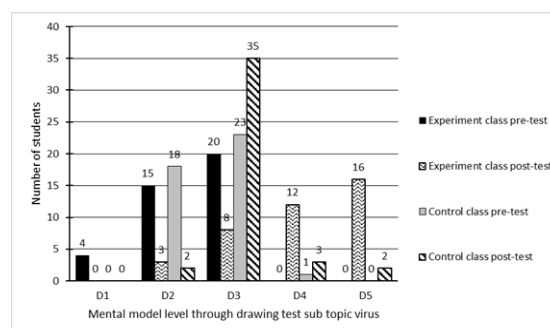


Figure 1. The Mental Model Levels of Prospective Biology Teachers on Structure of a Virus Through Drawing Tests in the Experimental and Control Classes (Pre and Post-Test).

Figure 3 tells some examples of the students' drawing results at the mental model level 2, 3, 4, and 5. The level 2 drawing test results show that the students only drew a sphere and an image resembling inappropriate bacteriophage. The level 3 drawing test results indicate that the students only described the bacteriophage virus by giving the incomplete description of parts of the structure of a virus and misconceptions were still there. The level 4 drawing test results show that the students drew two structures of the naked virus and enveloped virus equipped with more complete descriptions of the image, but the description of the enveloped virus was less precise. The level 5 drawing test results indicate that the future Biology teachers drew the complete structure of the virus, there was a naked virus and a membrane virus. At the pre-test, the prospective teacher students both in the control and the experimental class drew bacteriophage structure of a virus only. This was due to their learning experiences in studying the virus during high school, in which only discussing bacteriophages. High school textbooks discuss the life cycle of bacteriophage as an example of a naked virus. Some high school textbooks also tell about the enveloped virus and describe the life cycle of the HIV virus.

The prospective Biology teachers seemed to have no difficulty in drawing the virus. This was because they are used to draw biological objects in the previous course (in semester 5) before joining the Microbiology course. Drawing is a common learning activity that is always be done by students in science/biology lesson since primary high school. Drawing mostly used to record observation data such as organism's cells, tissues, organs, and organism/ microorganism specimens. Images can represent a model expressed by a person about a particular phenomenon existing in the public domain, including the ability to write the virus structure and shows the level of a person's mental model (Leutner et al. 2009; Zhang, 2008; Yayla & Eyceyurt, 2011). These results are different from the results of research on Biology teacher candidates in Turkey. Most of the prospective teachers have difficulties in describing animal and plant cells (Celiker, 2015). Nevertheless, the research result of Ormanci & Ören (2011) that 80% of the pre-service science and technology teachers stated that they would like to employ the drawing method during their in-service career.

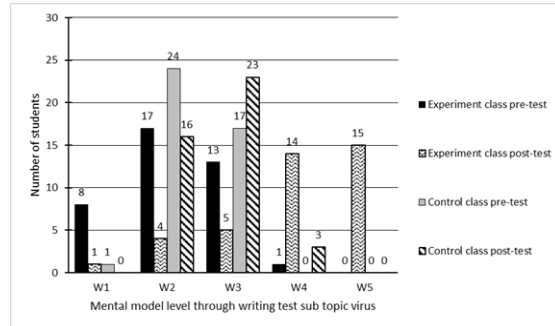


Figure 2. The Mental Model Levels of Prospective Biology Teachers on Structure of a Virus through Writing Tests in the Experimental and Control Classes (Pre and Post-Test).

Examples of prospective Biology teachers' mental models on structure of a virus through writing tests can be seen in Table 4. The level 5 of writing can be achieved by the students if they are able to write the virus structure. Students should explain the structure of naked and enveloped virus, including the core material presented in the virus. In the pre-test, many students explained bacteriophage only. After the new treatment was given, there was a change in the students' mental model about the structure of the virus, including naked and enveloped virus. This indicates that the application of mental model on microbiological learning provided meaningful learning. The students obtained new information and synergized the old knowledge relevant to the new information in constructing a new mental model. Jia (2010) stated in forming a correct model, the students should be given opportunities to test the model.

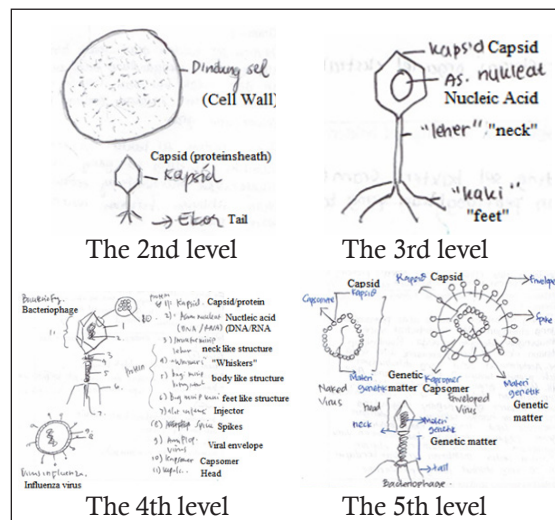


Figure 3. The Examples of Drawing Test Results on Structure of a Virus at Level 2, 3, 4, and 5.

The identification of prospective Biology teachers' mental models through drawing-writing test can provide information about ideas of the students. The results of the pre-test through drawing-writing served the initial information on how deep the students the knowledge. In Biology, drawing skill is not a something new that the students must have. However, combining the writing and writing skill to explain an idea is rarely found. Integrating the drawing-

writing instruments to see the students' mental models for generating ideas is in line with Oren & Ormanci's (2014) and Nugraha (2018). Stains & Sevian (2014) also employed the drawing-writing instrument to find out the mental model of diffusion concept. Images with explanations will dig the students' deeper ideas about a concept. Interpretation of images and interviews also provides effective results in biology course (Dikmenli, 2010).

Table 5. The Examples of Prospective Biology Teachers' Mental Models on Virus Structure through Writing Test.

Mental Model Levels	Writing
W2	Viruses contains only genetic material without cells. The virus penetrates with its tail fibers.
W3	Viruses have a capsid acting as a protective nucleic acid composed of proteins. The nucleic acid in the virus can be either RNA or DNA. Having a neck-like structure serves as a conduit for the discharge of nucleic acids and a leg-like structure serves as a place of attachment to the host.
W4	Viruses consist of 2 main parts; capsid and nucleic acid (RNA or DNA). Capsid consists of structural proteins (capsomers). Some viruses have envelopes. Bacteriophages have neck-like and leg-like structures.
W5	Viruses are composed of genetic material (RNA / DNA) and proteins. Capsid is a sheath of protein that protects the viral genetic material. The capsid is composed of capsomers. There are 2 types of viruses; naked virus and enveloped virus. Bacteriophages have head -like structures containing genetic material.

Based on the above explanation, we know how important the integration between drawing skill as visual ability and writing skill as verbal ability is. Then how both verbal and visual information are integrated? Mayer (2009 in Quilin & Thomas, 2015) proposed his cognitive theory of multimedia learning stating that a student create his/her mental model in working memory by performing three cognitive tasks which are as follows: 1) selecting verbal and visual information from the material presented (sensory processing) and from prior knowledge (long-term memory); 2) organizing verbal and visual information; and 3) integrating those elements into the mental model. The importance of the drawing-writing test is reinforced by the opinion of Kurt et al. (2013) who explained that this test is very effective in generating natural and quality data about students' opinions, understanding, and posture about certain concepts.

CONCLUSION

The results show that the students in the experimental class had better improvements on their mental model level through drawing-writing test after joining the Microbiology course-based mental model on virus structure concept, compared to the students in the control group. The highest mental model level of the experimental class after the treatment was D5 / W5. There was a level 1 of writing and a level 4 of drawing (D4/W1) found in the experimental class. No one of the students in the control class reached D5 / W5 level. The results of this study indicated that the drawing-writing tests were effective to see changes in the prospective Biology teachers' prior mental model toward the target mental model. The drawing-writing skills on the structure of viruses are the expressions of the prospective Biology teachers' mental models of the concepts.

ACKNOWLEDGEMENTS

This article is part of the researchers' writings on the Research Doctoral Dissertation report for the fiscal year of 2017. Therefore, the researchers would like to thank the Directorate of Research and Community Service, the General Directorate of Research and Development, the Ministry of Research, Technology and Higher Education of the Republic of Indonesia which has funded this research. In addition, our special thank goes to Prof. Sri Redjeki, M.Pd., for her precious suggestions in this research.

REFERENCES

- Albaiti, Liliyasi, Sumarna, O. (2016). The Study of Mental Model on N-Hexane-Methanol Binary System (The Validation of Physical Chemistry Practicum Procedure). *Jurnal Pendidikan IPA Indonesia*, 5(1), 6-13.
- Buckley, B.C. & Boulter, C.J. (2000). Investigating the Role of Representations and Expressed Model in Building Mental Models. Dalam Gilbert, J.K. & Boulter C.J. (editor). *Developing models in science education* (pp. 119-135). Dordrecht Kluwer Academic Publishers.
- Byrne, J. (2011). Models of Micro-Organisms: Children's knowledge and understanding of micro-organisms from 7 to 14 years old. *International Journal of Science Education*, 33(14), 1927-1961.
- Celiker H.D. (2015). Prospective Science Teachers' Levels of Understanding and Explanation of Animal and Plant Cells: Draw-Write. *Journal of Baltic Science Education*, 14(4), 501-512.
- Coll, R. K. (2009). Do Gifted Students View and Use Mental Models Differently from Others? *Educacion Química*, 1(1), 18-31.
- Dikmenli, M. (2010). Misconceptions of Cell Division Held by Student Teachers in Biology: a Drawing Analysis. *Scientific Research and Essays*, 5(2), 235-247.
- Duit, R., Widodo, A., & Wodzinski, C.T. (2007). Conceptual Change Ideas: Teachers' Views and Their Instructional Practice. Vosniadou, S., Baltas, A., & Vamvakoussi, X. (Eds). *Reframing the Conceptual Change Approach in Learning and Instruction*. Netherland: Elsevier.
- Hamdiyati, Y., Sudargo, F., Redjeki, S., and Fitriani, A. (2017). Biology Students' Initial Mental Model about Microorganism, *Journal of Physics: Conf. Series* (812), IOP Publishing.
- Hamdiyati, Y., Sudargo, F., Redjeki, S., & Fitriani, A. 2018. Using Concept Maps to Describe Undergraduate Students' Mental Model in Microbiology Course. *Journal of Physics: Conf. Series* 1013 (2018) 012014. IOP Publishing.
- Hamid, R. (2016). Model Mental Siswa Sekolah Dasar tentang Listrik Statis. *Jurnal Pengajaran MIPA*, 21(1), 24-29.
- Jee, B. D., Uttal, D. H., Spiegel, A., & Diamond, J. (2015). Expert–Novice Differences in Mental Models of Viruses, Vaccines, and the Causes of Infectious Disease. *Public understanding of science*, 24(2), 241-256.
- Jia, Q. (2010). A Brief Study on the Implementation of Constructivism Teaching Theory on Classroom Teaching Reform in Basic Education. *International Education Studies*, 3(2), 197-199.
- Jones, G., Gardner, G.E., Lee, T., Poland, K., & Robert, S. (2013). The Impact of Microbiology Instruction on Students' Perceptions of Risks Related to Microbial Illness. *International Journal of Science Education*, 3(3), 199–213.
- Kelwick, R., Bowater, L., Yeoman, K. H., & Bowater, R. P. (2015). Promoting microbiology education through the iGEM synthetic biology competition. *FEMS microbiology letters*, 362(16), 1-8.
- Khasanah, N., Wartono, & Yuliati, L. (2016). Analysis of Mental Model of Students Using Isomorphic Problems in Dynamics of Rotational Motion Topic. *Jurnal Pendidikan IPA Indonesia*, 5(2), 186-191.
- Kurnaz, M.A. and Emen, A. Y. (2013). Mental Models of the High School Students Related to the Contraction of Matter. *International Journal of Educational Research and Technology*, 4(1), 1-5.
- Kurt, H. (2013a). Turkish Student Biology Teachers' Conceptual Structure and Semantic Attitudes towards Microbes. *Journal of Baltic Science Education*, 1(5), 085-093.
- Kurt, H. & Ekici, G. (2013b). What is a Virus? Prospective Biology Teacher' Cognitive Structure on the Concept of Virus. *Internasional Online Journal of Educational Sciences*, 5(3), 736-756.
- Kurt, H., Ekici G., Aksu Ö, and Aktas M. (2013c). Determining Cognitive Structures and Alternative Conceptions on the Concept of Reproduction (The Case of Pre-Service Biology Teachers). *Creative Education*, 4(9), 572-587.
- Leutner, D., Leopold, C., & Sumfleth, E. (2009). Cognitive load and science text comprehension: Effects of drawing and mentally imagining text content. *Computers in Human Behavior*, 25(2), 284-289.
- Norman, D. A. (2014). Some observations on mental models. In *Mental models* (pp. 15-22). Psychology Press.
- Nugraha, I. (2018). The Use of Drawing as an Alternative Assessment Tool in Biology Teaching. *J. Phys.: Conf. Ser.* 1013 (2018) 012016. IOP Publishing.
- Núñez-Oveido, M. C., Clement, J., & Rea-Ramirez, M. A. (2008). Developing complex mental models in biology through model evolution. In *Model based learning and instruction in science* (pp. 173-193). Springer, Dordrecht.
- Oren, F.S. & Ormanci, U. (2014). Exploring Pre-Service Teachers' Ideas about the Digestive System by Using the Drawing Method. *Journal of Baltic Science Education*, 13(3), 316-326.

- Ormanci, U. & Ören F S. (2011). An analysis of pre-service teachers' drawings about the digestive system in terms of their gender, grade levels, and opinions about the method and subject. *International Journal of Biology Education*, 1(1), 1-22.
- Quilin, K. & Thomas, S. (2015). Drawing-to-Learn: A Framework for Using Drawings to Promote Model-Based Reasoning in Biology. *CBE-Life Science Education*, 14(1), 1-16.
- Rea-Ramirez, M.A., Clement, J., & Nunez-Oveido, M.C. (2008). An Instructional Model Derived from Model Construction and Criticism Theory. J.J. Clement and M.A. Rea-Ramirez (Eds). *Model Based Learning and Instruction in Science*. London: Springer. P. 23-43.
- Saptono, S., Isnaeni W., Sukaesih, S. (2017). Undergraduate Students' Mental Model of Cell Biology. *Jurnal Pendidikan IPA Indonesia*, 6(1), 145-152.
- Schaechter, M., Kolter, R., & Buckley, M. (2004). *Microbiology in the 21st Century: Where Are We and Where Are We Going?* American Academy of Microbiology Charleston, South Carolina.
- Smith, M. K., Wood, W. B., & Knight, J. K. (2008). The genetics concept assessment: a new concept inventory for gauging student understanding of genetics. *CBE—Life Sciences Education*, 7(4), 422-430.
- Stains, M. & Sevian, H. (2014). Uncovering Implicit Assumptions: A Large-Scale Study on Students' Model Mentals of Diffusion. *Research Science Education*, 10(45), P. 807-840.
- Tortora, G. J., Funke, B. R., Case, C. L., & Johnson, T. R. (2004). *Microbiology: an introduction* (Vol. 9). San Francisco, CA: Benjamin Cummings.
- Wiji, Liliyasi, Wahyu Sopandi, & Muhammad A. K. Martoprawiro. (2014). Profil Motivasi Belajar Mahasiswa Calon Guru Kimia dan Korelasinya terhadap Model Mental. *Jurnal Pengajaran MIPA*, Volume 19, Nomor 2, Oktober 2014, P. 233-240
- Yayla, R. G. & Eyceyurt, G. (2011). Mental Models of Pre-service Science Teachers about Basic Concepts in Chemistry. *Western Anatolia Journal of Educational Science (WAJES)*. Selected Papers Presented at WCNTSE. Dokuz Eylul University Institute, Izmir, Turkey ISSN 1308-8971.
- Zhang, Y. (2008). The Influence of Mental Models on Undergraduate Students' Searching Behavior on the Web. *Information Processing and Management*, 44, 1330-1345.



TWO PROBLEM SOLVING CYCLES TO ACHIEVE LEARNING OUTCOMES OF THINKING SKILLS AND PLANT ANATOMY CONCEPT MASTERY

R. P. Puspitawati*¹, L. Yuanita², Y. S. Rahayu³, S. Indana⁴, E. Susiyawati⁵

^{1,2,3,4}Universitas Negeri Surabaya, Surabaya, Indonesia

⁵School of Education, Curtin University, Western Australia

DOI: 10.15294/jpii.v7i3.14295

Accepted: May 31st, 2018. Approved: August 31st, 2018. Published: September 20th, 2018

ABSTRACT

The purpose of this study was to measure the effectiveness of two problem-solving cycles. The effectiveness of thinking skills was measured through the achievement of learning outcomes of problem solving skills and mastery of the concept of Plant Anatomy. The study was conducted on 96 students at Plant Anatomy course. The research type was quantitative research with a quasi-experiment method. The research design used one group pretest-posttest design. The collected data were analysed descriptively based on the percentage of learning mastery and the average of N-gain. The data indicated a significant difference in the students' problem-solving skills between the pre-test and post-test with the N-gain value was categorized as a medium level. Moreover, 75% of learning indicators have been completed by the students. In relation to the conceptual understanding, the results showed that the percentages of students who could complete the topics of a stem, a root, and a leaf were 80,21%, 71,88%, and 84,98%, respectively. Therefore, it suggested that the two cycles of problem-solving cycles implemented in this study were effective.

© 2018 Science Education Study Program FMIPA UNNES Semarang

Keywords: problem solving, thinking skills, plant anatomy

INTRODUCTION

Regular cognitive skills show a significant decline in the 21st Century, while demands on high-level thinking skills and complex communications propose significant year-to-year increases. Thinking skills are the main competency to solve problems, especially high-level thinking skills. The high-level thinking, including problem-solving skills, is very important for students to have in order to deal with the competitive job world (Mavinkurve & Patil, 2016; Isaria et al., 2016; Rotherham, 2010).

Problem-solving is a process to achieve goals in complex problems (Wang & Chiew, 2010;

Fischer et al., 2015; Effendi, 2016). In addition, good problem-solving skills can help students transfer their knowledge and understand the physical situation. Problem-solving skills should be trained at all levels of education to address the 21st-century challenges (Kirmizi, 2015; OECD, 2013). Problem-solving skills are individual competence to find solutions in various problems through logical means (OECD, 2014; Dostal, 2015; Demirel, 2015). These skills are the basis for constructing knowledge and increasing effective independent learning (Finch, 1999; Lesh & Zawojewski, 2007; Chou & Chen, 2009.).

Mostly, the results of the continuous research by PISSA show that the problem-solving skills in Higher Order Thinking Skills of Indonesian students were deficient (OECD, 2013;

*Correspondence Address

E-mail: riniepratiwi@unnesa.ac.id

OECD, 2016). Research on problem-solving skills for students who took morphology and anatomy courses also show dissatisfying results (Puspitawati, 2017). The context of learning experienced by students becomes one of the factors causing low critical thinking and problem-solving skills. Problem-solving skills are trained and obtained in the context of specific materials through specific strategies (Hoskinson, et al., 2013).

Efforts to train problem-solving skills through a problem-solving strategy related to Plant Anatomy material contexts indicated high results for problem-solving skill mastery but low for Plant Anatomy concept mastery (Prastiwi & Indah, 2012). It is possible that students tend to memorize only the same problems they had previously encountered to be repeated and applied on another problem resolution. This is because most students do not solve the problem by analyzing the situation and applying the concept to get the answer. Few students can apply a scientific approach to solve problems since they lack concepts (Riantoni et al., 2017).

Students' achievements during the implementation of problem-based learning tend to the repetition of existing theories instead of the discovery of a new concept. The success of students' learning is indicated by the number of concepts that they have learned without giving an emphasis how the concepts are related each other (Yew et al., 2011). Students' learning

achievement is an accumulative process which involves collaborative learning. Another scholar recommended the need of different studies in organizing knowledge that may affect the use of knowledge in new contexts (Schmidt et al., 2011). The implementation of problem-based learning can be categorized into three types: (1) information is processed using the principles of mental model construction; (2) learning process is oriented to problem-solving and reasoning skills; and (3) learning strategy supports students to learn learning skills (Schmidt et al., 2011).

The research results have provided an opportunity to manage learning that can help students use problem-solving skills based on their concept mastery. Students who can solve problems characterize that they know the concept and have good problem-solving skills.

In this study, the learning management consisted of two problem-solving cycles to achieve the learning outcomes of Plant Anatomy concepts and problem-solving skills. The problem solving itself generally consists of several stages like orientation to the problem, defining and formulating problems, formulating or finding alternatives, making decisions and verification (Phungsuk et al., 2017; Jayaram et al., 2010; Cooperrider & Whitney, 2010).

The learning management steps with two problem-solving cycles are illustrated as in (Figure 1)

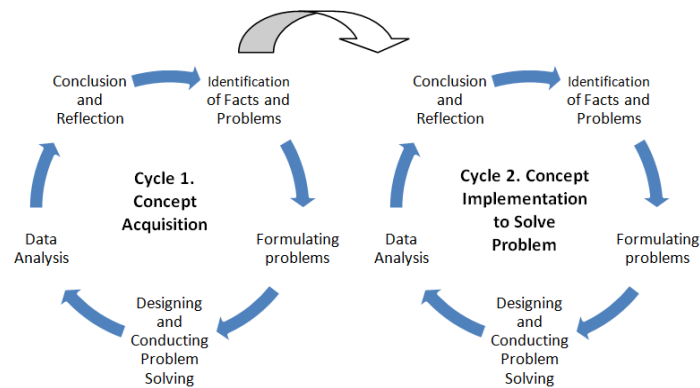


Figure 1. Two Problem Solving Cycles for Acquiring Concepts and Problem Solving Skills

The stages of problem-solving learning in each cycle consisted of (1) identifying the problems; (2) formulating the problems; (3) designing & implementing problem-solving steps; (4) analyzing results; and (5) concluding and reflecting. The first cycle focused on acquiring the concept of plant anatomy, followed by the second cycle to implement the concept of the complex problem conditions associated with plant anatomical

phenomena. These two cycles allowed the students to apply their concepts through a scientific approach to solve problems (Riantoni et al., 2017). The two cycles were activity-based, so, it was an entity that could eliminate the tendency of the students to memorize similar problem-solving steps to be repeated and applied to another problem.

Activities in the two cycles were exploring facts and concepts to tackle the skills of analyzing, and solving problems, while also facilitating the students to the concept mastery. Exploration activities of facts and concepts were highly relevant to the content characteristics of plant anatomy materials. Plant anatomy materials present both factual and conceptual knowledge when it comes to studying the structure and function of plants. Procedural knowledge will be conveyed through the material content of the development of the anatomical structures. A factual, conceptual, and procedural review can be applied to describe phenomena, comparing two variables by examining differences and equations, as well as assessing causal correlations among variables associated with plant anatomical structures. The knowledge implemented for that is metacognitive knowledge.

The material characteristics described above are strong reasons to train problem-solving skills through plant anatomy materials. The problem-solving skills trained in each topic on plant anatomy materials will enrich the students' experience, as they relate the content to the concept application in the problem-solving process. The learning management is relevant to the cognitive-social theory which emphasizes that learning is the process of interaction and observing the environment through direct involvement (Moreno, 2010).

The purpose of this study is to determine the effectiveness of two problem-solving cycles seen from the learning outcomes of problem-solving skills and plant anatomy concept mastery. The problem proposed through this research was whether the two problem-solving cycles were effective to achieve the plant anatomy concepts mastery as well as problem-solving skills.

The effectiveness of the two cycles was based on (1) achievement of problem-solving skill indicators, (2) achievement of plant anatomy concept mastery indicators.

METHODS

This study followed the Pre-Experimental Designs of 'one-shot case study' (Fraenkel, Wallen, & Hyun, 2012; Creswell, 2014; Tuckman & Harper, 2012). This study was conducted on 96 students of Unesa Biology Education program, class of 2013/2014. The students were divided into three groups (A, B, and U) having respectively 36, 43 and 17 students each. This study was conducted at the even semester of 2016/2017 for 9 weeks. The lectures were held from February - June 2017 in Biology Department of FMIPA UNESA. The implementation of two cycles in these lectures was supported by the teaching materials, student activity guides, lecture courses, and valid assessment sheets.

The independent variable in this research was two problem-solving cycles. While the responded variable in this research was: (1) achievement of problem-solving skill indicators; and (2) achievement of plant anatomy concept mastery indicators. The indicators of problem-solving skills trained included eight skills, namely (1) identifying facts; (2) formulating questions; (3) formulating temporary answers; (4) identifying relevant factors; (5) determining alternative problem solving; (6) analyzing the results; (7) concluding; and (8) arranging the work plan (Airey & Linder 2009, Gormally et al., 2009; Henderson, et al. 2011). The indicators of mastery of anatomical concepts include mastery of concepts on the topics of stems, roots, and leaves (Table 1).

Table 1. The Plant Anatomy Concept Indicators

No	Indicators on Sub Topics		
	Stem	Root	Leaf
1.	Describing the stem epidermal structure	Describing the root epidermal structure	Describing the systolic structure
2.	Describing the structure and tissue of the stem cortex constituents	Describing the structure and tissue of the root cortex constituents	Describing the lithocyte structure
3.	Describing the stem endodermic structure.	Describing the root endodermic structure.	Describing the palisade structure
4.	Describing the structure of the stem vessel constituents.	Describing the structure of the root vessel constituents.	Describing the structure of sponsa
5.	Describing the structure of the xylem tissue.	Describing the structure of the xylem tissue.	Describing the stoma structure based on its type

6.	Describing the structure of the phloem tissue.	Describing the structure of the phloem tissue.	Mentioning the special features of gymnosperm leaves
7.	Describing the structure of the stem pith parenchyma.	Describing the structure of the root pith parenchyma.	Describing the leaf epidermal abaxial structure
8.	Summing up the stem anomaly structure.	Summing up the root anomaly structure.	Describing the crystal structure on the leaf base tissue
9.	Describing arguments on the stem anomaly structure	Describing arguments on the root anomaly structure	Describing the trichome structure based on its type
10.	Concluding the occurrence of secondary growth based on changes in the stem structure.	Concluding the occurrence of secondary growth based on changes in the root structure	Distinguishing the structure of trichome and papilla
11.	Explaining the arguments on stem secondary growth.	Explaining the arguments on stem secondary growth.	Describing the abaxial leaf epidermal structure
12.			Describing the structure of the leaf vessels
13.			Concluding the leaf symmetry based on the basic network structure that compiling it

The data analysis was done both descriptively and quantitatively by calculating the proportion of learning indicator achievement. The mastery learning was the achievement of the minimal proportion of indicators at the minimum of 0.7. Classical mastery was based on the percentage of learning achievement ≥ 70 which was set at the 70% minimum for the students. The data analysis began with the differential test of ANOVA or Kruskal-Wallis (Trihendradi, 2012). The test was to see if there were significant differences in the outcomes among the three groups.

RESULTS AND DISCUSSION

Implementation of two problem-solving cycles was carried out for stem, root and leaf topic. The response variable was the achievement of problem-solving skill indicators and Plant Anatomy concept. The following will present the results for each of these variables.

Problem-solving skills

The learning outcomes of the problem-solving skills were measured through pre-test and post-test. The summaries of pre-test and post-test results obtained are presented in Table 2.

Table 2. The Summary of the Problem-Solving Skill Learning Outcomes

Class	Topic	Number of Students	(Mean)	Std. Deviation	N-gain mean
Biology Education A	Pre-test	36	49.08	11.78	0,303
	Post-test	36	65.61	08.09	
Biology Education B	Pre-test	41	43.58	10.59	0,364
	Post-test	41	64.41	10.71	
Biology Education U	Pre-test	17	48.23	09.76	0,335
	Post-test	17	66,34	10.80	

Statistical analysis was performed on SPSS 16.0. The normality and homogeneity test results in derived from three class groups (A, B, and U) showing normal and homogeneous data distribution. Different ANOVA test results on the N-gain pre-test and post-test of three classes showed

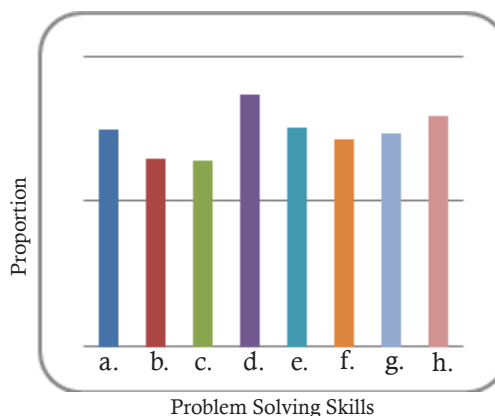
that the three classes were not significantly different (significance value $0.32 > 0.05$, H_0 accepted). Anova's different test results show that the three groups of classes were not significantly different. Therefore, it can be inferred that the learning management process conducted on the three groups

were the same. The results of paired t-test between pre-test and post-test show that there were significant differences (the significance value of $0.000 < 0.05$, H_0 rejected). The results of paired t-test show that the learning management of the two problem-solving cycles gave an effect because the pre-test and post-test results were significantly different. The pre-test and post-test results were also analyzed to see the achieved mastery learning and the N-gain obtained by each student categorized into low, medium and high. The data obtained are presented in Table 3.

Table 3. The Students Percentage of the N-Gain Predicate and Achieved Mastery Learning

Class	The Students Percentage of the N-Gain Predicate		Percentage of the Students' Completion	
	Low	Medium	Pre-test	Post-test
Biology Education A	50,00	50,00	22,22	80,60
Biology Education B	31,70	68,29	7,75	65,90
Biology Education U	41,10	58,80	17,64	82,35
Mean	40,93	59,03	15,87	76,28

Table 3 tells the mean achievement of N-gain was in the medium category, and the number of students who reach the average mastery learning was above the minimum 76.28%. The accomplishment for each problem-solving skill indicator is presented in Figure 1.



- Information
- a. Identifying facts;
 - b. Formulating questions;
 - c. Formulating temporary answers;
 - d. Identifying related factors;
 - e. Determining alternative problem solving;
 - f. Analysis of results;
 - g. Arranging work plan;
 - h. Arranging conclusions;

Figure 1. Learning Outcomes of Problem Solving Skills

Figure 1 describes the two unachieved indicators which were formulating questions and formulating a temporary answer. The indicators were achieved with the highest proportion on the identifying the related factors followed by the drawing a conclusion. Among the eight indicators, there were achieved six indicators, which means that the total number of the achieved indicators was 75%.

Plant Anatomy Concepts

The learning results of plant anatomy concepts were obtained through the tests at the end of each course topic. The assessment instrument used has been validated by the experts. The statistical analysis results of the learning result score are presented in Table 4.

Table 4. The Learning Results of Plant Anatomy Concepts

Class	Topic	Number of Students	(Mean)	Std Deviation
Biology Education A	Stem	36	70.19	10.482
	Root	36	69.64	11.028
	Leaf	36	71.97	8.687
Biology Education B	Stem	41	71.56	11.726
	Root	41	68.44	10.252
	Leaf	41	71.12	7.349
Biology Education U	Stem	17	71.24	11.508
	Root	17	68.12	11.302
	Leaf	17	69.76	7.612

The statistical analysis was performed on SPSS 16.0. Normality and homogeneity test results in data derived from the three class groups (A, B, and U) show the normal and homogeneous distribution of the data. The results of Anova's difference test on the score of plant anatomy concept of the three classes showed that all classes were not significantly different (significance value $0.858 > 0.05$, H_0 accepted). Anova's difference

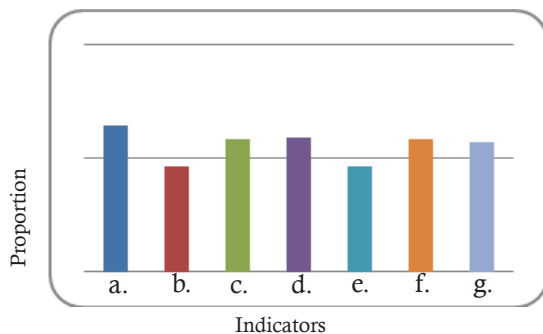
test results indicate that between the three groups of classes were not significantly different. Therefore, it can be interpreted that the learning management process conducted on the three groups were the same.

The learning results of plant anatomy concepts were also analyzed to see the achievement of mastery learning obtained by each student. The data were presented in Table 5.

Table 5. The Percentage of the Students Achieving the Minimum Threshold of Mastery Learning on Plant Anatomy Concepts

Topic	Percentage of achieved students			
	P.Biology A	P. Biology B	P. Biologi U	Mean
Stem	77,78	80,49	82,35	80,21
Root	77,78	73,17	64,71	71,88
Leaf	86,11	90,24	78,60	84,98

Table 5 elucidates that the percentages of students who achieved the minimum threshold of mastery were 80.21% for stem topic, 71.88% for root topic and 84.98% for leaf topic. The indicator achievement was analyzed referring to the Plant Anatomy concepts for each topic, which can be seen in Table 5. The results of the indicator achievement analysis indicate that 80% of the indicators were accomplished, and the proportion of achievement was above 0.7. In addition, 20% of the unaccomplished indicator can be seen in Figure 2.



Information

- Describing the stem endodermic structure;
- Explaining the stem anomaly structure argument;
- Describing the network structure of the root vessels composition;
- Summing up the root anomaly structure;
- Summing up the occurrence of secondary growth based on changes in root structure;
- Describing systolic structure;
- Describing the trichom structure based on its type.

Figure 2. Mastery Learning Accomplishment on the Unachieved Indicators

The implementation of two problem-solving cycles in the three class groups gave the same results in terms of Anova analysis, showing no other factors affecting the results obtained.

Problem-solving Skills

Previous research shows that problem solving skills can be mastered if presented in relation to material content (Racine, et al., 2011; Green, & Ruggiero, 2017;). Problem solving learning is proven to help students develop the ability to discuss, ask, and think critically (Schmidt et al., 2011). Long research has shown that problem solving skills can be mastered by students through the management of learner-centered learning that is linked to daily life (Chang, et al., 2017). Other research shows that the results obtained are more likely to repeat concepts than the emergence of new concepts, and the imbalance between acquisition of concepts and problem solving skills (Yew, Chng, Schmidt, 2011; Prastiwi & Indah, 2012).

Two effective problem-solving cycles have proven effective in achieving the learning outcomes of problem-solving skills. The implementation of two problem-solving cycles allowed repetition to practice problem-solving skills and examine concepts. It could increase memory through the activity of assessing knowledge to gain knowledge retention (Destalia, et al., 2014).

The problem-solving skill results between pre-test and post-test were significantly different, the completed indicator percentage was 75%, having the mean of N-gain in the medium category. The same N-gain category was also found in Wahyuni et al., (2017). Other research studies have

shown that problem-solving learnings have successfully fostered students' problem-solving and thinking skills in various academic fields (Eyler, 2009; Li et al., 2011, Hambach et al., 2016, Magdalena et al., 2014).

The overall results show that the two problem-solving cycles effectively achieved the goal of concept mastery and problem-solving skills (Les-tari, 2016). Tackling the problem-solving skills is closely related to the material content. Instead, the material content will be mastered properly if the acquisition is through scientific ways of thinking in solving the problem. The learning process occurred in each problem-solving cycle always begin with presenting the problem of plant anatomy in the context of students (Riadi et al. 2017). Problems will enable preliminary knowledge that allows students to connect new information with the existing one (Sitti et al., 2013; Ristiasari et al., 2012).

The activity of formulating problems and planning the problem-solving steps allowed students to gain inquiry experience on complex tasks related to plant anatomical phenomena (Chang et al., 2017). The research results show the skills of formulating questions and answers were not achieved. In fact, these skills are highly dependent on critical thinking skills and breadth of material content. The skill of formulating tentative answers is something that requires a lot of skills prerequisites, such as Wahyuni's et al. (2017) research results, which also show the lowest score on it.

The skills of identifying related factors, determining alternative problem solving, formulating the work plan, analyzing the results, and drawing conclusions were achieved. This was closely related to the presentation of problems in the context of the students, and the first cycle learning process was also relevant to the concept of proximal development zone (Moreno, 2010). The process of exploring problem-solving was also relevant to the constructivist principle according to the BSCS, beginning with the Engaging phase (Invitation) (Carriger, 2015). In the problem-solving process, teachers do not provide knowledge, but students must seek and find it through the series of activities in which they act as a problem solver (Syofyan & Halim, 2016). The approach differs from the approach which oriented to clarification, explanation, demonstration, and evaluation.

The average N-gain on the problem-solving skills learning outcomes was in the medium category, showing an increase in the post-test compared to the pre-test. This increase was possible because there were repetitive learning processes, i.e.

two cycles for each topic of study. The learning experiences in the first cycle can be a scaffolding for the second cycle (Amri, 2013; Slavin, 2011; Nurmaliah et al., 2013).

Two problem-solving cycles for each topic had the opportunity to develop critical thinking and problem-solving skills. The first cycle provided the experience to solve complex problems in the second cycle. For example, in the first cycle of stem topic, the students developed problem-solving steps to answer the question "what is the stem structure equation in related plants?". In the second cycle, the students solved the problem in a more complex context that was "how to structure the same plant type stems in the different environment?". The learnings let the students think critically and solve problems, as they dealt with specific conditions in the material content. It broke down the students' direct access to all information over the internet that might cause negative effects since they simply adopted information without analyzing, interpreting and critically thinking (Purcell et al., 2012).

Plant Anatomy Concepts

The learning outcomes of plant anatomy concept significantly show the achieved students percentage of 80,21% for stem topic, 71,88% for root topic, and 84,98% for leaf topic, the mastery learning completeness of the indicators scored 80%.

Two concrete problem-solving cycles presented a number of plant anatomical phenomena as the learning materials. The students were trained to develop problems, gather information and design problem solving and provide explanations of the revealed phenomenon. This is in line with the opinion of Schmidt et al. (2011) and Destalia et al. (2014) who stated that problem-solving learning is characterized by presenting a carefully constructed set of problems and presenting it to groups of students.

The students were facilitated to discuss the problems and produce tentative explanations for the phenomena described in the problems. The set of problems presented could serve as modeling instruction, which had a positive impact on the research as what Sujarwanto et al. (2014) found in their research. The set of problems presented in this study were divided into two, namely the set of problems of cycle one and cycle two. The problems studied in the second cycle strongly supported the acquisition of metacognitive skills, as revealed by Herlanti et al., (2017) research that problem-solving strategies are the most effective strategies for increasing metacognitive knowled-

ge. Another phenomenon arose was the percentage of students who fully mastered the concept on the last topic (leaf) got the highest score. This might be due to the content materials on the leaf topic which repeated the main concepts that have been studied on the stem and root topic, e.g. the concept of xylem and phloem. Initial knowledge of the concepts studied on the leaf topics was sufficient, thus, the students could learn in their adequate zone of proximal development.

Other results indicate the unfinished Plant Anatomy concept indicators on stem and root topic related to the concept of secondary growth. The concepts were examined through the phenomena of stem and root anatomy. The acquisition of the basic concepts of the first cycle was not yet optimal, resulting in difficulties in dealing with other plant specimens from different classes in the second cycle. This reinforces the notion that learning to gain concepts must begin with the facts and definitions of concepts. Concept mastery passed through several levels, namely concrete level, identity, classification and formal (Ersoy, & Baer, 2014). The same things applied in the teaching of concepts whose stages begin with defining concept structures, defining concepts, constructing examples to ensure that examples possess multiple traits, and arranging and displaying sequences referring to the students' current knowledge (Promentilla et al., 2017). The learning processes about the development of secondary structures of stems and roots adopted the same steps. On the leaf topic, the low-achieved indicators were associated with identifying and describing the special epidermal derivatives found on the leaves. It is a relatively new concept on leaf topic.

The learning process built through two problem-solving cycles allowed the students to study anatomy through self-selected specimens. This led the intensity of the students to interact with a different anatomy fact proposed by other students. The intensity of interaction through the facts and concepts exploration of anatomy greatly affected the concept mastery as a result of learnings (Damopolii et al., 2015; Puspitawati, 2017). Facts and concepts exploration could be conducted because the presented examples of phenomena were related to plant anatomy, which triggered the students to think critically. It is relevant to the principle of the practical activity sheet development to support critical thinking on genetic topics (Susantini et al., 2012). The results indicate that the context of learning could be a factor

that contributes to the construction of problem-solving skills (Racine, et al., 2011; Green, & Ruggerio, 2017)

CONCLUSION

The two problem-solving cycles in Plant Anatomy course were effective in achieving learning objectives of problem-solving skills and plant anatomy concepts. The data indicate a significant difference in students' problem-solving skills between pre-test and post-test with the N-gain value is categorized as a medium level. Moreover, 75% of learning indicators have been completed by the students. Related to conceptual understanding, the results show that the percentages of students who could complete the topics of a stem, a root, and a leaf are 80,21%, 71,88%, and 84,98%, respectively. Therefore, it is suggested that the two cycles of problem-solving cycles which were implemented in the current study were effective.

REFERENCES

- Airey, J., & Linder, C. (2009). A Disciplinary Discourse Perspective on University Science Learning: Achieving Fluency In a Critical Constellation of Modes. *Journal of Research in Science Teaching*, 46(1), 27-49.
- Amisyah, S., & Nurmaliah, C. (2015). Upaya Peningkatan Hasil Belajar Kognitif Melalui Model Problem Based Learning. *BIOTIK: Jurnal Ilmiah Biologi Teknologi dan Kependidikan*, 1(2), 87-92.
- Amri, S. (2013). Pengembangan dan Model Pembelajaran dalam Kurikulum 2013. *Jakarta: Prestasi Pustaka*.
- Carriger, S. (2015). Problem-Based Learning and Management Development-Empirical and Theoretical Considerations. *The International Journal of Management Education*, 13(3), 249-259.
- Chang, C., Chang, Ming, Chiu, B., Liu, C., Chiang, S. Wen, C., Hwang, F., Wu, F., Chao, P., Lai, D., Wu, S., Chang, C., Chen, W. (2017). An Analysis of Student Collaborative Problem Solving Activities Mediated by Collaborative Simulations. *Computers & Education*, 114, 222-235.
- Chou, S.W., & Chen, P.Y. (2009). The Influence of Individual Differences on Continuance Intentions of Enterprise Resource Planning (ERP). *International Journal of Human-Computer Studies*, 67(6), 345-355.
- Cooperrider, D. L., & Whitney, D. (2001). A Positive Revolution in Change: Appreciative Inquiry. *Public administration and public policy*, 87, 611-630.

- Creswell, W. J. (2014). *Research Design: Qualitative, Quantitative, Mixed Method Approaches 4th Edition*. USA: SAGE Publication.
- Damopolii, I., Hasan, A., & Kandowangko, N. (2015). Pengaruh Strategi Pembelajaran Inkuiri Bebas Dimodifikasi dan Kemampuan Memecahkan Masalah terhadap Keterampilan Proses Sains Mahasiswa Pada Praktikum Fisiologi Tumbuhan. *Pancaran Pendidikan*, 4(3), 191-200.
- Demirel, M. (2015). A Study on the Relationship between Reflective Thinking Skills towards Problem Solving and Attitudes towards Mathematic. *Procedia-Social and Behavioral Sciences*, 197(2015), 2086-2096.
- Destalia, L., Suratno., Apriliya S. (2014). Peningkatan Keterampilan Pemecahan Masalah Dan Hasil Belajar Melalui Penerapan Pembelajaran Berbasis Masalah (PBM) Dengan Metode Eksperimen Pada Materi Pencemaran Lingkungan. *Jurnal Pancaran*, 3(4), 213-224.
- Dostal, J. (2015). Theory of Problem Solving. *Procedia-Social and Behavioral Sciences*, 174(1), 2798-2805.
- Effendi, D. (2016). Implementasi Model Creative Problem Solving untuk Meningkatkan Kemampuan Metakognitif Berdasarkan Kemampuan Awal Matematis. *JPPM*, 9(2), 164-176.
- Ersoy, E., & Baser, Nes'e. (2014). The Effects of Problem-Based Learning Method in Higher Education on Creative Thinking. *Procedia - Social and Behavioral Sciences*, 116(2014), 3494 – 3498.
- Eyler, J. (2009). The Power of Experiential Education. *Liberal Education*, 95 (4), 24-31.
- Finch, L., Crunkilton, A. (1999). *Curriculum Development in Vocational Technical Education*. Boston: Allyn and Bacon.
- Fischer, A., Greiff, S., Wüstenberg, S., Fleischer, J., Buchwald, F., & Funke, J. (2015). Assessing Analytic and Interactive Aspects of Problem Solving Competency. *Learning and Individual Differences*, 39, 172-179.
- Fraenkel, J. R., Wallen, N. E., & Hyun, H. H. (2012). *How to Design and Evaluate Research in Education* (8th ed.). New York: McGraw-Hill.
- Gilles, C. N. R., Kratochwill, T. R., Felt, J. N., Schienebeck, C. J., & Vaccarello, C. A. (2011). Problem Solving Consultation: Applications in Evidence-Based Prevention and Intervention. In *The Oxford Handbook of School Psychology*.
- Gormally, C., Brickman, P., Hallar, B., & Armstrong, N. (2009). Effects of Inquiry-Based Learning on Students' Science Literacy Skills and Confidence. *International journal for the scholarship of teaching and learning*, 3(2), 16-22.
- Green, L., & Ruggiero, D. (2017). Problem Solving through Digital Game Design: A Quantitative Content Analysis. *Computers in Human Behavior*, 73, 28-37.
- Hambach, J., Diezemann, C., Tisch, M. (2016). Assessment of Students' Learn Competencies with the Help of Behavior Video Analysis-Are Good Students Better Problem Solver?. *Procedia CIRP*, 55(2016), 230 – 235.
- Henderson, M., Lee, S., Whitaker, G., Altman, L. (2011). Positive Problem-Solving: How Appreciative Inquiry Works. *Strategies and Solutions for Local Government Managers*, 43(3), 247-258.
- Herlanti, Y., Mardiaty, Y., Wahyuningtyas, R., Mahardini, E., Iqbal, M., Sofyan, A. (2017). Discovering Learning Strategy to Increase Metacognitive Knowledge on Biologu Learning in Secondary School. *Jurnal Pendidikan IPA Indonesia*, 6(1), 179-186.
- Hoskinson, A.M., Caballero, M.D., Knight, J.K. (2013). How Can We Improve Problem Solving in Undergraduate Biology? Applying Lessons from 30 Years of Physics Education Research. *CBE—Life Sciences Education*, 12(2), 153-161.
- Isari, D., Pontiggia, A., & Virili, F. (2016). Working with Tweets vs. Working With Chats: An Experiment on Collaborative Problem Solving. *Computers in Human Behavior*, 58, 130-140.
- Jayaram, J., Das, A., & Nicolae, M. (2010). Looking beyond the Obvious: Unraveling the Toyota Production System. *International Journal of Production Economics*, 128(1), 280-291
- Kirmizi, O. (2015). The Interplay among Academic Self-Concept, Self-Efficacy, Self-Regulation and Academic Achievement of Higher Education L2 Learners. *Journal of Higher Education & Science/ Yuksekogretim ve Bilim Dergisi*, 5(1), 32-40.
- Lesh, R. & Zawojewski, J. S. (2007). *Problem Solving and Modeling*. In F. Lester (Ed.). *The Second Handbook of Research on Mathematics Teaching and Learning*. Charlotte, NC: Information Age Publishing.
- Lestari, S. (2016, January). Analisis Kemampuan Technological Pedagogical Content Knowledge (TPACK) pada Guru Biologi SMA dalam Materi Sistem Saraf. In *Prosiding Seminar Biologi* (Vol. 12, No. 1, pp. 557-564).
- Li, Yuzhu., Yang, M., Klein, G., & Chen, H. (2011). The Role of Team Problem Solving Competency in Information System Development Projects. *International Journal of Project Management*, 29(7), 911–922.
- Magdalena, O., Mulyani, S., Susanty, E. (2014). Pengaruh Pembelajaran Model Problem Based Learning Dan Inquiry Terhadap Prestasi Belajar Siswa Ditinjau Dari Kreativitas Verbal Pada Materi Hukum Dar Kimia Kelas X Sman 1 Boyolali Tahun Pelajaran 2013/2014. *Jurnal Pendidikan Kimia (JPK)*, 3(4), 162-169.
- Mavinkurve, M., & Patil, M. (2016). Impact of Simulator as a Technology Tool on Problem Solving Skills of Engineering Students-A Study Report. *Journal of Engineering Education Transformations*, 29(3), 124-131.
- Moreno, R. (2010). *Educational Psychology*. New York: John Wiley & Sons, Inc.
- OECD. (2013). *PISA Result (Volume V): Creative Problem Solving: Students' Skills in Tackling Real-Life Problems*. Paris : OECD Publishing.

- OECD. (2014). *PISA Results (Volume IV): What Students Know and Can Do – Student Performance in Mathematics, Reading and Science*. Paris : PISA OECD Publishing.
- OECD. (2016). *PISA Results (Volume I): Excellence and Equity in Education*, Paris : OECD Publishing. Retrieved From http://dx.doi.org/10.1787_
- Phungsuk, R., Viriyavejakul, C., & Ratanaolarn, T. (2017). Development of a Problem-Based Learning Model Via a Virtual Learning Environment. *Kasetsart Journal of Social Sciences*, 38(3), 297-306.
- Prastiwi, M. S., & Indah, N. K. (2012). Profil Peringkat Pembelajaran Taksonomi Tumbuhan Tinggi Berbasis Proyek Untuk Melatih Mahasiswa Berpikir Kreatif. In *Seminar Nasional VII Pendidikan Biologi* (Vol. 9, No. 1, pp. 241-249).
- Promentilla M.A.B., Lucas, R.I.G., Aviso, K.B., Tan, R.R. (2017). Problem-Based Learning of Process Systems Engineering and Process Integration Concepts with Metacognitive Strategies: The Case of PGraphs for Polygeneration Systems, *Applied Thermal Engineering*, 127, 1317-1325.
- Purcell, K., Rainie, L., Heaps, A., Buchanan, J., Friedrich, L., Jacklin, A., ... & Zickuhr, K. (2012). How Teens Do Research in the Digital World. *Pew Internet & American Life Project*.
- Puspitawati, R. P. (2017). Strategi Penyelesaian Masalah Pada Perkuliahan Anatomi Tumbuhan Untuk Menumbuhkan Keterampilan Berfikir Melalui Ide Inovatif. *Jurnal Pendidikan Biologi*, 6(2), 108-116.
- Riadi, M., Armi, A., & Surya, E. (2017). Keterampilan Proses Sains Berbasis Inquiry Pada Praktikum Botani Tumbuhan Rendah Pada Calon Guru Pendidikan Biologi FKIP Pendidikan Biologi Universitas Serambi Mekkah. *Jurnal Biology Education*, 6(2).
- Riantoni, C., Yuliati, L., Mufti, N., Nehru. (2017). Problem Solving Approach in Electrical Energy and Power on Students as Physics Teacher Candidates. *Jurnal Pendidikan IPA Indonesia*, 6(1), 55-62.
- Ristasari, T., Priyono, B., Sukaesih, S. (2012). Model Pembelajaran Problem Solving Dengan Mind Mapping Terhadap Kemampuan Berpikir Kritis Siswa. *Journal Biology Education*, 1(3), 34-41.
- Rotherham, A. J., & Willingham, D. T. (2010). "21st-Century" skills. *American Educator*, 17, 17-20.
- Schmidt, H.G., Rotgans, J.I & Elaine H.J., Yew, E.H. (2011). The Process of Problem-Based Learning: What Works And Why. *Medical Education*, 45(8), 792–806.
- Sitti, S., Sopearak, S., & Sompong, N. (2013). Development of Instructional Model Based on Connectivism Learning Theory to Enhance Problem-Solving Skill in ICT for Daily Life of Higher Education Students. *Procedia - Social and Behavioral Sciences*, 103, 315 – 322.
- Slavin, Robert. E. (2011). *Educational Psychologies, Theories and Practice*. Pearson Education, Inc. New York.
- Sujarwanto, E., Hidayat, A., & Wartono, W. (2014). Kemampuan Pemecahan Masalah Fisika Pada Modeling Instruction Pada Siswa SMA Kelas XI. *Jurnal Pendidikan IPA Indonesia*, 3(1), 65-78.
- Susantini, E., Thamrin, M., Isnawati, Lisdiana, L. (2012). Pengembangan Petunjuk Praktikum Genetika Untuk Melatih Keterampilan Berpikir Kritis. *Jurnal Pendidikan IPA Indonesia*, 1(2), 102-108.
- Syofyan, H., & Halim, A. (2016). Penerapan Metode Problem Solving Pada Pembelajaran IPA Untuk Peningkatan Kemampuan Berpikir Kritis Siswa. In *Prosiding Seminar Nasional Multi Disiplin Ilmu & Call For Papers UNISBANK (SENDI_U) KE-2 Tahun*.
- Trihendradi, C. (2012). SPSS 20 Analisis Data Statistik. *Yogyakarta: Andi*.
- Tuckman, W. B. & Harper, E. B. (2012). *Conducting Educational Research*. USA: Rowman & Littlefield Publishers.
- Wahyuni, S., Indrawati, Sudartin, Suana, W. (2017). Developing Science Process Skills and Problem-Solving Abilities Based on Outdoor Learning in Junior High School, *Jurnal Pendidikan IPA Indonesia*, 6(1), 165-169.
- Wang, Y., & Chiew, V. (2010). On the Cognitive Process of Human Problem Solving. *Cognitive Systems Research*, 11(1), 81–92.
- Yew, E.H.J., Chng, E., Schmidt, H.G., (2011). Is Learning in Problem-Based Learning Cumulative?. *Advances in Health Sciences Education*, 16(4), 449-464.



APPLYING COLLABORATIVE RANKING TASKS TO IMPROVE STUDENTS' CONCEPT MASTERY AND GENERIC SCIENCE SKILLS

N. M. Pujani^{*1}, K. Suma², W. Sadia³, A. F. C. Wijaya⁴

^{1,2,3}Department of Physics Education, Faculty of Mathematics and Natural Sciences, Universitas Pendidikan Ganesha, Indonesia.

⁴Department of Physics Education, Indonesia University of Education, Indonesia.

DOI: 10.15294/jpii.v7i3.14304

Accepted: May 23rd, 2018. Approved: August 31st, 2018. Published: September 20th, 2018

ABSTRACT

The lack of students concept mastery and generic science skills underlying this research. The purpose of this research was to improve the students' concept mastery and generic science skill by applying the collaborative ranking-task model in Earth and Space Science learning. This type of research was a classroom action research, conducted in two cycles. The data were collected by observation technique, test, and questionnaire. The study was conducted on physics students amounted to 25 people (10 male and 15 female). The success of the study was determined by the grade point average which should be at least 70. The obtained data were analyzed descriptively. The results showed that there was an increase in the students' concept mastery starting from cycle 1 to cycle 2 ($\bar{X}x1=50$, $s1=11.4$ in the 'deficient' category; and $\bar{X}x2=64$, $s2=8.3$ in the 'sufficient' category). The generic science skills were numerically increased from cycle 1 to cycle 2 ($\bar{X}x1=58.4$, $s1=13.3$; $\bar{X}x2=62.8$, $s2=10.2$; in the 'moderate' category). The developed indicators of generic science skills included indirect observation, logic inference, and concept building. The mean score of student response was $\bar{X}x=58.6$; $s=6.7$ which was in the positive category.

© 2018 Science Education Study Program FMIPA UNNES Semarang

Keywords: collaborative ranking tasks, concept mastery, generic science skills

INTRODUCTION

The Earth and Space Science is a subject taught from elementary school to college level. The Earth and Space Science (ESS) has become an interesting subject for many people having either science or non-science educational background (Duschl & Grandy (2013). In Physics Education Department of Universitas Pendidikan Ganesha, ESS is a compulsory subject for physics teacher prospective students. This course aims to provide students with an understanding of concepts of the earth and space science as well as to develop generic science skills. Furthermore,

the course is also intended to develop students' thinking skill. Lelliote & Rollnick (2008) obtained that most of the students perceived astronomy subject relatively more difficult than that of earth science. This result was also reflected by the students' learning outcome of astronomy subject was quite low (Hudgin et al., 2008). A preliminary observation showed that only 25% of the students mastered the concept of ESS course in the Physics Education Department of Universitas Pendidikan Ganesha (Pujani, 2013). In addition, the generic science skills students were also not developed optimally (Pujani, 2013).

One of the factors contributing to the low percentage of students was the learning strategy applied by the lecturer. The Earth and Space

*Correspondence Address

E-mail: made.pujani@undiksha.ac.id

Science's learning was dominated by lecturing methods which did not facilitate the students' participation to develop their thinking skills. The students were less involved in collaborative work, so, there was no sharing of knowledge and discussion. In addition to learning strategies, teaching materials were also seen as the cause of low student learning outcomes. Lecturers lacked teaching materials that encouraged the students to discuss, work collaboratively, and develop reasoning. The above findings indicated that the students' modest concept mastery of ESS was due to the lack of optimal lecturing process, and lack of proper classroom activities. Puspitasari & Permanasari (2012) found that 87.16% of lecturers constantly applied information discussion method and exercise questions in the chemistry courses, although the lab facilities were adequate. The lessons were dominated by lectures, assignments, demonstrations, while lecturers less facilitated the needs of students in class discussions. This is what-so-called the traditional learning (Fraknoi, 2011). Traditional learning focuses more on the transmission of knowledge (subject content) from teachers to students through a passive acceptance process. Students learn through memorization so that the concepts they receive are quickly forgotten. This shows that traditional learning is less effective in maintaining students' concept mastery. Some studies have shown that the traditional learning model is less effective in developing students' understanding than the constructivist learning (Freeman et al., 2014; Ogan-Bekiroglu et al., 2014). In addition, the traditional learning model emphasizes less on the developing of students' thinking skills, such as generic science skills.

Science learning is an active process where students are physically and mentally active in constructing knowledge. Science education research shows that students' understanding increases if learning strategies involving activities in the learning process are applied. Therefore, the students' active involvement in learning will lead to an increase in students' concept mastery and generic science skills. Some research done by Freeman et al. (2014); Saprudin et al. (2010); Wijaya & Ramalis (2012); Anwar (2014); and Harahan et al. (2017) showed that active learning is effective in developing the concept mastery and generic science skills.

The concept of mastery is the students' mastery level of the materials taught in a subject. There are three criteria of mastery, namely: the coherence of well-defined parts of concepts, the correspondence between a person's internal rep-

resentation and the conceptual material that can be understood, and the relationship between one's background knowledge with the studied matters (Matlin, 2003).

Generic Science Skills (GSS) are basic skills that future teachers need to have, applicable to a variety of fields, and independent knowledge of a particular domain but lead to cognitive strategies (Gibb, 2002). According to Brotosiswoyo (2000), there are 9 (nine) the GSS indicators; direct observation, indirect observation, scale awareness, symbolic language, principle-based theoretical framework, logical inference, causal law, mathematical modeling and concept building

To address the issues outlined above, there was a need for action interventions that lead to student-centered learning to increase activity and involvement in learning. Such learning should also be able to develop and improve the concept mastery and generic science skills. Learning should be aided by tasks that guide students to develop scientific thinking skills such as; formulating problems, collecting data and testing, testing through experiments, explanatory formulations, and application of concepts. One of the models suitable for the above concern is the collaborative ranking tasks.

The Collaborative Ranking Task (CRT) model is a learning model in the form of conceptual exercises combined with the collaborative activities of students in the classroom (Hudgins, 2008). The constructivism theory underlies this CRT model in which students build new knowledge by connecting the new one with their needs and capacities as well as integrating it to their own cognitive structure (Arend, 2007). There are 5 (five) stages in Collaborative Ranking Task learning; dealing with problems, data collection, experimental testing, explanatory formulation, and application of concepts.

In learning with the collaborative ranking task, teachers insert a task in the form of ranking task exercises to direct students' discussion activities during the lesson. This learning model has been developed by Wambu (2008) in physics lessons to improve students concept mastery. Henderson et al., (2012) developed a ranking task in physics learning combined with the "Physlet" simulation program. In astronomy, Hudgins (2008) developed a rank task combined with collaborative learning or collaborative ranking task to improve student astronomy. Wijaya (2009) uses the collaborative ranking task in e-learning assisted Earth and Space Science learning to develop students' concept mastery. Aktan & Dinçer (2014) uses ranking task questions

in assigning exams to prospective teachers for Kepler's law topics.

Referring to the findings of several studies on the CRT above, it turns out that the CRT model has been proven to offer significant results on the concept mastery, but no one has investigated the development of generic science skills in a CRT learning. Therefore, the researchers applied the CRT model in ESS learning, through classroom action research aimed at improving the students' concept mastery and generic science skills. The scope of the problem was limited to the implementation of collaborative-tasking exercises in ESS lectures for the Phase of the Moon and Kepler's Law. Through this intervention, it was expected that the students' concept mastery of ESS and the generic science skills increased significantly. In addition, it was also expected that this model could foster students to actively and crea-

tively involved, and at the same time make a fun learning. The researchers hoped that the results of these interventions became the foundation for educators to choose the Collaborative Ranking Task as an alternative learning on ESS subject.

METHODS

This research type was Classroom Action carried out to 25 students (10 males and 15 female) in the 6th-semester, Physics Education Department, Universitas Pendidikan Ganesha. The research object was the concept mastery, generic science skills, and students' responses to the model of the implemented learning. The research conducted in two cycles consisting of four stages each: planning, action, observation/evaluation, reflection. The research design adopted the Kemis& Taggart (1982) model as shown in Figure 1.

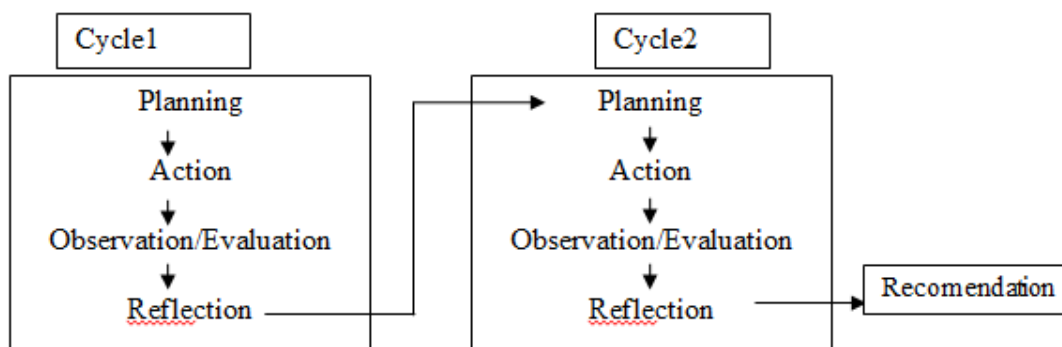


Figure 1. The Research Design

The cyclical determination was also based on the Earth and Space Science materials created in ranking task exercises (RTE) form. The materials in each cycle are shown in Table 1 below.

Table 1. The Earth and Space Science Materials

Cycle	Topic	Materials	Note
1.	Moon Phases	Moon revolution	1 meeting
		Eclipses	1 meeting
		Test of Cycle1	1 meeting
2.	Kepler's Laws	Kepler's Law I	1 meeting
		Kepler's Law II	1 meeting
		Kepler's Law III	1 meeting
		Test of Cycle 2	1 meeting

The data collected in this research were learning activities, concept mastery, generic science skills (GSS), and students' responses. The data types, methods, instruments and time of data collection are presented in Table 2.

Table 2. Data Types, Methods, Instruments, and-Data Collection Time

Data Types	Methods	Instruments	Data collection time
Concept mastery	Objective test	Multiple choices	The end of the cycle
GSS	Objective test	Multiple choices	The end of the cycle
Learning activities	Observation	Observation guidance	During the learning process
Response	Questionnaire	questionnaire	The end of the second cycle

Furthermore, the data of Earth and Space Science concept mastery and GSS were analyzed descriptively and the conclusion was drawn based on the criteria in the assessment guidelines set in the Physics Education Department FMIPA Universitas Pendidikan Ganesha, while the qualifications employed are displayed in Table 3.

Table 3. The Guidelines for Students' Conversion Concept Mastery and GSS

Score Interval	Concept Mastery Category	GSS Category
85.0 - 100.0	Very good	Very high
70.0 - 84.9	Good	High
55.0 - 69.9	Sufficient	Sufficient
40.0 - 54.9	Low	Low
0 - 39.9	Very low	Very low

The success was defined as having 'good' concept mastery and 'high' generic science skills.

The students' responses to the implemented learning model were described on the basis of the ideal average score and ideal standard deviation. The questionnaire responses consisted of 15 indicators, 5 maximum score and 1 minimum score each. Moreover, the classification of the students' responses is as in Table 4.

Table 4. The Conversion Score of the Students' Responses

Interval	Score Interval	Qualification
$> (\bar{x}_i + 1.5 s_i)$	> 60	Very positive
$(\bar{x}_i + 0.5 s_i) - (\bar{x}_i + 1.5 s_i)$	50 - 60	Positive
$(\bar{x}_i - 0.5 s_i) - (\bar{x}_i + 0.5 s_i)$	40 - 50	Sufficient
$(\bar{x}_i - 1.5 s_i) - (\bar{x}_i - 0.5 s_i)$	30 - 40	Negative
$< (\bar{x}_i - 1.5 s_i)$	< 30	Very negative

\bar{X}_i = mean score; s_i = standard deviation.

The success was defined as having 'positive' responses.

Table 5. The Student Activities

No	Aspects Observed	Cycle 1		Cycle 2	
		Score	%	Score	%
Student – student interaction					
1	The students discuss in groups	9	75.00	11	91.67
2	The students conduct inter-group discussions	7	58.33	7	58.33
3	The students communicate their analytical results about Ranking Task Exercises(RTE)	8	66.67	10	83.33
4	The students refute the statement expressed by other students	6	50.00	6	50.00
5	The students are self-employed in analyzing RTE	3	25.00	2	16.67

RESULTS AND DISCUSSION

Learning Description

In the cycle 1 and 2, the learning was performed using the collaborative ranking task (CRT) model comprising five phases, which were (1) dealing with problems; (2) testing data collection; (3) testing through experiment; (4) formulation; and (5) concept application. The activities in the five phases were: (1) the lecturer explored the initial ideas of the students related to the topic being studied by asking questions and assigning students to create hypotheses connected to the proposed questions; (2) the lecturer assigned the students to collect information linking with the problems encountered through various sources; (3) the lecturer facilitated the students in conducting testing activities against hypotheses proposed through experiments, demonstrations, and collaborative group discussions, facilitated by ranking task exercises (RTE); (4) the lecturer guided the students to conduct class discussions dealing with the results of the investigation, the students drew conclusions about the results of observations they have done and had reflections on the development of learning; and (5) The students solved the problems in groups.

The Earth and Space Science course with the collaborative ranking task was described by the observation results on the learning activities. The student activities were observed from student-student interaction and student-teaching materials interaction, while the lecturer activities were observed from the student-lecturer interaction and lecturer-teaching materials interaction. The results of student activity observation in the cycle 1 and 2 appear in Table 5.

6	The students imitate / rewrite the results of RTE analysis	3	25.00	3	25.00
Student – teaching materials interaction					
1	The students record the material submitted	6	50.00	7	58.33
2	The students use reference books in their learning process	9	75.00	6	50.00
3	The students use multimedia animation in their learning process	6	50.00	10	83.33
4	The students learn the RTE before working on it	9	75.00	11	91.67
5	The students build a pattern of understanding RTE	7	58.33	8	66.67
6	The students express the concepts based on the results of RTE analysis	6	50.00	7	58.33

In the cycle 1, it found that the student activities of group discussion (A1), and learning about the ranking task exercises (B4) obtained the highest score. The students were hectic but rarely found working individually in analyzing the RTE and imitating/rewriting the RTE analysis results. Things lacking in the cycle 1 were then improved,

suggesting that the students worked more collaboratively. With these improvements, the students' activities in the cycle 2 for group discussion and RTE prior knowledge showed an increase, while the individual acts in analyzing had the lowest score. The result of lecturer activity observation in cycles 1 and 2 is shown in Table 6 below.

Table 6. The Lecturer Activities

No	Aspects observed	Cycle 1		Cycle 2	
		Score	%	Score	%
Lecturer – student interaction					
1	The lecturer asks questions	3	17.65	4	21.05
2	The lecturer helps the group discussion	3	17.65	3	15.79
3	The lecturer gives appreciation	2	11.76	3	15.79
4	The students pay attention	3	17.65	2	10.53
5	The students answer the question	3	17.65	3	15.79
6	The students ask questions	3	17.65	4	21.05
	Average A	2.83		3.17	
Lecturer – teaching materials interaction					
1	The lecturer informs the materials	2	18.18	2	20
2	The lecturer communicates the materials	3	27.27	3	30
3	The lecturer demonstrates the visual media	3	27.27	3	30
4	The lecturer interpreted the instrument of Ranking Tasks Exercises (RTE)	3	27.27	2	20
	Average B	2.75		2.5	

Based on Table 6, the lecturer activities during the learning in the cycle 1 for lecturer-students interaction aspect has not gone well. The students tended to pay attention to the lecturers' explanations. This was because the students did not understand the tasks pattern presented in the RTE. Therefore, in the cycle 2, the improvement was done by directing the students to work on the provided RTE. With this improvement, in the cycle 2, lecturer-students interactions were likely to be dominated by asking and answering questions. While the students' activity in listening to the explanation of the lecturer tended to decline.

This happened because the students focused on the RTE directives. By intensifying the implementation of ranking task based on the weakness in the cycle 1, the lecturer activities in the cycle 2 have improved.

From the results of the learning reflection in the cycle 2, there were several things that still needed improvement for the next learning, they were: (1) optimizing the planning and implementation of learning model ranking task; (2) emphasizing the concept transferring; and (3) designing contextual ranking task exercises to create a more interesting and easily-understood learning.

Concept Mastery

The Mastery of concepts was excavated using multiple choice tests related to the Phase of the Moon concept and Kepler's Law. The achievement of concept mastery in cycle 1 and 2 is presented in Table 7.

Table 7. The Achievement of Concept Mastery

Score Interval	Cycle 1		Cycle 2		Criteria
	f	%	f	%	
85.0–100	0	0	0	0	Very good
70.0 - 84.9	2	8	7	28	Good
55.0 - 69.9	4	16	14	56	Sufficient
40.0 - 54.9	11	44	4	16	Low
0 - 39.9	8	32	0	0	Very low
Total	25	100	25	100	
Average	50		64		
Standard deviation	11.4		8.3		

f = observation frequency

Seen from the table above, the average of concept mastery in the cycle 1 was 50 and categorized as 'low'. After the cycle 2 learning, the average of the students' concept mastery of the Earth and Space Science increased to 64, or in the 'sufficient' category. This meant that there was an increase in the student achievement of concept mastery after learning using collaborative ranking task but has not reached the established success criteria.

This increase was due to the implementation of the collaborative ranking task exercises model which turned on the learning atmosphere. The RTE made the students organized the clear pattern of the materials, resulting in a regular assimilation and accommodation. This contributed greatly to the students' concept mastery level, as von Glaserfeld (Matlin, 2003) suggested that knowledge does not reflect objects to logical reality, but rather the organization of words derived from the existed experiences. Thus, the RTE could affect the students' concept mastery achievement level.

In addition, the improvement of the students' concept mastery, independent thinking, and social knowledge building were the results of discussions with collaborative RTE. This finding is in line with Vygotsky's (Oakley, 2004) theory of knowledge and the findings of Hadwin & Oshige, (2011), who stated that the result of collaborative learning is the formation of learning societies, where students become more in-

dependent, articulate, and mature socially and mentally. Independent thinking is the main goal of transformational learning (Flores et al., 2012). Hence, the RTE could affect the achievement level of college students' conceptualization. The findings of this study are in full agreement to that of Akan & Dinçer (2014).

Generic Science Skills

The generic science skills (GSS) measured in this study comprised 5 (five) types of skills, namely indirect observation, symbolic language, logical inference, principle-based logical framework, and concept building. The GSS profiles achieved in the cycle 1 and cycle 2 are presented in Table 8.

Table 8. Students' Generic Science Skills Profiles

Interval	Cycle 1		Cycle 2		Criteria
	f	%	f	%	
85.0–100	0	0	0	0	Very high
70.0-84.9	4	16	7	28	High
55.0-69.9	12	48	14	56	Sufficient
40.0-54.9	7	28	4	16	Low
0-39.9	2	8	0	0	Very low
Total	25	100	25	100	
Average	58.4		62.8		
Standard deviation	13.3		10.2		

f = observation frequency

Hinge on Table 6, the average score of generic science skills in the cycle 1 was 58.4 and belonged to 'sufficient' category. In the cycle 2, the average became 62.8 and still in the same category. Numerically, the average students' GSS score indicated an increase but has not yet reached the established criteria.

The increase of GSS average from the cycle 1 to cycle 2 was due to the lecturing process adopting such model which gave the students' opportunity to interact with the materials presented chronologically. Extensive access to the students interacting with the teaching materials has provided a social environment that plays a major role in their building knowledge process (Oakley, 2004; Freudenberg, et al., 2011).

The failure of GSS set out in the cycle 2 could be elucidated by the findings of the observations during the learning process, in which the learning process in the cycle 2 was not optimally done. It took sufficient time to habituate learning with the CRT model for both students and lectu-

ners. Therefore, the planning and learning implementation required to be optimized. This is in line with the findings of Purwoko et al. (2017); Wijaya (2009); and Pujani (2013), that the improvement of teachers' competence in preparing the learning could significantly enhance students' learning activities and thinking skills. The performance of the GSS indicators is illustrated by the graph in Figure 2.

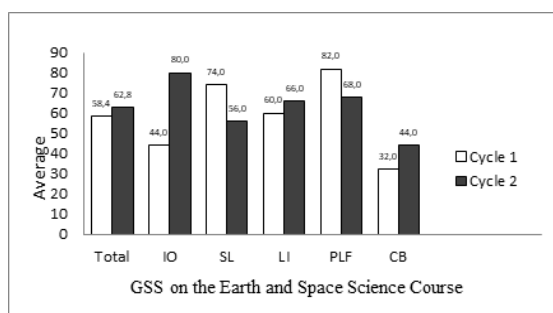


Figure 2. The Performance of the GSS Indicators

Figure 2 indicates that the indirect observation (IO), logic inference (LI), and concept building (CB) have increased from the cycle 1 to cycle 2. However, there were also decreasing indicators from the cycle 1 to cycle 2, which were the symbolic language (SL), and principle-based logical framework (PLF). The highest increase occurred in the indirect observation (IO) and the lowest on the concept building (CB) indicator.

Seeing from the GSS indicators achievement, not all of them were well-developed. Each indicator's accomplishment showed that the increase of GSS only fell on three skills, namely indirect observation, logical inference, and concept building. This was due to the different material characteristics in each cycle, thus, the developed Generic Science Skills also varied. This is aligned with the findings of the research conducted by Mulyani et al. (2016); Wahyuni (2016); and Amida (2017).

The decreasing indicators of the principle-based logical framework and symbolic language were probably caused by the insufficient learning time so that the students were lack of opportunity and flexibility to hone the process of scientific methods in learning. Through the Generic Science Skills, the students would be accustomed to scientific thinking that supports the understanding of their concept and thinking skills (Siswanto et al., 2016 and Brotosiswoyo, 2000). Moreover, the decreasing achievement on both indicators likely occurred because the skills indicator was represented by only a number on the instrument used so that the obtained results can-

not be further generalized.

Therefore, the collaborative RTE implementation has provided interaction and cooperation for college students to build knowledge based on personal experience so as to give more meaning to the learning process. This is believed to increase the students' concept mastery and generic science skills. These findings are fully in accordance with that of Maknun (2015); Wahyuni (2016); Mulyani (2016); and Amida (2017).

The Students' Responses

The students' responses to the Earth and Space Science Course with collaborative ranking task model were investigated through questionnaires given at the end of cycle 2. The analysis found the mean response score of 58.6; $s = 6.7$, having '**positive**' qualification. The distribution of the students' responses is presented in Table 9.

Table 9. The Distribution of the Students' Responses

Score Interval	Frequency	Percentage (%)	Category
> 60	11	44	Very positive
50 - 60	11	44	Positive
40 - 50	2	8	Sufficient
30 - 40	1	4	Negative
< 30	0	0	Very negative

The revealed responses implied how the students adapted to the lecture using the collaborative ranking task. In this case, the ranking task exercises made it easier for students to understand the materials, generated interesting activities, triggered curiosity, facilitated group discussion, and built the students' independence in concept mastery and generic science skills.

Based on the findings and discussions of this study, it is suggested that the teachers/lecturers of the Earth and Space course in the Teacher Training Institutes and Junior/Senior High Schools try to implement the collaborative ranking task learning model as an alternative in Physics learning to vary lecturing activities and improve the concept mastery and generic science skills. The collaborative RTE provided interaction and cooperation for students to earn knowledge based on their personal experiences so as to give signification in the learning process. The positive responses from the students also supported the achievement of these research objectives. Building a positive attitude during learning supported the achievement of the expected goals.

CONCLUSION

Based on the data analysis results and findings in the development of this research, several conclusions could be drawn up. First, the implementation of the collaborative ranking-task model could improve the students' concept mastery of the Earth and Space Science starting from the 'low' category of ($\bar{x}_1 = 50$) to 'sufficient' category of ($\bar{x}_2 = 64$). Second, the generic science skills have numerically increased to the 'sufficient' category ($\bar{x}_1 = 58.4$, $\bar{x}_2 = 62.8$). The developed GSS indicators were indirect observation, logic inference, and concept building.

ACKNOWLEDGEMENTS

The authors would like to thank to the Dean of Mathematics and Natural Sciences Faculty, Universitas Pendidikan Ganesha (Undiksha) for the financial support. We also appreciate the assistance of teaching staff at Physics Education Department, Undiksha.

REFERENCES

- Aktan, D. Ç., & Dinçer, E. O. (2014). Examination of Preservice Science Teachers' understanding Levels of Kepler's Laws with Ranking Task Questions. *Journal of Baltic Science Education*, 13(2), 276-288.
- Amida, N., & Supriyanti, F. M. T. (2017). Experiment of Enzyme Kinetics Using Guided Inquiry Model for Enhancing Generic Science Skills. *Journal of Physics: Conference Serie*, 812(1), 12-22.
- Anwar, M. (2014). The Effect of Active-Cooperative Learning on Science Generik Skills of Student in Chemical Kinetics Course for Prospective Teachers. *Journal of Education and Practice*. 5(1), 149-154.
- Arends, R. L. (2007). *Learning To Teach*. 9 Ed. Singapura: McGrawHill Higher Education.
- Brotosiswoyo, B. S. (2000). Hakikat Pembelajaran Fisika di Perguruan Tinggi. *Proyek Pengembangan Universitas Terbuka*. Jakarta: Direktorat Jendral Perguruan Tinggi, Depdiknas.
- Duschl, R. A., & Grandy, R. (2013). Two views about explicitly teaching nature of science. *Science & Education*, 22(9), 2109-2139.
- Flores, K. L., Matkin, G. S., Burbach, M. E., Quinn, C. E., & Harding, H. (2012). Deficient critical thinking skills among college graduates: Implications for leadership. *Educational Philosophy and Theory*, 44(2), 212-230.
- Fraknoi, A. (2011). Seven Concepts for Effective Teaching. *Astronomy Education Review*, 10(1), 3-5.
- Freeman, S., Eddy, S. L., McDonough, M., Smith, M. K., Okoroafor, N., Jordt, H., & Wenderoth, M. P. (2014). Active Learning Increases Student Performance in Science, Engineering, and Mathematics. *Proceedings of the National Academy of Sciences*, 111(23), 8410-8415.
- Freudenberg, B., Brimble, M., & Cameron, C. (2011). WIL and Generic Skill Development: The Development of Business Students' Generic Skills Through Work-Integrated Learning. *Asia-Pacific Journal of Cooperative Education*. 12(2), 79-93.
- Gibb, J. (2002). The Collection of Research Reading on Generic Skill in VET. Retrieved from: <http://www.ncvr.edu.au/htm>. [17 Nopember 2008].
- Hadwin, A., & Oshige, M. (2011). Self-regulation, co-regulation, and socially shared regulation: Exploring perspectives of social in self-regulated learning theory. *Teachers College Record*, 113(2), 240-264.
- Harahap, S.P.R., Sani, R. A. & Simanjuntak, M. P. (2017). Effect of Scientific Inquiry Learning Model on the Student's Generic Science Skill. *IOSR Journal of Research & Method in Education (IOSR-JRME)*. 7(4), 60-64.
- Henderson, C., Dancy, M., & Niewiadomska-Bugaj, M. (2012). Use of research-based instructional strategies in introductory physics: Where do faculty leave the innovation-decision process?. *Physical Review Special Topics-Physics Education Research*, 8(2), 20-54.
- Hudgins, D. W., Prather, E. E., Grayson, D. J., & Smits, D. P. (2008). Effectiveness of Collaborative Ranking Tasks on Student Understanding of Key Astronomy Concepts. *Astronomy Education Review*, 5(1), 1-22.
- Kemis, S. & McTaggart, R. (1982). *The Action Research Planner*. Deakin University Press.
- Lelliott, A., & Rollnick, M. (2010). Big ideas: A Review of Astronomy Education Research 1974-2008. *International Journal of Science Education*, 32(13), 1771-1799.
- Maknun, J. (2015). The Implementation of Generative Learning Model on Physics Lesson to Increase Mastery Concepts and Generic Science Skills of Vocational Students. *American Journal of Educational Research*, 3(6), 742-748.
- Matlin, M. W. (2003). *Cognition (Fifth Edition)*. New York: John Wiley & Sons, Inc.
- Mulyani, S., Liliyasi, L., Wiji, W., Hana, M. N., & Nursadad, E. (2016). Improving Students' Generic Skill in Science through Chemistry Learning Using Ict-Based Media on Reaction Rate and Osmotic Pressure Material. *Jurnal Pendidikan IPA Indonesia*, 5(1), 150-156.
- Oakley, L. (2004). *Cognitive Development*. New York: Routledge.
- Ogan-Bekiroglu, F. (2014). Effects of Model Based Teaching on Preservice Physics Teachers' Conceptions of the Moon, Moon Phases, and Other Lunar Phenomena. *International Journal of Science Education*. 29(5), 555-593.
- Pujani, N. M. (2013). Pengembangan Keterampilan Laboratorium Astronomi Berbasis Kemam-

- puan Generik Sains Bagi Calon Guru Fisika. *Jurnal Pengajaran MIPA*, 18(2), 230-239.
- Purwoko, A. A., Andayani, Y., Muntar, M., & Diartha, I. N. (2017). Efforts in Improving Teachers' Competencies Through Collaboration between Teacher Forum on Subject Matter (MGMP) and Pre-Service Teacher Training Institution (LPTK). *Jurnal Pendidikan IPA Indonesia*, 6(1), 11-15.
- Pursitasari, I. D., & Permanasari, A. (2012). Analisis Pemahaman Konsep dan Kesulitan Mahasiswa untuk Pengembangan Program Perkuliahan Dasar-dasar Kimia Analitik Berbasis Problem solving. *Jurnal Pendidikan IPA Indonesia*, 1(1), 98-101
- Saprudin, Sutarno, & Liliyasi. (2010). Developing Generic Science Skill of Prospective Teacher through Offline and Online Interactive Multi Media in Physics Learning. *Proceedings of The 4th International Conference on Teacher Education; Join Conference UPI & UPSI Bandung, Indonesia*, 8-10 November 2010.
- Siswanto, J., Saefan, J., Suparmi, S., & Cari, C. (2016). The Effectiveness of E-Lab to Improve Generic Science Skills and Understanding The Concept of Physics. *Jurnal Pendidikan Fisika Indonesia*, 12(1), 33-40.
- Wahyuni, I., & Amdani, K. (2016). Influence Based Learning Program Scientific Learning Approach to Science Students Generic Skills. *Journal of Education and Practice*, 7(32), 104-108.
- Wambugu, P. W., & Changeiywo, J. M. (2008). Effects of Mastery Learning Approach on Secondary School Students' Physics Achievement. *Eurasia Journal of mathematics, Science & technology education*, 4(3), 15-36.
- Wijaya, A. F. C. (2012). Collaborative Ranking Tasks (CRT) To Improve The Mastery Of Earth And Space Science Concept For Prospective Physics Teachers. *Proceedings of the Third International Seminar on Science Education Challenging Science Education in the Digital Era*. UPI Bandung. Indonesia.
- Wijaya, A. F. C., & Ramalis, T. R. (2012). Collaborative Ranking Tasks (CRT) Berbantuan e-learning untuk Meningkatkan Keterampilan Generik Sains Mahasiswa Calon Guru Fisika. *Jurnal Pendidikan Fisika Indonesia*, 8(2), 144-151.



DESIGN AND CHARACTERIZATION OF LOW-COST SENSORS FOR AIR QUALITY MONITORING SYSTEM

R. Rumantri*¹, M. Y. N. Khakim², I. Iskandar³

^{1,2,3}Departement of Physics, Faculty of Mathematics and Natural Sciences, Sriwijaya University

DOI: 10.15294/jpii.v7i3.14444

Accepted: May 22nd 2018. Approved: February 15th 2018. Published: September 20th, 2018

ABSTRACT

In this study, low-cost sensors for air quality monitoring system have been characterized and designed. These sensors are applied in a monitoring system and installed at Sriwijaya University, which is vulnerable to the impacts of forest fires in the surrounding area. This monitoring system will provide information especially for the university community to determine the level of air quality on campus. In this research the researchers focussed on the characterization and design of system sensor that aimed to get the best configuration of low-cost sensors namely MQ-7, Sharp GP2Y1010AU0F and own-designed smoke sensor to have high reliability and effectiveness to be applied to monitoring systems. The test results showed that the sensors have good response and sensitivity. Therefore, it can be applied to the monitoring system to provide information about the level of particle concentration, carbon monoxide and smoke which meet the needs of low-cost monitoring systems.

© 2018 Science Education Study Program FMIPA UNNES Semarang

Keywords: air quality, arduino, carbon monoxide, particulate, sensor

INTRODUCTION

An air quality level depends on balanced gas compositions in the air. According to Indonesian Air Pollutant Standard Index (ISPU) there are some pollutants affecting the air quality, such as particulate matter (PM), carbon monoxide gas (CO), sulfur dioxide (SO₂), nitrogen dioxide (NO₂), ozon (O₃). If one of this pollutant exceeds their threshold, it could influence human health (Goldstein, 2008; Brook et al., 2010; Goudarzi et al., 2014; Guo et al., 2014). As a developing country, Indonesia has an air pollution problem, not only from industry and vehicle emission, but also from a forest fire. The forest fire in 2015 burnt 2.6 million hectares (Purnomo et al., 2017) and became a source of various type air pollutant (Pribadi & Kurata, 2017).

Sriwijaya University is one of the universities that directly affected the land and forest fires. This is because the location is surrounded by peat lands where the fire disaster occurs. In addition to financial losses, the haze that occurs also disrupts health and campus activities. Therefore, a monitoring system is needed that can provide information and warnings about the level of air quality.

The monitoring system of air quality levels is required not only for precaution but also for awareness to protect and keep our air clean. Unfortunately, in the market most of the monitoring system is expensive and difficult to maintain (Kumar et al., 2015) the impacts of very high but temporally and spatially restricted pollution, and thus exposure, are still poorly understood. Conventional approaches to air quality monitoring are based on networks of static and sparse measurement stations. However, these are prohibitively expensive to capture tempo-spatial

*Correspondence Address
E-mail: rizkirumantrissi@gmail.com

heterogeneity and identify pollution hotspots, which is required for the development of robust real-time strategies for exposure control. Current progress in developing low-cost micro-scale sensing technology is radically changing the conventional approach to allow real-time information in a capillary form. But the question remains whether there is value in the less accurate data they generate. This article illustrates the drivers behind current rises in the use of low-cost sensors for air pollution management in cities, while addressing the major challenges for their effective implementation (Kumar et al., 2015). The recent emergence of low-cost sensors allows us to build a low-cost system that can be a solution for air pollution management. Although the ability may not as good as expensive measurement devices, the sensors can be an alternative for wide application in air quality level measurement. In this study, low-cost sensors are characterized to build an air quality monitoring system. The system has basic measurements for air quality level including carbon monoxide gas and particulate matter. The monitoring system is installed at Sriwijaya University and will be used as an early warning system related to bad air quality level for students and people who live in Sriwijaya University.

METHODS

Monitoring System Design

This air quality monitoring system consists of a microcontroller with 3 sensors namely carbon monoxide sensor, particulate matter sensor, and smoke sensor. This system is also equipped with a data logger to store measurement data and LCD to display the level of air quality. The block diagram of the air quality monitoring system is shown in Figure 1.

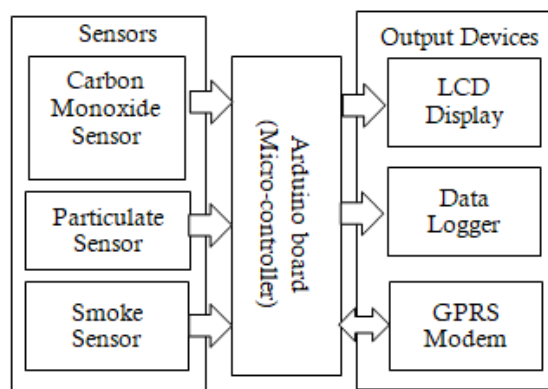


Figure 1. Block Diagram Air Quality Monitoring System

Arduino is used as a processing and controlling device. In addition 10 bits of analog to digital converter (ADC) integrated on arduino is used to convert analog signals from the sensors into physical quantities as measurement data. The data will be displayed on the LCD display, stored in the data logger and sent to the website via GPRS modem.

Particulate and Smoke Sensor

Exhaust gas emissions from fossil-fueled vehicles contribute to particulate matter levels in the air (Gentner et al., 2017; McDonald et al., 2015). Particulate measurements are important because the effects of particulate exposure could affect human health even if exposed for a long time (Brook et al., 2010; Guo et al., 2014; Kim et al., 2015; Turner et al., 2011; Wallwork et al., 2017).

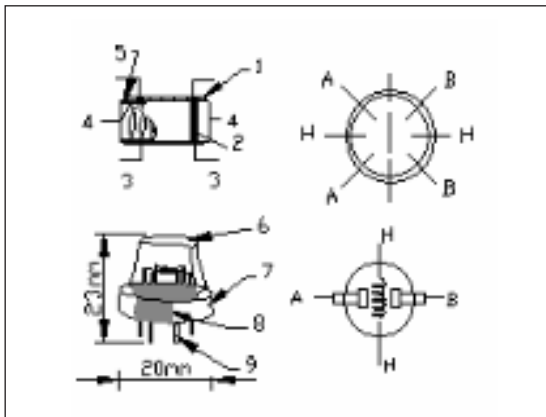
There is low-cost optical based particulate sensor available on the market such as PPD42NS (Shinyei Inc.) and DSM501A (Samyoung Inc.). However GP2Y1010AU0F (Sharp Corp.) has better performance (Wang et al., 2015). Sharp GP2Y1010AU0F is an optical-based sensor, which is used to detect dust or particulate matter in the air. This sensor consists of a phototransistor and infrared led, it has a compact size and simple to apply in a wide application. This sensor can detect particulate concentration in mg/m^3 . In addition, we also design smoke sensors with simple components consisting of infrared LED and photodiodes. This sensor is used to detect smoke concentration from a safe level of danger.

Carbon Monoxide Sensor

Carbon monoxide gas is a pollutant that is harmful to humans (Goldstein, 2008; Goudarzi et al., 2014; Levy, 2015), this gas is colorless and odorless, most of it comes from vehicle exhaust (Gentner et al., 2017; McDonald et al., 2015). Measuring the level of carbon monoxide gas is very important considering this pollutant is a common contaminant in the air.

There are several low-cost carbon monoxide sensors; the easier one to find in the market is MQ-7. This sensor also has been widely used in several studies (Bakri et al., 2015; Guohua et al., 2012; Kim et al., 2014; Tian et al., 2017). It has good sensitivity, long life and simple wiring circuit. From manufacturer technical data, this sensor can detect carbon monoxide concentration from 20 to 2000ppm. However, the output signal of this sensor is still in the form of a voltage that needs to be calibrated and converted to concentration in ppm unit. The structure and configuration

on of the MQ-7 gas sensor can be seen in Figure 2. The sensor consists of a micro Al_2O_3 ceramic tube, a sensitive layer of tin dioxide (SnO_2) and Nickel-Chromium alloys as a heater coil. This sensor has 6 pins, 4 pins for signal and electrodes, 2 pins for heating coils.



Information

Parts	Materials
1 Gas sending layer	SnO_2
2 Electrode	Au
3 Electrode line	Pt
4 Heater coil	Ni-Cr alloy
5 Tubular ceramic	Al_2O_3
6 Anti-explosion network	Stainless steel gauze (SUS316 100-mesh)
7 Calmp ring	Copper plating Ni
8 Resin base	Bakelite
9 Tube pin	Copper plating Ni

Figure 2. The Structure of MQ-7 Sensor (Hanwei Electronics co., ltd)

Sensor Characterization

Characterization of sensors is done to get the conversion value of the sensors output signal in the form of a voltage into the physical quantity that will be used in the algorithm of the monitoring system program.

Many studies have evaluated and characterized the Sharp GP2Y1010AU0F sensor comprehensively (Li & Biswas, 2017; Marinov et al., 2017; Wang et al., 2015). In this study, we use Sharp GP2Y1010AU0F technical data and linear regression of the characteristic graph of the sensor to be able to determine the conversion of the sensor signal in the form of voltage into mg / m^3 .

For calibrating the MQ-7 sensor besides technical data, we used a Dekko FM-7910 carbon monoxide meter as a reference. There are many methods and algorithms that have been developed and studied in calibrating low-cost gas sensors (Spinelle et al., 2015) including linear/multi linear regression and supervised learning techniques are compared. A cluster of ozone, nitrogen dioxide, nitrogen monoxide, carbon monoxide and carbon dioxide sensors was operated. The sensors were either of metal oxide or electrochemical type or based on miniaturized infra-red cell. For each method, a two-week calibration was carried out at a semi-rural site against reference measurements. Subsequently, the accuracy of the predicted values was evaluated for about five months using a few indicators and techniques: orthogonal regression, target diagram, measurement uncertainty and drifts over time of sensor predictions. The study assessed if the sensors were could reach the Data Quality Objective (DQOs, but in this study we use a simple method with the linearity of the gas concentration as measured against the response given by the sensor. By finding sensor resistance in different carbon monoxide gas concentration and curve fitting method we will get the polynomial equation to determine carbon monoxide gas concentration in *part per million* (ppm) unit.

Measurement Chamber

Sensors are placed on the measurement chamber in order to protect sensors from the directly open environment. The design of the measurement chamber is shown in Figure 3. Exhaust fan is applied to make air circulation in the chamber and to enhance data quality of sharp GP2Y1010AU0F (Wang et al., 2015). Besides as a sensor housing, in this experiment the chamber is used as the sensor characterization and test.

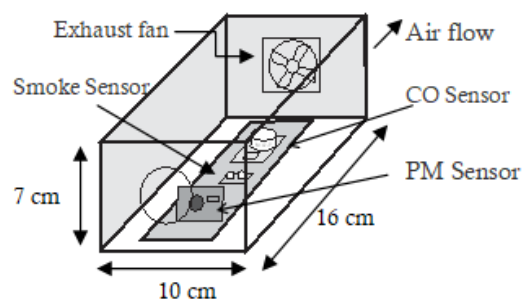


Figure 3. Measurement Chamber Design
Sensor testing is done by exposing the sensor with

a pollutant source through the measuring chamber to find out the response and sensitivity of the sensor. Especially for the MQ-7 sensor, the test is carried out on the measuring tube because the measurement is carried out with a predetermined concentration.

RESULTS AND DISCUSSION

Particulate and Smoke Sensor Characterization

According to Sharp GP2Y1010AU0F technical data, this sensor works with a pulse-driven wave to turn infrared LED on and off. In one cycle for 10 ms (i.e. 0.32 ms to turn infrared LED on and then 9.68 ms to turn the LED off). This sensor has a sampling time of 0.28 ms when the LED is on.

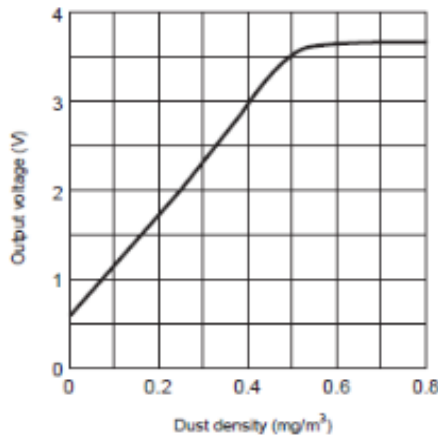


Figure 4. Sharp GP2Y1010AU0F Characteristic (Sharp Corp.).

From characteristic in Figure 4, the sensor has a linear relation between output and input i.e., particulate matter concentration of 0 – 0.5 mg/m³ as inputs resulting in the output voltage of 0,6-3.5 volt. Therefore, this linear regression for the relationship between particulate concentrations with sensor signal output can be obtained by using Equation (1).

$$x=0,16y-0,1 \quad (1)$$

where x is particulate concentration and y is the sensor signal voltage. However, the Equation (1) has been limited to calculate sensor signal voltage up to 3,5 volt for easy unit conversion. Anyways 3,5 volt is represented 0.5 mg/m³ of particulate concentration which is danger level according to standard pollutant index in Indonesia (ISPU).

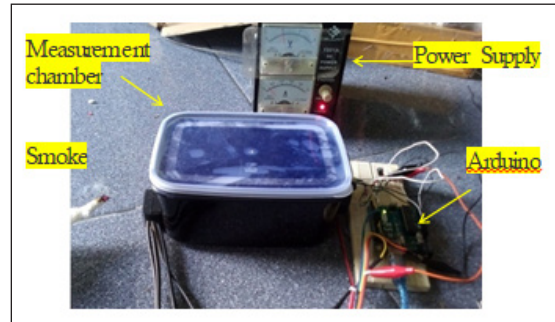


Figure 5. The Particulate and Smoke Sensor Test Process

To ensure sensor has the same characteristic with Figure 4, Sharp GP2Y1010AU0F is tested with smoke from burning paper and the test result (Figure 6) shows output voltage of this sensor increases along with higher particulate concentration. Meanwhile, it has the output voltage between 0.5 volt to 0.85 volts in the clean air this can be caused by the lowest detection limit of the sensor, besides that the maximum output voltage is 3,77 volt when it is exposed. This means that the sensor has good sensitivity and same characteristic as Figure 4.

The designed smoke sensor was placed on measurement chamber and was exposed directly to smoke for obtaining minimum and maximum voltage outputs of the sensor (Figure 5). At the time of testing, there is an error signal reading this is because the infrared ray smoke sensor bounces off the chassis that result in inconsistent measurement. Due to scattering reflection being able to disturb sensor sensitivity, this chamber uses a black color case to absorb infrared light.

This sensor works with 5 volt voltage power supply, however from the test result voltage signal output is about 0,53 - 2,04 volt. This range is divided into three levels i.e., (<1 volt) for safe level, (1 – 1,5 volt) for warning level, and (>1,5 volt) for danger level. From the testing, we show that the characteristic of the designed smoke sensor is comparable to the commercial sensor (sharp GP2Y1010AU0F) as shown in Figure 6. It also showed a good sensitivity to smoke exposure.

The designed smoke sensor has a lower measurement limit compared to sharp GP2Y-1010AU0F due to differences in sensor manufacturing. The smoke sensor is not equipped with a focusing lens and signal amplifier. This is because the smoke sensor is only designed to detect smoke.

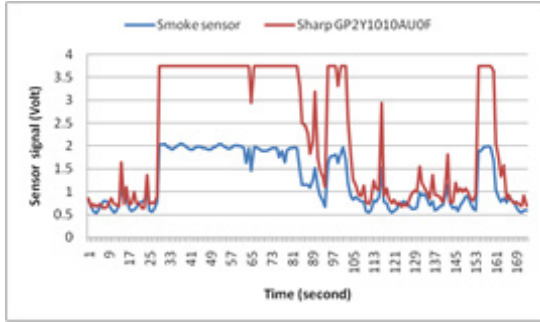


Figure 6. The Particulate and Smoke Sensor Test Result

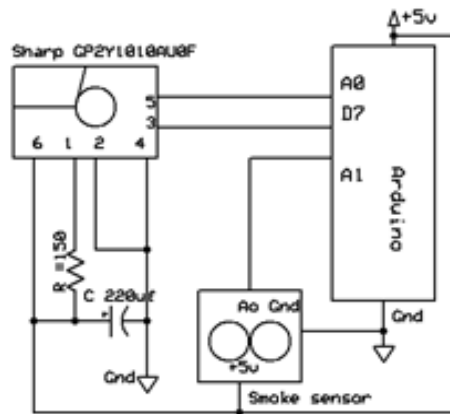
Carbon Monoxide Sensor Characterization

In its application the signal pin (pin 5) and LED signal (pin 3) of the sharp GP2Y-1010AU0F sensor will be connected to the analog and digital arduinopin, while the smoke sensor Analog out pin (Ao) is connected to the arduino analog input pin (A1). in detail the wiring of the particulate sensor and the smoke sensor is shown in Figure 7a.

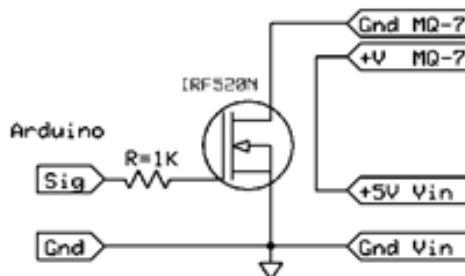
In this research we used the MQ-7 sensor in default manufacturer circuit with resistance

load (RL) about 1 KΩ, although on recommended technical data between 5KΩ-47KΩ, it is intended that in replacement of components do not need to modify the circuit. Before calibrating the sensor, it kept preheating over 48 hours according to the technical data. This sensor has two heating cycles that are high and low heating with alternating work.

The sensor has supplied with 5 volt power for 60 seconds during the high heating cycle and the sensor takes air sample for measuring carbon monoxide concentration. Otherwise, when low heating cycle, the sensor is supplied by 1,4 volts power for 90 seconds and surface resistance of the sensor resulting from the sampled air can be measured. The carbon monoxide concentration can be determined from the sensor resistance changes. Because this sensor requires 350mW of power consumption while the arduino cannot provide enough current, an external power source that is controlled by the driver circuit is needed. The design of the driver circuit is shown in Figure 7b



(a)



(b)

Figure 7. (a) Particulate and Smoke Sensor Wiring (b) Driver Circuit of the MQ-7 Sensor

The signal pin is connected to the micro-controller which will provide the pulse width modulation (PWM) signal so that the driver will supply the voltage based on the given signal. In this case, when the signal provided by the microcontroller of 0.5 volts then the driver will supply the sensor with a voltage of 1.4 volts, but when the signal is given a voltage of 5 volts then the driver will supply the sensor with full voltage (5 volts).

According to MQ-7 technical data, there are several parameters that must be known for calibrating the MQ-7 sensor. That is output signal sensor voltage (VRL), the surface resistance of the sensor (Rs), sensor resistance at 100ppm CO in the air (Ro), load resistance (RL) and sensor working voltage (Vc). Typical sensitivity characteristics of the MQ-7 for several gases are illustrated by the relationship between the resistance sensor ratio at various concentrations of gases (Rs) with the resistance sensor at 100ppm CO in the clean air (Ro) to the concentration of carbon monoxide gas.

From the characteristic Rs/Ro value will be 1 in 100 ppm gas carbon monoxide concentrations and it is a reference to convert the output voltage to ppm unit. So the relationship between Rs/Ro ratios with carbon monoxide concentration in ppm can be written as Equation 2.

$$Rs/Ro = 1 = 100ppm\ CO \quad (2)$$

Unfortunately Ro value is not clearly mentioned in technical data but the relationship between Rs and RL is described in Equation 3.

$$Rs/RL = \frac{(Vc-VRL)}{VRL} \quad (3)$$

Load resistance (RL) of the sensor in this research is 1 kilo Ohm as manufacture circuit default, so that Rs can be determined by using Equation 4.

$$Rs = (-1) RL \quad (4)$$

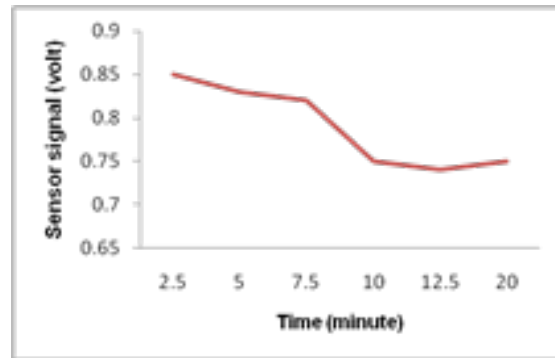
Therefore, to determine the value of Ro then the sensor should be tested to get the value of Rs when the concentration of Carbon monoxide gas is 100ppm.

In testing and calibrating process, sensor and reference measurement device are placed on measurement tube which has connected to motorcycle muffler. Motorcycle exhaust gas is used as a carbon monoxide source. Calibrating process is shown in Figure 8.

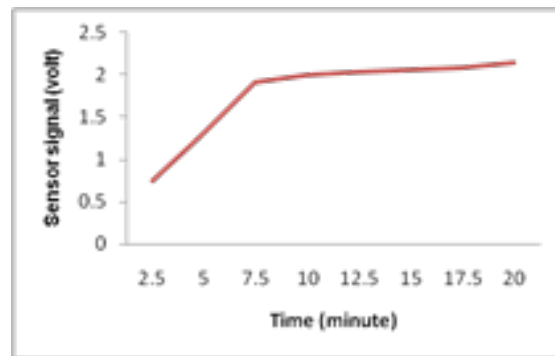


Figure 8. The Testing and Calibrating Process of MQ-7 Sensor.

From our test, the sensor output decreased from 0.85 and stable to 0.75 volts in clean air and open environment (Figure 14.a). Meanwhile, sensor output increased up to 2,15 volt when exposure by motorcycle exhaust gas (Figure 14.b). These results indicate that the sensor has a good response to carbon monoxide gas.



(a)

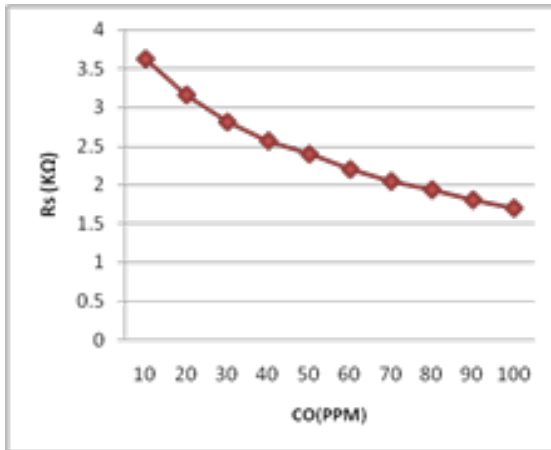


(b)

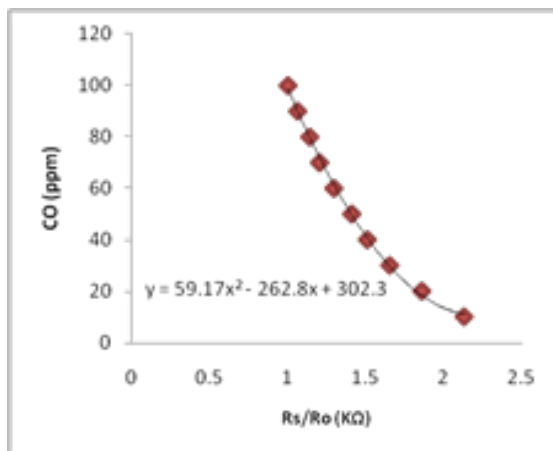
Figure 9. The Sensor MQ-7 Sensitivity Test Result (a) in Clean Air (b) Exposed by Motorcycle Gas Emission

The second test was conducted to find the relationship between the sensor resistance values (Rs) of changes in carbon monoxide gas concentration.

When exposed by motorcycle exhaust gas, R_s value is decreasing along with higher carbon monoxide concentration as shown in Figure 10.a. According to Equation (2), R_o value can be obtained from R_s value at 100 ppm carbon monoxide, from test result R_s value at 100 ppm carbon monoxide is 1,7K Ω as we can conclude that R_o value is also 1,7K Ω , where R_o is the value of the sensor resistance when the concentration of carbon monoxide gas is 100 ppm.



(a)



(b)

Figure 10. The Mq-7 Test Results (a) Relationship between R_s with CO Concentration.(b) R_s/R_o and CO Gas Concentrations.

However, from the technical data of the MQ-7 R_s value at 100ppm the concentration of carbon monoxide gas should be between 2-20K Ω . This could be due to the difference in RL value used, the researcher uses RL of 1 kilo ohm which is the default of the sensor manufacturer circuit. Other than that, the measurement uncertainty factor due to the influence of various parameters

can also make the carbon monoxide gas measurement results less precise (Spinelle et al., 2015) including linear/multi linear regression and supervised learning techniques are compared. A cluster of ozone, nitrogen dioxide, nitrogen monoxide, carbon monoxide and carbon dioxide sensors was operated. The sensors were either of metal oxide or electrochemical type or based on miniaturized infra-red cell. For each method, a two-week calibration was carried out at a semi-rural site against reference measurements. Subsequently, the accuracy of the predicted values was evaluated for about five months using a few indicators and techniques: orthogonal regression, target diagram, measurement uncertainty and drifts over time of sensor predictions. The study assessed if the sensors were could reach the Data Quality Objective (DQOs). In this case, for samples of motor vehicle exhaust compositions which also contain various hydrocarbon compounds and various nitrogen oxides (NO_x)(McDonald et al., 2015) are possible to influence the measurement of carbon monoxide.

With R_o value from the test, R_s/R_o ratio for another CO concentration can be obtained using Equation (2), R_s/R_o values from test result can be seen at Figure 10.b. R_s/R_o is decreased with higher carbon monoxide concentration, and match with sensor characteristic.

By using curve fitting method for R_s/R_o ratio in different CO gas concentration, we can get polynomial equation $y = 59.17x^2 - 262.8x + 302.3$, with x is R_s/R_o and y is carbon monoxide concentration in ppm. This equation can be used to determining various CO gas concentrations in ppm unit.

CONCLUSION

Low-cost sensors system for real time monitoring system has been designed and characterized. From the experiment, an MQ-7 sensor with factory default circuit configuration is able to detect carbon monoxide gas concentration with good sensitivity. Other than that from the test show the similarity of sensor characteristics of the test result with factory technical data which shows the relationship between R_s/R_o with carbon monoxide gas concentration in ppm. So the polynomial equation obtained can be used to determine the concentration of carbon monoxide gas. As a particulate sensor, although Sharp GP2Y1010AU0F less accurate in detecting particles <0,2mg/m³, this sensor has good sensitivity and can detect dust or particle concentration up

to 0,5 mg/m³. Moreover, the smoke sensor has a good sensitivity to smoke so that the sensor is capable of warning when forest fire happens in the surrounding area. According to ISPU in danger level the concentration of carbon monoxide and particulate matter is about 34 ppm and 0,42 mg/m³, respectively. This indicates that the sensors meet the minimum requirements for air quality measurement and can be applied to the air quality monitoring system to be installed at Sriwijaya University.

REFERENCES

- Bakri, N. A. M., Al Junid, S. A. M., Razak, A. H. A., Idros, M. F. M., & Halim, A. K. (2015). Mobile Carbon Monoxide Monitoring System Based on Arduino-Matlab for Environmental Monitoring Application. In *IOP Conference Series: Materials Science and Engineering* (Vol. 99, No. 1, p. 012009). IOP Publishing.
- Brook, R. D., Rajagopalan, S., Pope III, C. A., Brook, J. R., Bhatnagar, A., Diez-Roux, A. V., ... & Peters, A. (2010). Particulate Matter Air Pollution and Cardiovascular Disease: An Update to the Scientific Statement from the American Heart Association. *Circulation*, *121*(21), 2331-2378.
- Gentner, D. R., Jathar, S. H., Gordon, T. D., Bahreini, R., Day, D. A., El Haddad, I., ... & Goldstein, A. H. (2017). Review of Urban Secondary Organic Aerosol Formation from Gasoline and Diesel Motor Vehicle Emissions. *Environmental science & technology*, *51*(3), 1074-1093.
- Goldstein, M. (2008). Carbon Monoxide Poisoning. *Journal of Emergency Nursing*, *34*(6), 538-542.
- Goudarzi, G., Geravandi, S., Vosoughi, M., javad Mohammadi, M., & sadat Taghavi, S. (2014). Cardiovascular Deaths Related to Carbon monoxide Exposure in Ahvaz, Iran. *Iranian Journal of health, Safety and environment*, *1*(3), 126-131.
- Guo, S., Hu, M., Zamora, M. L., Peng, J., Shang, D., Zheng, J., ... & Molina, M. J. (2014). Elucidating Severe Urban Haze Formation in China. *Proceedings of the National Academy of Sciences*, *111*(49), 17373-17378.
- Guohua, H., Lvye, W., Yanhong, M., & Lingxia, Z. (2012). Study of Grass Carp (*Ctenopharyngodon Idellus*) Quality Predictive Model Based on the Electronic Nose. *Sensors and Actuators B: Chemical*, *166*, 301-308.
- Kim, J. Y., Chu, C. H., & Shin, S. M. (2014). ISSAQ: An Integrated Sensing Systems for Real-Time Indoor Air Quality Monitoring. *IEEE Sensors Journal*, *14*(12), 4230-4244.
- Kim, K. H., Kabir, E., & Kabir, S. (2015). A review of the Human Health Impact of Airborne Particulate Matter. *Environment International*, *74*, 136-143.
- Kumar, P., Morawska, L., Martani, C., Biskos, G., Neophytou, M., Di Sabatino, S., ... & Britter, R. (2015). The Rise of Low-Cost Sensing for Managing Air Pollution in Cities. *Environment International*, *75*, 199-205.
- Levy, R. J. (2015). Carbon Monoxide Pollution and Neurodevelopment: A Public Health Concern. *Neurotoxicology and Teratology*, *49*, 31-40.
- Li, J., & Biswas, P. (2017). Optical Characterization Studies of a Low-Cost Particle Sensor. *Aerosol and Air Quality Research*, *17*(7), 1691-1704.
- Marinov, M. B., Hensel, S., Ganev, B., & Nikolov, G. (2017, September). Performance Evaluation of Low-Cost Particulate Matter Sensors. In *Scientific Conference Electronics (ET), 2017 XXVI International* (pp. 1-4). IEEE.
- McDonald, B. C., Goldstein, A. H., & Harley, R. A. (2015). Long-Term Trends in California Mobile Source Emissions and Ambient Concentrations of Black Carbon and Organic Aerosol. *Environmental Science & Technology*, *49*(8), 5178-5188.
- Pribadi, A., & Kurata, G. (2017, January). Greenhouse Gas and Air Pollutant Emissions From Land and Forest Fire in Indonesia during 2015 based on Satellite Data. In *IOP Conference Series: Earth and Environmental Science* (Vol. 54, No. 1, p. 012060). IOP Publishing.
- Purnomo, H., Shantiko, B., Sitorus, S., Gunawan, H., Achdiawan, R., Kartodihardjo, H., & Dewayani, A. A. (2017). Fire Economy and Actor Network of Forest and Land Fires in Indonesia. *Forest Policy and Economics*, *78*, 21-31.
- Spinelle, L., Gerboles, M., Villani, M. G., Aleixandre, M., & Bonavitacola, F. (2015). Field Calibration of a Cluster of Low-Cost Available Sensors for Air Quality Monitoring. Part A: Ozone and Nitrogen Dioxide. *Sensors and Actuators B: Chemical*, *215*, 249-257.
- Tian, X., Lei, J., & Du, L. (2017). Design of CO Concentration Detector Based on Infrared Absorption Method. *Chemical Engineering Transactions*, *62*, 733-738.
- Turner, M. C., Krewski, D., Pope III, C. A., Chen, Y., Gapstur, S. M., & Thun, M. J. (2011). Long-Term Ambient Fine Particulate Matter Air Pollution and Lung Cancer in a Large Cohort of Never-Smokers. *American Journal of Respiratory and Critical Care Medicine*, *184*(12), 1374-1381.
- Wallwork, R. S., Colicino, E., Zhong, J., Kloog, I., Coull, B. A., Vokonas, P., ... & Baccarelli, A. A. (2017). Ambient Fine Particulate Matter, Outdoor Temperature, and Risk of Metabolic Syndrome. *American Journal of Epidemiology*, *185*(1), 30-39.
- Wang, Y., Li, J., Jing, H., Zhang, Q., Jiang, J., & Biswas, P. (2015). Laboratory Evaluation and Calibration of Three Low-Cost Particle Sensors for Particulate Matter Measurement. *Aerosol Science and Technology*, *49*(11), 1063-1077.



THE EFFECTIVENESS OF SCIENTIFIC APPROACH USING ENCYCLOPEDIA AS LEARNING MATERIALS IN IMPROVING STUDENTS' SCIENCE PROCESS SKILLS IN SCIENCE

D. Hernawati*^{1,2}, M. Amin³, M. H. Irawati⁴, S. E. Indriwati⁵, N. Omar⁶

¹Postgraduate Doctoral Student of Biology Study Program, Postgraduate Program,
Universitas Negeri Malang, Indonesia

²Study Program of Biology Education, FKIP, Universitas Siliwangi, Tasikmalaya, Indonesia

³Department of Biology, Faculty of Mathematics and Natural Sciences,
Universitas Negeri Malang, Indonesia

⁴Faculty of Modern Languages and Communication, Universiti Putra Malaysia, Malaysia

DOI: 10.15294/jpii.v7i3.14459

Accepted: May 23rd, 2018. Approved: August 31st, 2018. Published: September 20th, 2018

ABSTRACT

A scientific approach for biology students in the Vertebrate course is needed in order to improve the skills and enrich the experience for new spirit of learning. The research was a quantitative research aiming to explain the influence of the encyclopedia as learning materials used in the scientific approach to improving the students' science process skills. Meanwhile, to reveal the influence of each indicator in each predictor, a qualitative descriptive analysis was employed. The encyclopedia was found to be able to provide visualization to represent an explanation. The respondents in this study were biology students who attended the Vertebrate course. Thirty respondents were selected through a cluster random sampling technique. A test of science process skills was the instrument of this research. Furthermore, the ANOVA was utilized in testing the hypothesis. The analysis results showed that there was a different effect of the learning approach on the basic science process skills. Moreover, there was also a significant influence of the scientific approach to basic science processing skills at a significance level of 0.001 (on corrected model) with F value equal to 7.411. Meanwhile, the significance level for basic science process skills was 0.024 with the p-value <0.05 and F value of 5.357. For the integrated science, there was a significant effect of the learning approach to the integrated science process skills at the significance level of 0.000 with the F value of 12.537. The significance value for the integrated science process skills was 0.044 with p-value <0.05 and F value of 4.224.

© 2018 Science Education Study Program FMIPA UNNES Semarang

Keywords: encyclopedia, scientific approach, science process skills

INTRODUCTION

Improvement of the quality of education is a continuous process from school to college. One of the ways is to train students' skills, and the potentially empowered skill is the science process skills. Science process skills (SPS) define as the development of insight into intellectual, so-

cial and physical skills derived from the basic abilities found in students (Ostlund, 1992; Ozgelen, 2012). The science process skills are necessary for discovery, inquiry and thinking process which help students be lifelong learners (Farsakoglu, 2012; Cigrik & Ozkan, 2015). The sciences process skills (SPS) are divided into two; the basic and integrated SPS. The observation, measurement, classification, conclusion, prediction, and communication belonged to the basic SPS.

*Correspondence Address

E-mail: hernawatibiologi@unsil.ac.id

Meanwhile, the integrated science process is a combination of two or more basic science processes (Kemendikbud, 2011; Nworgu & Otum, 2013). Integrated science process skills include some variables such as controlling, operational definition, hypothesis formulation, data interpretation, and experimentation (Chabalengula, & Mumba, 2010; Lancour, 2006; Padilla, 1990). The improvement of various skills can be done in many ways, by applying various learning approaches, for instance. The scientific approach was chosen in this study since it has been proven to be able to achieve a better learning outcome. A study by Dyer et al. (2011) discovered a concept known as the five discovery skills based on creative intelligence, an intelligence that is beyond the cognitive ability and involves two sides of the brain to create new ideas using 5 skills: associating, questioning, observing, experimenting, and networking (Dyer et al., 2009).

A scientific approach is also called a scientific-based approach. The process aims to acquire systematic scientific knowledge. The scientific approach roots in a scientific method, a concept that emphasizes science more as a verb rather than a noun. The scientific method is a procedure or process that gives priority to more active and participatory methods (Simonneaux, 2014; Baars, 2011; Reid, 2008). This kind of learning strategy can support students to develop hands-on and minds-on (Duda, 2010) as well as their basic ability such as communication skill, interpersonal relation, critical thinking, and problem-solving skill (Lazanyi, 2012). This is strengthened by Kumar (2013) and Prain (2012) who stated that to be able to live in a good competition in the 21st century, young generations must at least own these abilities; communication skill, interpersonal relation, critical and rational thinking, problem-solving, risk-taking, cooperating skill, innovative skill, leadership, and technology. To support the development of hands-on and mind-on students, the use of encyclopedia as teaching materials during has been considered important. An encyclopedia gives a better explanation (Yu & Lam, 2008) and it helps explaining everything as a phenomenon (Mills et al., 2010). An encyclopedia is equipped with scientific information and supported by original photographs. Komalasari (2011) argued that an image or photograph can provide a real picture to show the real object, give livelier learning atmosphere and it is more accurate than words, so as to stimulate the thinking ability of learners.

Abruscato (1995) pointed out a reason why some students were less successful in becoming active and independent students since they were less aware of their basic process skills. Kruea-In Buaraphan (2014) suggested that students' science process skills could be nurtured through proper instruction. Hodosyova et al. (2015) explored the relationship between basic science process skills and learning outcomes. They found that having sufficient understanding and science process skills are considered an important aspect in learning science. Some researches have shown how important science process skills is to be owned by students; however, it should not be forgotten that the integrated science process skills will not be proper if the basic science process skills required by students are not trained from the beginning. Therefore, the basic science process skills must be owned by students before they develop other skills. Fortunately, all these skills can be learned and obtained at school. To support science learning, students should not only learn facts, concepts, laws, and theories in science, but they should also learn the process of how products of science are created. Students should not only learn the products but the process, attitudes, and technology in order to truly understand science as a holistic (Mariana & Praginda, 2009).

There has been no published research on the influence of the encyclopedia-based scientific approach to the students' science process skills. Thus, this study aimed to determine how strong the influence of the scientific approach to science process skills. Furthermore, it was expected that the research results could provide knowledge in the effort to improve the quality of education and the mastery of skills, as well as to enrich the students' experience and grow their passion in learning Biology. The main purpose of this study was to describe the effectiveness of encyclopedia-based scientific approaches to the students' science process skills.

METHODS

This research was carried out to determine the influence of encyclopedia-based scientific approach on the students' science process skills. Meanwhile, to observe the influence of each indicator from each predictor, a qualitative descriptive analysis was used. The researchers had performed this study for 1 semester. The sample in this study were pre-service teachers in biology program amounted to 105 students divided into

five classes. The respondents were 30 students selected through the cluster random sampling technique. The design used quasi-experimental, control group, post-test only design (Creswell, 2012).

The research instruments were tests on basic and integrated science process skills consisting of 20 validated items. The given test was in the form of an essay based on indicators presented by Chabalengula & Mumba (2010), Lancour (2006), and Padilla (1990) as mentioned above. There were two questions for each skill.

Prior to the test, a trial test was done to 32 respondents who were not the research sample. This trial aimed at determining the validity and reliability of the items. The reliability test using

Cronbach's Alpha showed a result of 0.847 for the basic science process skills and 0.876 for the integrated science process skills.

The data were statistically tested using the ANOVA with a significance level of 5% ($p < 0.5$) (Kozub, 2010; Gamst, et al, 2008). The data obtained were first tested on the prerequisite normality and homogeneity test. All data analysis was performed using statistical package for the social sciences version 23.0 for windows.

RESULTS AND DISCUSSION

The results of data analysis to determine the influence of scientific approach to science process skills of biology students are presented in Table 1.

Table 1. Summary of Scientific Approach Analysis to Basic Student Science Process Skills

Source	Type III Sum of Squares	df	Mean Square	F	Sig.
Corrected Model	122.510 ^a	2	61.255	7.411	.001
Intercept	1630.843	1	1630.843	197.312	.000
Group	100.876	1	100.876	12.205	.001
Pretest_kps_basic	44.281	1	44.281	5.357	.024
Error	553.776	67	8.265		
Total	24082.000	70			
Corrected Total	676.286	69			

Based on the results of covariate analysis, it explained that there was a different effect of learning approach on the basic science process skills by eliminating the pre-test of basic SPS as a covariate at the significance level of 0.001 with a value far from 0.05. Simultaneously, there was a significant influence of the scientific approach to the basic science process skills at the significance

level of 0.001 (on the corrected model) with the F value of 7,411. Meanwhile, the significance value for the basic science process skills was 0.024 with p-value < 0.05 and F value of 5.357.

The next analysis was to test the influence of the scientific approach to the integrated science process skills among biology students. The analysis results are presented in Table 2.

Table 2. The Effect of Scientific Approach on Integrated Student Science Process Skills

Source	Type III Sum of Squares	df	Mean Square	F	Sig.
Corrected Model	118.350 ^a	2	59.175	12.537	.000
Intercept	1269.431	1	1269.431	268.951	.000
Group	64.309	1	64.309	13.625	.000
pretest_kps_integrated	19.935	1	19.935	4.224	.044
Error	316.236	67	4.720		
Total	9877.000	70			
Corrected Total	434.586	69			

The significance value of the corrected model shown in Table 2 signaled that there was a significant effect of learning approach on integrated science process skills with the significance level of 0.000 with the F value of 12.537. Meanwhile, the significance value for integrated science process skills was 0.044 with the p-value <0.05 and F value of 4.224. Moreover, the scientific ap-

proach had a significant effect on the integrated SPS with pre-test as the covariate at significance level of 0.05. The obtained value of significance was 0.000.

Results of analysis of student activity based on the results of observation on the learning process with the scientific approach are presented in Table 3.

Table 3. The Analysis of Student Activity

Activities	Score (%)							Means
	1	2	3	4	5	6	7	
Observing	60	60	65	65	77	88	88	71.86
Questioning	80	66	78	78	77	88	88	79.29
Experimenting	83	83	83	88	88	88	88	85.86
Associating	66	66	83	83	66	83	83	75.71
Communicating	66	67	67	83	83	83	83	76.00

A learning process using scientific approach gave relatively good results. The average score was lower than 80, which indicated that some activities such as the observing, reasoning, and communicating need detailed emphasis during the learning process. The learning habit using the scientific approach could improve the students' ability both cooperatively and collaboratively. Therefore, the exploration through learning activities in observation, making inquiries related to observations, conducting experiments, reasoning and communicating results through various interpretations needed improvement (Hernawati et al., 2018). The accumulation of all these stages would improve the intellectual ability, especially in higher-order thinking skills.

Based on the behavioral theory (Schunk, 2012), observation and learning behavior could give impacts to the learning implementation. Several things suggested in behavioral theory include the emphasis on stimulus presentation and strengthening of responses (Thorndike's learning theory), habituation (Pavlov's theory), strengthening (Skinner's theory) need to be the attention for all activities. Based on facts, the concept of meaningful learning as explained in Ausubel's theory is still needed to strengthen through various intellectual skills abilities.

There were seven reports of experimental activities undertaken by students during the learning process using the encyclopedia as the learning materials. The results of the analysis are presented in Figure 1.

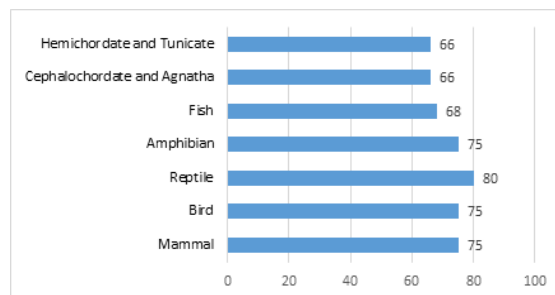


Figure 1. The Analysis of Students' Outcomes based on Experimental Activity

There were seven subjects that the students learned during the research explicitly hemichordate and tunicate, cephalochordate and agnatha, fish, amphibians, reptiles, birds, and mammals. The implementation of learning in the experimental class was carried out based on the steps of the scientific approach, which referred to the decree of Ministry of Education and Culture (Permendikbud) No. 103 Year 2014 by including several items as suggested by Dyer et al, (2009) such as observing, questioning, experimenting, associating, and communicating. In the last five years, conventional classes applied to conventional laboratory work.

The results indicated that active learning involving students in science process skill is needed during the learning process. This kind of activity allows students to improve their critical thinking ability in order to reach their academic target (Tutiaux-Guillon, 2008). Science process

skill was developed through innovative learning and collaborative group study. Chan et al. (2016) stated that any learning activity involving the variety of group discussions would improve students' interpersonal skill. Innovative learning often requires students to develop more autonomy and responsibility as well as self-awareness due to the student-centered activities (Bédard & Béchar, 2009). Some researches stated that science process skills could develop cognitive skills and support students' thinking, intellectual, examining, and problem-solving skills (Ozgelen, 2012). Thereover, there is a strong correlation between the students' science skills with the properties of science process skills. Previous studies have shown that science process skills are the important part that influences students' achievement (Baser & Durmus, 2010).

The observing skill is the most important thing for developing the other process skills (Abruscato, 1995; Carin, et al., 2005). Performing a measurement requires knowledge to use the measuring equipment properly (Abruscato, 1995; Carin, et al., 2005). Classification is a process skill for selecting various objects based on certain traits (Abruscato, 1995; Carin, et al., 2005). Furthermore, the inferencing skill refers to the development of possible conclusions. Predicting skill relates to making specific statements about everything based on certain patterns or trends. Valid prediction requires precise and correct determination (Abruscato, 1995; Carin, et al., 2005). Meanwhile, the communication skill is an effort in conveying relevant ideas. All of these basic science process skills are required as a bridge to improve the integrated SPS. This explanation is related to the study of Prihatnawati et al (2017) that science process skill could be improved with the module as the teaching materials.

The integrated SPS is essentially the skills needed to conduct research (Abruscato, 1995; Carin et al., 2005). Similar skill is required in defining operational variables that covers certain considerable limits depending on the area of science. Operational definitions are varied depending on the subject, for example, recognizing the attributes of independent variables, the scope limitation of the dependent variable (Abruscato, 1995). Data interpretation involved other science process skills, such as tabulating the data, drawing conclusions, and analyzing the data either quantitatively or qualitatively as a basis for testing the hypotheses. Experimenting defines as a skill to conduct testing on ideas originating from facts, concepts, and principles of science (Abruscato, 1995).

The process skills are the assimilation of various intellectual skills that can be applied to the learning process (Feyzioglu, 2009; Ozturk et al., 2010). Based on the Piaget's cognitive development stage, basic skills can be nurtured in the early stages of cognitive development, while the integrated skills can be introduced later in the formal operational development stage (King, 2011). Thus, the existence of the scientific approach with five aspects including observing, questioning, experimenting, associating, and communicating, supports the improvement of students' science process skills. Triyuni (2016) stated that scientific approach provides a positive and good learning environment that is conducive to improve the students' skills.

CONCLUSION

Based on the above discussion, the scientific approach applied in the learning process has proven effective in improving the basic SPS and integrated SPS among biology students. The statistical analysis informed that scientific approach significantly influenced the basic SPS and integrated SPS of biology students. In sum, the scientific approach had the right learning syntax to enhance and develop the students' academic abilities and gave them various skills.

ACKNOWLEDGEMENTS

We would like to thank the Doctoral Dissertation Research Grant from the Directorate of Research and Community Service, Directorate General of Research and Strengthening of Development, Ministry of Research, Technology and Higher Education of Indonesia for the funding of this research, As per decision no. 0045 / E3 / LL / 2018 on acceptance of research funds and community service in higher education by 2018.

REFERENCES

- Abruscato, J. (1995). *Teaching children science: A discovery approach*. Boston: Allyn & Bacon.
- Baars, T. (2011). Experiential Science; towards an Integration of Implicit and Reflected Practitioner-Expert Knowledge in the Scientific Development of Organic Farming. *Journal of agricultural and environmental ethics*, 24(6), 601-628.
- Baser, M., & Durmus, S. (2010). Mustafa. The Effectiveness of Computer Supported Versus Real Laboratory Inquiry Learning Environments on the Understanding of Direct Current Electricity among Pre-Service Elementary School Teachers. *Eurasia Journal of Mathematics, Science*

- & *Technology Education*, 6(1), 47–61.
- Bédard, D., Lison, C., Dalle, D., Côté, D., & Boutin, N. (2012). Problem-based and Project-based Learning in Engineering and Medicine: Determinants of Students' Engagement and Persistence. *Interdisciplinary Journal of Problem-Based Learning*, 6(2), 7-30.
- Carin, A. A., Bass, J. E., & Contant, T. L. (2005). *Methods for Teaching Science as Inquiry*. Upper Saddle River, NJ: Pearson Education, Inc.
- Chabalengula, V. M., Mumba, F., & Mbewe, S. (2012). How Pre-Service Teachers' Understand and Perform Science Process Skills. *Eurasia Journal of Mathematics, Science & Technology Education*, 8(3), 167-176.
- Chan, Y. F., Sidhu, G. K., Suthagar, N., Lee, L. F., & Yap, B. W. (2016). Relationship of Inquiry-Based Instruction on Active Learning in Higher Education. *Pertanika Journal of Social Sciences & Humanities*, 24, 55-71.
- Cigrik, E., & Ozkan, M. (2015). The Investigation of the Effect of Visiting Science Center on Scientific Process Skills. *Procedia-Social and Behavioral Sciences*, 197, 1312-1316.
- Creswell, J.W. (2012). *Educational Research: Planning, Conducting, and Evaluating Quantitative and Qualitative Research*. Boston: Pearson
- Duda, H. J. (2010). Pembelajaran Berbasis Praktikum dan Asesmennya pada Konsep Sistem Ekskresi untuk Meningkatkan Kemampuan Berpikir Kritis Siswa Kelas XI. *Jurnal VOX Edukasi*, 1(2), 29-39.
- Dyer, J. H., Gregersen, H. B., & Christensen, C. M. (2009). Five "Discovery Skills" Separate True Innovators from the Rest of Us. *Harvard Business Review*.
- Dyer, J., Gregersen, H., & Christensen, C. M. (2011). *The Innovator's DNA: Mastering the Five Skills of Disruptive Innovators*. Harvard Business Press.
- Farsakoglu, O.F., Sahin, C., Karsli, F., Akpinar, M., & Ultay, N. (2008). A Study on Awareness Levels of Prospective Science Teachers on Science Process Skills in Science Education. *World Applied Sciences Journal*, 4, 174-182.
- Feyzýođlu, B. (2009). An Investigation of the Relationship between Science Process Skills with Efficient Laboratory Use and Science Achievement in Chemistry Education. *Journal of Turkish Science Education*, 6(3), 114-132.
- Gamst, G., Meyers, L. S., & Guarino, A. J. (2008). *Analysis of Variance Designs: A Conceptual and Computational Approach with SPSS and SAS*. Cambridge University Press.
- Hernawati, D., Amin, M., Irawati, M., Indriwati, S., & Aziz, M. (2018). Integration of Project Activity to Enhance the Scientific Process Skill and Self-Efficacy in Zoology of Vertebrate Teaching and Learning. *EURASIA Journal of Mathematics, Science and Technology Education*, 14(6), 2475-2485.
- Hodosyová, M., Útla, J., Vnuková, P., & Lapitková, V. (2015). The Development of Science Process Skills in Physics Education. *Procedia-Social and Behavioral Sciences*, 186, 982-989.
- Kemendikbud. (2011). Pedoman Pembuatan Alat Peraga Biologi Sederhana untuk SMA [Guidelines for the Manufacture of Biology Simple Props for Senior High Schools]. Jakarta: Direktorat Pembinaan SMA Dirjen Pendidikan Menengah Kemendikbud.
- King K.P. (2011). Working with Young People: Intellectual Development over Time. Retrieved on 2012 February 1 from sites.roosevelt.edu/kking/files/2011/11/Development-and-STEM-Education.pdf
- Kozub, R. M. (2010). An ANOVA Analysis of the Relationships Between Business Student's Learning Styles and Effectiveness of Web Based Instruction. *American Journal of Business Education*, 3, 18-30.
- Komalasari. (2011). *Pembelajaran Kontekstual: Konsep dan Aplikasi*. Bandung: Refika Aditama.
- Kumar, A. (2013). Twenty First Century Educational Skills and Restructuring of Education System: A View to Ponder Upon. *International Journal of Advancement in Education and Social Sciences*, 1(1), 1-4.
- Kruca-In, N., & Buaraphan, K. (2014). Enhancing Lower Secondary School Science Teachers' Science Process Skill and Laboratory Lesson Preparation Through a Social Constructivist-Based Professional Development Workshop. *The International Journal of Science, Mathematics, and Technology Learning*, 20, 43-56.
- Lancour, K. L. (2006). *Process Skills for Life Science: Training Guide*.
- Lazanyi, K. (2012). Study for Nothing? Literature Overview of Labour Market Opportunities of Individuals with Tertiary Education. In *Proc. of FIKUSZ'12 Symposium for Young Researchers* (pp. 37-45).
- Mariana, I. M. A., Praginda, W., & Si, M. (2009). Hakikat IPA dan Pendidikan IPA. *Bandung: PPPPTK IPA*.
- McGregor, D. (2007). *Developing Thinking; Developing Learning*. McGraw-Hill Education (UK).
- Mills, A. J., Durepos, G., & Wiebe, E. (Eds.). (2010). *Encyclopedia of Case Study Research: L-Z; index* (Vol. 1). Sage.
- Nworgu, L. N., & Otum, V. V. (2013). Effect of Guided Inquiry With Analogy Instructional Strategy On Students Acquisition Of Science Process Skills. *Journal Education and Practice*, 4(27), 35-40.
- Ostlund, K. L. (1992). *Science Process Skills: Assessing Hands-On Student Performance*. New York: Addison-Wesley.
- Özgelen, S. (2012). Students' Science Process Skills within a Cognitive Domain Framework. *Eurasia Journal of Mathematics, Science & Technology Education*, 8(4), 283-292.
- Öztürk, N., Tezel, Ö., & Acat, M. B. (2010). Science Process Skills Levels of Primary School Seventh Grade Students in Science and Technology

- Lesson. *Journal of Turkish Science Education (TUSED)*, 7(3), 15-28.
- Padilla, M. J. (1990). The Science Process Skills. *Research Matters-to the science Teacher*, 9004.
- Prain, V. (2012). Acting on sustainability. *Research in Science Education*, 42(1), 149-154.
- Prihatnawati, Y., Amin, M., Al Muhdar, M.H.I. (2017). The Effect of Module Implementation with STAD Cooperative Learning toward Process Skills in Science and Cognitive Achievement of 8th Grade Students. International Conference on Learning Innovation (ICLI 2017). *Advances in Social Science, Education and Humanities Research*, volume 164, 111-115.
- Reid, N. (2008). A Scientific Approach to the Teaching of Chemistry. What Do We Know about How Students Learn in the Sciences, and How Can We Make Our Teaching Match This to Maximise Performance?. *Chemistry Education Research and Practice*, 9(1), 51-59.
- Schunk, DH. (2012). *Learning Theories an Educational Perspective*. Yogyakarta: Pustaka Pelajar.
- Simonneaux, L. (2014). Questions Socialement Vives and Socio-Scientific Issues: New Trends of Research to Meet the Training Needs of Postmodern Society. In *Topics and Trends in Current Science Education* (pp. 37-54). Springer, Dordrecht.
- Triyuni, T. (2016). The Influence of Science Learning Set Using Scientific Approach and Problem Solving Model on Learning Outcomes of Junior High School Students in the Subject of Heat and Temperature. *Jurnal Pendidikan IPA Indonesia*, 5(2), 177-185.
- Tutiaux-Guillon, N. (2008): *Interpréter la stabilité d'une discipline scolaire : l'histoire-géographie dans le secondaire français*. In: F. Audigier & N. Tutiaux-Guillon: *Compétences et contenus*, pp 117-146, De Boeck Université, Bruxelles.
- Yu, X., & Lam, W. (2008). An Integrated Probabilistic and Logic Approach to Encyclopedia Relation Extraction with Multiple Features. In *Proceedings of the 22nd International Conference on Computational Linguistics-Volume 1* (pp. 1065-1072). Association for Computational Linguistics.

**THE PROFILE OF XI GRADE STUDENTS' SCIENTIFIC THINKING ABILITIES ON SCIENTIFIC APPROACH IMPLEMENTATION****Suciati*¹, M. N. Ali², C. D. Imaningtyas³, A. F. Anggraini⁴, Z. Dermawan⁵**^{1,3,4,5}Master Program of Science Education Department, Sebelas Maret University²Universiti Sains Malaysia

DOI: 10.15294/jpii.v7i3.15382

Accepted: May 30th, 2018. Approved: August 31st, 2018. Published: September 20th, 2018**ABSTRACT**

This study aimed at analyzing XI grade students' scientific thinking abilities on the implementation of the scientific approach. 82 students of XI grade science class at three state senior high schools in Surakarta involved in this study. The students' scientific thinking abilities illustrated as the students' competence in seven aspects: the purpose of science; science question, science information, science interpretation, science concept, science assumption, science implication (Paul & Elder, 2003). The data on students' scientific thinking abilities were collected using essay test on worksheet and interview methods. The instrument had been validated by expert judgement and students as a user. The scores were used to represent the students' scientific thinking abilities in three categories (low, middle, high). The results of the study showed that students' competence in seven aspects of scientific thinking abilities: purpose of science (62,00%); science question (36,6%), science information (39,66%), science interpretation (41,00%), science concept (43,33), science assumption (38,33%), science implication (21,33%). Therefore, it concluded that the XI grade students' scientific thinking abilities on the implementation of scientific approach was at the low category. It was suggested that the learning model based scientific approach be conducted for the students' scientific thinking abilities improvement.

© 2018 Science Education Study Program FMIPA UNNES Semarang

Keywords: scientific thinking abilities, scientific approach, 2013 curriculum

INTRODUCTION

There are 4 skills demanded for 21st century generation called the 4C (creativity and innovation, critical thinking and problem solving, communication, and collaboration) (Osman et al., 2013; Manzon, 2017; Howard et al., 2015). Hence, the 21st century education is required to empower the students' scientific abilities (Osborne, 2013). Scientific thinking is a form of knowledge seeking that involves the process of thinking to increase knowledge or intellectual; thereby, scientific thinking ability is not what already in a person's mind but the process of thinking that

must be habituated to encourage the increase of knowledge (Kuhn, 2010; Paul & Elder, 2003). Scientific thinking ability is the result of the scientific discovery method applied in problem-solving by proving a theory (Zimmerman, 2007). Scientific thinking is obtained through inductive and deductive reasoning to find answers through explorations of factual scientific investigation, problem formulation, hypothesis, design, evaluation of evidence, hypothesis testing with experiment, and conclusions (Thitima & Sumalee, et al., 2012). Scientific thinking ability can be considered as part of critical thinking through claims and arguments about persons' behavior from a scientific view. Thus, scientific thinking is a form of logical reasoning in a scientific paradigm (Kagee et al., 2010; Stevens & Witkow, 2014).

*Correspondence Address

E-mail: suciati.sударisman@yahoo.com

According to Paul & Elder (2003) there are 8 characteristics of scientific thinking: (1) the purpose of scientific thinking. Scientific reasons always have a purpose, therefore the delivery of scientific objectives to be achieved must be realistic and clear; (2) the emergence of scientific questions is usually related to the issues discussed. Generally, the questions are sub-questions to clarify the purpose and scope of the problem; (3) scientific assumptions obtained by clearly identifying the problem considering how the assumption is built on a particular point of view; (4) scientific point of view. Assumptions are built on views, therefore, it needs to be identified initially to ensure the scientific view. Once the scientific points are found, further identification of the strengths and weaknesses is required; (5) scientific information. Scientific thinking is always based on data, information, and scientific evidence. Not all claims are used, but limited only for the clear, accurate and relevant data to the question of the problem; (6) the scientific concepts. Scientific thinking is built on scientific concepts and theories. The concepts or theories used must be accurately and carefully identified, since only scientific and clear concepts and theories are used; (7) scientific interpretations and inferences. Scientific thinking will lead to scientific conclusions referring to the inferences or interpretation that gives meaning to scientific data. Conclusions are drawn only on the basis of the obtained data, thus, conclusions need to be checked for consistency with the existing data and identify which assumptions underlying the conclusions; and (8) scientific implications and consequences. Scientific thinking always has both negative and positive implications and consequences, both of which can be found by tracing them through data and thought. Referring to the characteristics of scientific thinking, then scientific thinking can be trained. This is relevant to Kuhn (2002) that training scientific thinking can be done through 4 phases of activities including: (1) investigation; (2) analysis; (3) inference; and (4) argument. Moreover, Koerber, et al. (2015) argued that scientific thinking can be developed through activities such as hypothesis testing, systematic experiments, data interpretations related to hypotheses, and a more general understanding of the nature of science. In nurturing scientific thinking ability, it is necessary to change the paradigm of learning from the teacher center to the student center, from learning that emphasizes the content to the process, the textual approach to the contextual and the scientific approach, the transfer of knowledge toward problem solving. Efforts to optimize the implementation 2013 curriculum

in stages show that the Indonesia Government commits to responding the challenge of globalization era in order to meet the demands of 21st-century skills of human resources. One of the important changes as contained in the science curriculum (Indonesia Minister of Culture and Education Regulation No.103 of 2014) is a shift from a textual approach to a scientific approach.

A scientific approach is a learning approach adopted from scientist steps in building knowledge through the scientific method by using inductive reasoning rather than deductive reasoning. Inductive reasoning starts by looking at a specific phenomenon or situation to then draw the overall conclusion. Inductive reasoning puts specific evidence into a wider relationship. Scientific methods generally originate from a unique phenomenon with specific and detailed studies to then be drawn conclusions in general through investigative activities. To be scientific, the method of inquiry should be based on the evidence, observable, empirical, and measurable objects with specific principles of reasoning. The scientific approach is the organization of learning experiences in a logical sequence comprising observing, questioning, gathering information, reasoning, and communicating. Learning with a scientific approach is a learning process designed in such a way that learners actively construct concepts, laws or principles through a series of data collection activities such as observation, identifying problems, formulating hypotheses, testing hypotheses through investigation (experimenting), processing data or information, gathering and analyzing and by various techniques, drawing conclusions and communicating concepts, laws or principles found (Hosnan, 2014; Daryanto, 2014).

The characteristics of a scientific approach are: (1) The substance or subject matter is based on facts or phenomena which can be explained by certain logic or reasoning, not just imagination, story, reading, alone; (2) Teacher explanation, student response, and interaction between teacher and student are free from subjective thinking or reasoning that deviates from the logical thinking flow; (3) Encourage and inspire students to think critically, analytically and appropriately in identifying, understanding, solving problems and applying substance or subject matter; (4) Encourage and inspire learners to be able to think hypothetically in view of differences, similarities and links to one another from the substance or learning material; (5) Encourage and inspire learners to be able to understand, apply and develop rational and objective thinking patterns in

response to substance or learning materials; (6) Based on empirical concepts, theories and empirical facts that can be accounted for; (7) Learning objectives are formulated in a simple, clear, and interesting presentation system. Referring to the characteristics of the scientific approach, it can be argued that the scientific approach not only views learning outcomes as the final estuary, but the learning process is considered very important. Since the scientific approach emphasizes on the process skills, so it is believed to be a golden bridge for the development of attitudes, skills, and knowledge, especially in the empowerment of students' scientific thinking. Departing from the description above, this research was conducted to analyze the XI grade students' scientific thinking abilities with regard to the implementation of the scientific approach.

METHODS

The study involved 82 students of XI grade science class at three state senior high schools in Surakarta. The students' scientific thinking abilities illustrated as their competence in seven aspects: the purpose of science; science question, science information, science interpretation, science concept, science assumption, science implication (Paul & Elder, 2003; Dejonckheere, 2009; Dilekli & Tezci, 2016). The data on students' scientific thinking abilities were collected using essay test on the worksheet by formulating a hypothesis, determining variables and analyzing the results of the investigation (Ghojazadeh et al., (2014) and interview methods. Interviews with students focused on students' 'difficulties in filling out worksheets related to students' scientific thinking skills (Kong, 2015). The instrument had been validated by expert judgment and students as a user. The scores were used to represent students' scientific thinking abilities in two categories (low and high category); $\leq 50\%$ for the low category and $> 50\%$ for the high category.

RESULTS AND DISCUSSION

The students' competence in seven aspects of scientific thinking abilities: purpose of science (62,00%); science question (36,66%), science information (39,66%), science interpretation (41,00%), science concept (43,33%), science assumption (38,33%), science implication (21,33%) is shown in Figure 1. The percentage of each aspect was obtained from the score of the students, which were divided by the maximum score that students can get from certain aspects and then

multiplied by 100%. Among those abilities, the students demonstrated moderate ability in the purpose of science, whereas in the other six components, students had the low ability of scientific thinking.

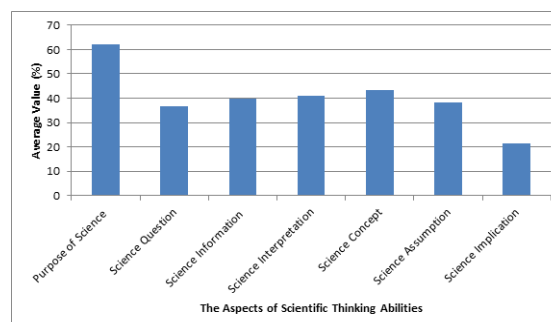


Figure 1. The Students' Competence in Seven Aspects of Scientific Thinking Abilities

The data analysis showed that the students' scientific thinking ability profile could be categorized as low. Meanwhile, from the observation data showed that teachers have not implemented a scientific approach to learning optimally. The teachers remained dominating the learning process and tended to be teacher centered. This was supported by the results of interviews with teachers that 75% of them declared a lack of understanding of scientific approaches, especially with regard to its implementation. This condition was also supported by the research done by Restami et al., (2013) which showed the average score of teachers' ability to implement a scientific approach was between 45% -50%. The teachers explained that they required more training, especially in terms of scientific approach concept and its practice in teaching and learning. Thus, it argued that the lack of teachers' competence in implementing of the scientific approach would results in a weak students' scientific thinking ability empowerment, since learning is a system that includes: input, process, output. A learning environment that merely involving the transfer of knowledge from the teacher to the students would not provide meaningful experience to students; thus, it encourages students toward rote learning.

Meanwhile, according to Ausubel, learning through experiences with contextual and meaningful activities, could make learning become engaging and having longer retention (Ratna, 2011; Jensen et al., 2014). The process of learning through observation has a high significance (Ary et al., 2018; Jewett & Kuhn 2016). The data observation showed that the activity of "asking" was generally initiated by the teacher rather than by the student. Thus students' scientific

thinking ability was not developed. This is relevant to Sa'ud (2011) opinion that the activity of asking questions (asking) can be viewed as a reflection of the curiosity of an individual, while answering questions is reflecting of students' thinking ability. If the activities to tackle the scientific thinking (investigation, analysis, inference, arguments) through a series of scientific process stages such as hypothesis testing, systematic experiments, data interpretation related to hypothesis, and a more general understanding of the nature of science are not properly planned and extrinsically implemented, then do not expect students' scientific thinking ability to thrive (Kuhn, 2002; Koerber et al., 2015; Underwood, 2015). This is supported by Osman et al. (2013) and Collin (2014) opinion that inquiry learning can train students to improve their ability to explore, so they can find their own knowledge. By not accustoming the students to learning through inquiry, the students' scientific thinking skills are low. The followings are examples of the students' work that evidenced the students' low scientific thinking skills.

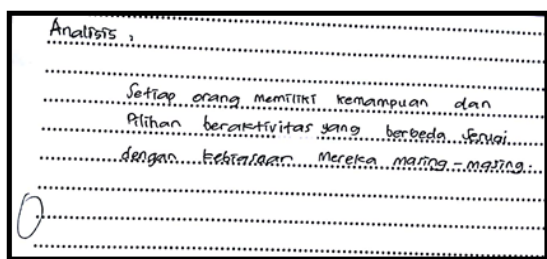


Figure 2. The Example of Student Work on Scientific Purpose Aspect

The data in Figure 2 shows that the students were careless in analyzing the presented images. It should be based on the presentation of observed images that could guide the students to understand the purpose of the specified activity. This supported the fact that the students' scientific purpose was low.

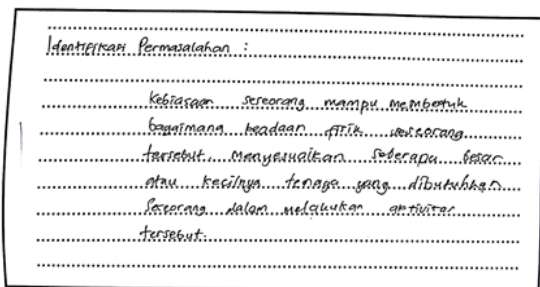


Figure 3. Examples of Student Work on Aspects in Formulating Problems

The data in Figure 3 informs that the students were inattentive in identifying problems based on the image presentation. The problems raised by the students have not used the question sentence, but in the form of narrative. This showed that students were less able to make scientific questions.

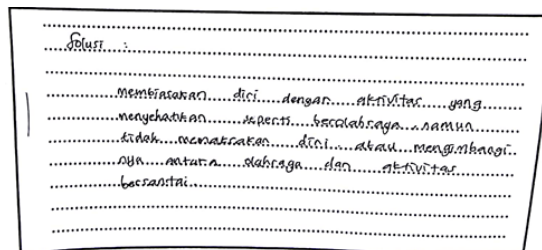


Figure 4. The Example of Student Work on Aspects of Developing Hypotheses

The data in Figure 4 describes the solutions proposed by the students did not answer the problems they have formulated previously. Ideally, the hypothesis made must be relevant to the formulation of the proposed problems.

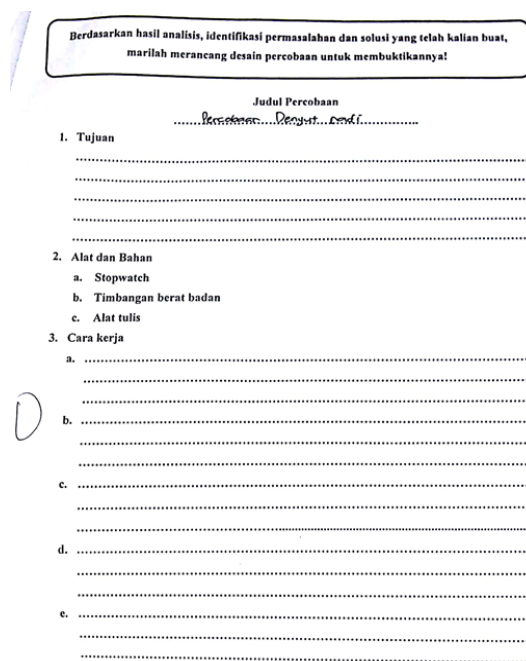


Figure 5. Example of Student Worksheet in Designing Experiments

The data in Figure 5 indicates that the students have not been able to make experimental designs well even though they have been given clue. The students worked on an empty worksheet. This pointed out that the scientific concept aspect of the students was low.

4. Perhitungan Denyut Nadi Antara Orang Beraktifitas Dan Beristirahat

No.	Nama Siswa	Jenis Aktifitas	Denyut Nadi/Menit
	Andron	Lari	105

Figure 6. The Example of Student Work in Data Organizing

The data in Figure 6 informs that the students did not comprehend the command to compare the number of pulses between people who move and rest. As a result, the data were difficult to be analyzed.

B. Kesimpulan percobaan
Berdasarkan aktivitas percobaan maka dapat disimpulkan faktor-faktor yang mempengaruhi denyut nadi adalah

0

.....

.....

.....

.....

Figure 7. The Example of Student Work in Making Conclusions

The data in Figure 7 shows that students could not conclude well. This can be seen from an empty worksheet.

CONCLUSION

Based on the research findings, it concluded that the XI grade students' profiles of scientific thinking abilities on the implementation of scientific approach was at the low category. It suggested that the scientific approach-based learning be conducted to further develop students' scientific thinking abilities.

REFERENCES

- Ary, D., Jacobs, L. C., Irvine, C. K. S., & Walker, D. (2018). *Introduction to Research in Education*. Cengage Learning.
- Collins, R. (2014). Skills for the 21st Century: Teaching Higher-Order Thinking. *Curriculum & Leadership Journal*, 12(14).
- Daryanto, D. (2014). *Pendekatan Pembelajaran Sainifik Kurikulum 2013*. Yogyakarta: Gava Media.
- Dejonckheere, P. J., Van De Keere, K., & Mestdag, N. (2009). Training the Scientific Thinking Circle in Pre-And Primary School Children. *The Journal of Educational Research*, 103(1), 1-16
- Dilekli, Y., & Tezci, E. (2016). The Relationship among Teachers' Classroom Practices for Teaching Thinking Skills, Teachers' Self-Efficacy towards Teaching Thinking Skills and Teachers' Teaching Styles. *Thinking Skills and Creativity*, 21, 144-151.
- Thitima, G., & Sumalee, C. (2012). Scientific Thinking of the Learners Learning with the Knowledge Construction Model Enhancing Scientific Thinking. *Procedia-Social and Behavioral Sciences*, 46, 3771-3775.
- Ghojazadeh, M., Ahmadi, S., Hosseini, M. A., Shahabi, S., Tahamtani, T., Nourbakhsh, F., ... & Khoshbaten, M. (2014). Assessment of Scientific Thinking in Basic Science Questions in the Iranian Fourth National Olympiad for Medical Sciences Students. *J Anal Res Clin Med*, 2(3), 142-151.
- Hosnan, M. (2014). *Pendekatan Sainifik dan Kontekstual dalam Pembelajaran Abad 21: Kunci Sukses Implementasi Kurikulum 2013*. Ghalia Indonesia.
- Howard, L. W., Tang, T. L. P., & Austin, M. J. (2015). Teaching Critical Thinking Skills: Ability, Motivation, Intervention, and the Pygmalion Effect. *Journal of Business Ethics*, 128(1), 133-147.
- Jensen, J. L., McDaniel, M. A., Woodard, S. M., & Kummer, T. A. (2014). Teaching to the Test... or Testing to Teach: Exams Requiring Higher Order Thinking Skills Encourage Greater Conceptual Understanding. *Educational Psychology Review*, 26(2), 307-329.
- Jewett, E., & Kuhn, D. (2016). Social Science as a Tool in Developing Scientific Thinking Skills in Underserved, Low-Achieving Urban Students. *Journal of Experimental Child Psychology*, 143, 154-161.
- Kagee, A., Allie, S., & Lesch, A. (2010). Effect of a Course in Research Methods on Scientific Thinking among Psychology Students. *South African Journal of Psychology*, 40(3), 272-281.
- Koerber, S., Mayer, D., Osterhaus, C., Schwippert, K., & Sodian, B. (2015). The Development of Scientific Thinking in Elementary School: A Comprehensive Inventory. *Child Development*, 86(1), 327-336.
- Kong, S. C. (2015). An Experience of a Three-Year Study on the Development of Critical Thinking Skills in Flipped Secondary Classrooms with Pedagogical and Technological Support. *Computers & Education*, 89, 16-31.
- Kuhn, D. (2002). What is Scientific Thinking and How Does it Develop?. *Blackwell handbook of childhood cognitive development*, 371-393.
- Kuhn, D. (2010). What is Scientific Thinking and How Does it Develop?. *Blackwell handbook of childhood cognitive development*. 2nd Edition. New York: Columbia University.
- Manzon, M. R. P. (2017). Classroom Assessment Technique (Cat) and Its Examples. *International Journal of Research*, 4(17), 4037-4046.
- Osborne, J. (2013). The 21st Century Challenge for Science Education: Assessing Scientific Reasoning. *Thinking Skills and Creativity*, 10, 265-279.
- Osman, K., Hiong, L. C., & Vebrianto, R. (2013). 21st Century Biology: An Interdisciplinary Approach of Biology, Technology, Engineering and Mathematics Education. *Procedia-Social and Behavioral Sciences*, 102, 188-194.
- Paul, R., & Elder, L. (2003). *Miniature Guide for Student and Faculty to Scientific Thinking: The Foundation for a Critical Thinking*. Sonoma University.

- Ratna, W. D. (2011). Teori-Teori Belajar dan Pembelajaran. *Bandung: Erlangga*.
- Sa'ud, U.S. (2011). Inovasi Pendidikan. *Bandung: Alfabeta*.
- Stevens, C., & Witkow, M. R. (2014). Training Scientific Thinking Skills: Evidence from an MCAT2015-Aligned Classroom Module. *Teaching of Psychology, 41*(2), 115-121.
- Restami, M. P., Suma, K., & Pujani, M. (2013). Pengaruh Model Pembelajaran Poe (Predict-Observe-Explain) Terhadap Pemahaman Konsep Fisika dan Sikap Ilmiah Ditinjau Dari Gaya Belajar Siswa. *Jurnal Pendidikan dan Pembelajaran IPA Indonesia, 3*(1).
- Underwood, M. J. (2015). Searching for Commonalities in the Teaching of Critical Thinking Skills, From Masters' to Sixth Form to Primary.
- Zimmerman, C. (2007). The Development of Scientific Thinking Skills in Elementary and Middle School. *Developmental Review, 27*(2), 172-223.