

DEVELOPING INQUIRY-BASED PRACTICE EQUIPMENT OF HEAT CONDUCTIVITY TO FOSTER THE STUDENTS' CRITICAL THINKING ABILITY

Ratna Agustini¹, Agus Suyatna^{*2}

¹ State Junior High school 3 Blambangan Umpu, Way Kanan, Lampung, Indonesia

² Department of Physics Education, Universitas Lampung, Lampung, Indonesia

*Correspondence address: asuyatna@yahoo.com

Accepted: October 7th, 2017. Approved: February 1st, 2018. Published: April 28th, 2018

Abstract: The purpose of this research is to develop inquiry-based practice equipment of heat conductivity to foster the students' critical thinking ability. The research method employed was research and development (R & D). The development model used was ADDIE (Analysis-Design-Development-Implementation-Evaluation) model. Validation of product development was done by science education experts. Field-testing was conducted to the seventh-grade students of State Junior High school 3 (SMP Negeri 3) Blambangan Umpu Way Kanan. The data collection was done through observation, questionnaires, and tests of the effectiveness of fostering students' critical thinking ability. Data analysis was done through paired sample T-Test and independent sample T-Test. The results showed that the inquiry-based practice equipment of heat conductivity was effective in fostering the students' critical thinking ability the value of N-gain 0.70 (high category). The equipment and its guides were considered interesting, practical, and useful by the students. So, it is concluded that the inquiry-based practice equipment of heat conductivity is able to foster the students' critical thinking ability.

© 2018 Physics Education, UIN Raden Intan, Lampung, Indonesia.

Keywords: Critical thinking, inquiry, heat conductivity, practice equipment

INTRODUCTION

Natural Science is a science that studies certain phenomena systematically (Inzanah, Ibrahim, & Widodo, 2014). Science learning is application-oriented to develop learning ability, thinking ability, curiosity, and caring and responsible attitude to the social and natural environment (Nisa', Sudarmin, & Samini, 2015). Natural Science is needed to build students' skills in solving a problem and caring the surrounding environment (Arisman & Permanasari, 2015).

The process of science learning can be felt directly by students in developing their competence to understand the natural surroundings in a scientific way. But today science is only a product, rigid, and legal theory. As a result, the attitude, the process in everyday life and the application are untouched (Inzanah et al., 2014). Natural Science is not enough to be learned only

through explanation and listening, but also by understanding the material and concepts by doing activities to find the concepts (Abdurrahman, Saregar, & Umam, 2018; Anwar, 2017; Dewi, 2016; Saregar, Marlina, & Kholid, 2017).

One of the learning activities in science learning that apply the scientific method in learning is practicum activity (Maulida & Kusumaningtyas, 2017). Running the lab course must be supported by the existence of adequate practicum equipment.

Based on the observation at State Junior High School 3 Blambangan Umpu, Way Kanan, there were still many practicum equipments that was not effectively used, for example, the heat conductivity equipment that can only be used to investigate the metal that transfers heat but cannot use to determine the rate of heat transfer. Consequently, it cannot encourage students' critical thinking

during the practicum. While it is known that the ability to think critically is a competency that must be mastered by students (Latifah, 2015).

Based on preliminary study for the teacher in the analysis phase, the result of the questionnaire for the teachers' need analysis are: a) the presence of equipment for heat transfer material especially conductive heat transfer but rarely used because of difficulties in its application, b) students were less enthusiastic during learning, c) it needs a simple heat conductivity transfer practicum equipment that is easy to use.

The questionnaire results of the students' need analysis were taken from 30 students of seventh of State Junior High School 3 Blambangan Umpu, Way Kanan in the 2016 academic year that have studied the heat transfer. More than 90% of the students need an alternative learning media in the form of equipment that is simple and interesting to study the concept of heat conductive transfer so that the learning process can stimulate the students' critical thinking ability.

In the 21st century, critical thinking learning needs to be prepared so that graduates can compete in filling the job market, so critical thinking becomes one of the skills that need to be developed in the educational process (Lastriningsih, 2017). Critical thinking is the ability and process involved in making a rational decision and is an attitude that is used by someone to judge something (Diana Putri & Djamas, 2017). Skills in analyzing arguments, solving problems, evaluating, and making conclusions are part of critical thinking (Nuriyatin & Hartono, 2016). For this purpose, education tries to help students learn to organize and construct opinions, to formulate problems, to develop hypotheses, and to seek their evidence to foster students' critical thinking skills (Bell, Urhahne, & Schanze, 2013).

To equip the ability to think critically for students, it is necessary to have student-

centered learning. Student-centered learning is inquiry-based learning, in which the students are required to play an active role in learning (Asyhari & Hartati, 2015). Inquiry learning involves students in formulating scientific questions, proposing hypotheses, collecting and analyzing the results of investigations, reasoning on phenomena, and communicating results to teachers and other students (Abdurrahman, 2017). Student-centered learning can be done to stimulate students' critical thinking skills, one of them through practicum activities. In practice, it is necessary to have practicum equipment that can foster the students' learning activities and provide a real experience and interest the students so that learning activities are not boring and all the senses of students can be activated. Based on these conditions, the researcher developed practicum equipment of heat conductivity through inquiry-based worksheet as a guide.

To develop relevant equipment related to heat transfer material, a research was conducted by Rokhimi and Pujayanto on Conductivity Rate Learning Instrument (Rokhimi & Pujayanto, 2015). The differences of this research with previous research are, that the equipment is equipped with inquiry-based student worksheet to foster the students' critical thinking ability. Based on this, then researchers consider this research is important to be done.

METHOD

The method used by researchers was research and development. The development model used was ADDIE model (Analysis -Design - Development - Implementation-Evaluation). This research resulted in the development of practicum equipment in the form of heat conductivity equipment to foster students' critical thinking ability on the concept of heat transfer. The developed heat

conductivity equipment is complemented by inquiry-based student worksheet. The product of the initial development is called prototype 1 and was revised to meet the criteria of the validators.

The first testing done was expert validation. This testing was conducted to validate the feasibility of the product so it can be known whether the developed product was feasible to use. Expert validation was carried out by three experts in the field of science education. The validation tests covered the appropriateness of the product with the learning objectives and the effectiveness of the equipment. A validation test was repeatedly done until the product of development was declared as valid. The one-on-one test was performed by peers as users of the heat conductivity equipment to assess the easiness and usefulness of the tools in assisting the learning process.

The assessment was done by teachers as practitioners who taught in the seventh grade of Junior High School. This process was done to determine the practicability of heat conductivity equipment and to check the error of writing on the student worksheet. Furthermore, a small group testing was also conducted to find out the product's usability in learning. The results obtained from this small group testing were used to adjust the use of the product in the learning. The evaluation results obtained from the testing were used for product revision so that it can be feasible to use.

Product development results that have been feasible were field-tested to 60 students of seventh-grade class VII A and VII B of the State Junior High School 3 Blambangan Umpu Way kanan. Data collecting techniques were observation, questionnaires, and tests of students' critical thinking skills. The data analysis was done by paired sample T-Test and independent sample T-Test. While, field-testing was conducted using a pretest-posttest control group experimental

design. The experiments on the implementation of conductivity practicum equipment were conducted on two classes. First class was taught by the researchers and second class by other teachers. A pretest was done before the implementation and post-test were done after. The tests' questions are designed to measure students' critical thinking skills. The research design used is described in Table 1.

Table 1. Pre-test and post-test group design

Group	Pre-test	Treatment	Post-test
VII A	O ₁	X ₁	O ₂
VII B	O ₁	X ₂	O ₂

Explanation:

O₁ = Pre-test before treatments.

O₂ = post-test after treatments.

X₁ = learning activity using the developed heat conductivity equipment in the heat transfer material. The researcher acts as the teacher.

X₂ = learning activity using the developed heat conductivity equipment in the heat transfer material by the actual teacher.

Treatments were given to the first and second experimental classes. They were given the same treatment using heat conductivity equipment as the result of the development. The first experimental class was taught by the researcher and the second experimental class was taught by the native teacher of the school.

RESULT AND DISCUSSION

The equipment was made using simple materials. It was designed to compare the ability of three different metals in terms of length and diameter in transferring heat, and also to determine the rate of heat transfer of each metal. The source of heat was three electrical solders, the position of thermometers in each metal can be manipulated so that the change in temperature can be observed. The developed product was accompanied by inquiry-based student worksheet. The critical thinking ability can be

measured by the result of pre-test and post-test. The tests' specification was constructed based on the students' ability in giving argument, deduction, evaluation based on the information gained and the process of critical thinking is implementing the result.

The final product had been revised several times through the advisors, expert validation, and peer-assessment toward the usefulness, feasibility, and the practicality of the product. The display of the product viewed from different angles can be seen in the following figures:

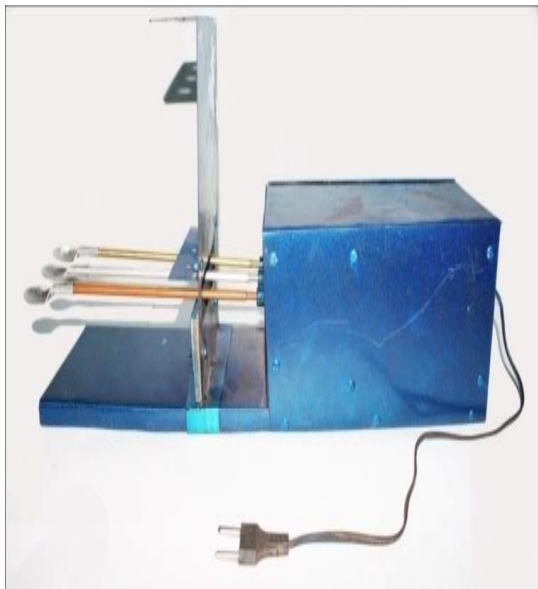

Figure 1. Side-view of the product

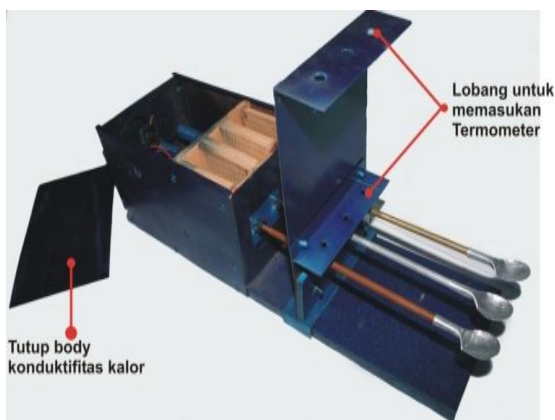

Figure 2. Top-view of the product with an opened case

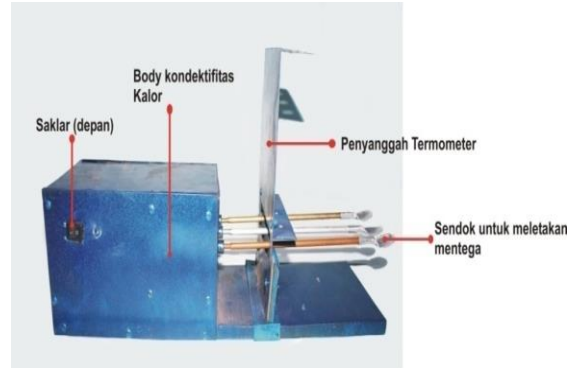

Figure 3. Side-view of the product

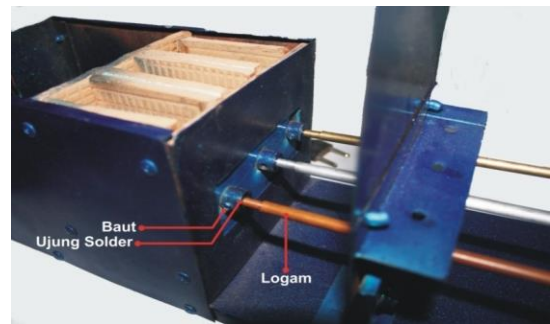

Figure 4. Metal connector and the box

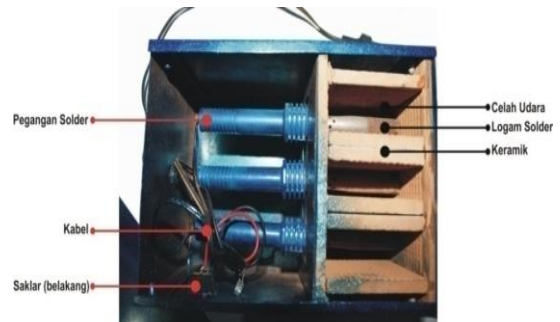

Figure 5. Top-view of the product

Table 2. Description of the parts of the product

Component	Description
Metal Solder	Three 60 Watt solders arranged in a row but given a gap.
Vent	To prevent over-heating.
Ceramic	To prevent the heat to spread to the side of the box.
Switch	To connect the electric current.
Wire	Distributing power source to solder.
Tip of metal solder	To connect metal for observations

Bolt	Bolt to tighten metal position attached to the tip of solder.	Product development results then further tested before being implemented. The first experimental tool test is done by experts, then the individual, a then small group to know the application of product development in learning. The results of this small group testing were used to find out the students' responses to the use of the product. The initial product validation by a science expert to assess the suitability of the tool development with the objective the data is shown in Table 3
Spoon	Used to put butter for heat indicator. If the heat spreads to the side, the butter will melt, because butter is very sensitive to heat.	
Thermometer holder	To make it easier to measure the temperature change between the metal attached to the solder with metal close to the spoon.	

Table 3. The testing result from the expert of construction, the expert of heat conductivity equipment, and the content of practicum guide

Type of Validation	Validator 1	Validator 2	Validator 3	Average
The construction of the product	3,27	3,27	3,09	3,21
The materials of the product	3,09	3,45	3,00	3,18
The construction of the worksheet	3,26	3,63,	2,95	3,28
The content of worksheet	3,13	3,67	2,93	3,24

Table 4. Conversion of the assessment Score into Statement

Score	Statement
$3,25 < \bar{x} \leq 4,00$	Very Good
$2,50 < \bar{x} \leq 3,25$	Good
$1,75 < \bar{x} \leq 2,50$	Poor
$1,00 < \bar{x} \leq 1,75$	Very poor

Based on Table 3 and Table 4, can be concluded that for construct, material of

product, and students worksheet is “Good criterion”. The practitioners’ validation connects to construct and material product also student’s worksheet. Through peer to peer test, scoring from practitioners by two teachers who teach science in Junior High School shown in Table 5 as users. Small group product test is shown in Table 6.

Table 5. Small group test result of construction and experts test of heat conductivity product and practicum content guide

Type of validation	Average score from the first ad the second teacher	Kriteria
The construction of the product	3,50	Very Good
The materials of the product	3,50	Very Good
The construction of the worksheet	3,00	Good
The content of worksheet	3,10	Good

Table 6. The result of small-group testing

Aspects	Heat conductivity equipment		Practicum guide	
	Score	Criteria	Score	Criteria
Attractiveness	88	Very attractive	84	Very attractive
Practicality	85	Very practical	89	Very practical
Usefulness	97	Very usefull	86	Very usefull
Total	90		86	

Based on the results of small group testing on attractiveness, practicality, and usefulness of the developed product, it was obtained the score 90% and 86% on the heat conductivity equipment and the practicum guide. This data shows students' responses that provide excellent product grades to be applicable in learning.

In relation to attractiveness, practicality, and usefulness, the test was conducted to 60 students of Blambangan Umpu State Junior High School of VII A and VII B class shown in Table 7.

Table 7. The result of attractiveness, practicality, and usefulness of the developed product.

Aspects	Heat conductivity equipment		Practicum guide	
	VII A	VII B	VII A	VII B
Attractiveness	88	87	81	82
Practicality	71	75	74	88
Usefulness	95	89	82	92
Total	78	87	75	89

Based on the data, the result of attractiveness, practicality, and usefulness according to the student's responses reached an average score of 77% with good criterion. Practical guide in the form of worksheet got 88% of student appraisal with the very good criterion. This is relevant with the opinion that stated that the practicum equipment accompanied by practicum guide hold some benefits such as: clarify the information so that there is an increase in learning outcomes, improve motivation to learn, interact directly with the students environment in its own way based on the ability and interest, with the limitations of the five senses, time and space and to provide the same experience for all students as well as the emergence of direct interaction with teachers, community, and even the environment.

Adegoke & Chukwunonye states that hands-on experiments are preferred because they bring students directly to real-life phenomena and can train students'

creativity (Adegoke & Chukwunonye, 2013). Meanwhile, according to Popescu & Morgan, the delivery of Physics learning should be as much as possible to bring children into real life, because by using real situations, students will find physics more relevant so that they will be more involved and motivated in class (Popescu & Morgan, 2007).

The effectiveness test in the use of heat conductivity practicum equipment based on the cognitive aspect of students in class VII A and VII B at State Junior High School 3 Blambangan Umpu, Way Kanan was determined based on normalized N-gain by comparing the score of pretest and posttest done by the students

The effectiveness test was conducted on the science course of heat transfer lesson which was conducted through written test. The tests were given in the form of 6 essay questions and each correct answer worth 10 points. The N-gain value obtained from the two treatment classes was expected to obtain the same score. Based on the research results, the data obtained are shown in Table 8.

Table 8. the result of critical thinking tests

Type of test	Class VII A	Class VII B
Pre-Test	35.419	34.310
Post-Test	81.548	79.310
Normalized N-gain	0.706	0.700

It was expected that the result of the effectiveness test to achieve a comparable effectiveness score between the two experimental classes. A statistical test was needed to prove the hypothesis that the N-gain increase was the effect of using the developed heat conductivity equipment. Data analysis was done based on N-gain result obtained from field testing in two classes with the different teacher, but the process of learning was using the same lesson plans.

The average result of the N-gain value of class VIIA and VIIB of State Junior High School 3 Blambangan Umpu was

0.706 and 0.700 respectively. N-gain was > 0.7 which means a high level of effectiveness in fostering students' critical thinking skills through the use of heat conductivity tools in science lessons existed.

Assessment of effectiveness in the use of the developed equipment was done in order to increase the ability to think critically of the students in the two research classes. A t-test was done using a normal and homogenous data. Tests on the N-gain aim to determine that there is no difference in N-gain values in the two classes even though they are taught by different teachers. The results of the statistical analysis test are presented in Table 9.

Table 9. The N-gain value of the students of class VIIA and VIIB of State Junior High school Blambangan Umpu

Test	t-test			Result
	t-critical	t-table	Sig	
N-gain	0.107	0.678	0.915	$t_{value} < t_{table}$ Ho is accepted

Based on the calculation, it was obtained sig value of 0.915 which is greater than α 5%, which means H_0 is accepted. This test proved that there was no difference of N-gain value between class VIIA and VIIB that receive the treatment. The increase in N-gain value was as the impact of the use of heat conductivity equipment in the practicum that was able to foster the students' critical thinking skills.

CONCLUSION AND SUGGESTION

Conclusion

Heat conductivity equipment produced for the seventh-grade students on heat transfer material that can compare the heat conductivity capability of 3 different metal types, even the students were able to find the value of heat transfer rate of copper, aluminum, and brass. The equipment is equipped with an inquiry-based worksheet

as a guide that can foster the students' critical thinking ability. The attractiveness, practicality and usefulness of heat conductivity equipment and the guide received excellent response from the students by 88% and 89%.

The effectiveness of the developed product toward the students' critical thinking ability in class VII A and VII B in State Junior High School 3 Blambangan Umpu Way Kanan obtained the N-gain value of 0,700. This shows a high effectiveness value. Thus, the heat conductivity equipment can work well to be utilized in learning by following procedures in accordance with the worksheet that has been prepared to foster the students' critical thinking ability.

Suggestion

The development of heat conductivity equipment is expected to be further researched in a wider range of functions, not only for heat transfer materials but also for temperature changes such as the length expand of a metal.

REFERENCES

Abdurrahman. (2017). Efektivitas dan Kendala Pembelajaran Sains Berbasis Inkuiri terhadap Capaian Dimensi Kognitif Siswa: Meta Analisis. *Tadris: Jurnal Keguruan Dan Ilmu Tarbiyah*, 2(1), 1–9. <https://doi.org/https://doi.org/10.24042/tadris.v2i1.1206>

Abdurrahman, A., Saregar, A., & Umam, R. (2018). The Effect of Feedback as Soft Scaffolding on Ongoing Assessment Toward The Quantum Physics Concept Mastery of The Prospective Physics Teachers. *Jurnal Pendidikan IPA Indonesia*, 7(1), 41–47. <https://doi.org/10.15294/jpii.v6i2.7239>

Adegoke, B. A., & Chukwunenye, N. (2013). Improving Students'

- Learning Outcomes In Practical Physics , Which Is Better ? Computer Simulated Experiment or Hands-On Experiment ? *Journal of Reserch & Method in Education*, 2(6), 18–26.
- Anwar, C. (2017). The Effectiveness of Problem Based Learning Integrated With Islamic Values Based on ICT on Higher Order Thinking Skill and Students' Character. *Al-Ta Lim Journal*, 23(3), 224. <https://doi.org/10.15548/jt.v23i3.244>
- Asyhari, A., & Hartati, R. (2015). Implementasi Pembelajaran Fisika SMA Berbasis Inkuiri Terbimbing Terintegrasi Pendidikan Karakter untuk Meningkatkan Hasil Belajar Siswa pada Materi Cahaya dan Optika. *Jurnal Ilmiah Pendidikan Fisika Al-Biruni*, 4(1), 37–49.
- Bell, T., Urhahne, D., & Schanze, S. (2013). Collaborative Inquiry Learning: Models , tools , and challenges. *International Journal of Science Education*, 32(3), 349–377. <https://doi.org/https://doi.org/10.1080/09500690802582241>
- Dewi, P. S. (2016). Perspektif Guru sebagai Implementasi Pembelajaran Inkuiri Terbuka dan Inkuiri Terbimbing terhadap Sikap Ilmiah dalam Pembelajaran Sains. *Tadris: Jurnal Keguruan Dan Ilmu Tarbiyah*, 1(2), 179–186.
- Diana Putri, S., & Djamas, D. (2017). Pengembangan Perangkat Pembelajaran Fisika Berbasis Keterampilan Berpikir Kritis dalam Problem-Based Learning. *Jurnal Ilmiah Pendidikan Fisika Al-Biruni*, 6(1), 125–135. <https://doi.org/https://doi.org/10.24042/jpifalbiruni.v6i1.648>
- Inzanah, Ibrahim, M., & Widodo, W. (2014). Pengembangan Perangkat Pembelajaran IPA Berbasis Kurikulum 2013 untuk Melatih Literasi Sains Siswa SMP. *Pendidikan Sains Pascasarjana Universitas Negeri Surabaya*, 4(1), 549–567.
- Lastriningsih, L. (2017). Peningkatan Berpikir Kritis dan Prestasi Belajar Melalui Metode Inquiry pada Siswa Kelas IV SD. *Jurnal Prima Edukasia*, 5(1), 68–78.
- Latifah, S. (2015). Pengaruh Model Pembelajaran Kooperatif Tipe Time Token Berbantu Puzzle terhadap Kemampuan Berpikir Kritis Peserta Didik Kelas X pada Materi Gelombang. *Jurnal Ilmiah Pendidikan Fisika Al-Biruni*, 4(1), 13–23.
- Maulida, D. R., & Kusumaningtyas, D. A. (2017). Efektivitas Kegiatan Praktikum terhadap Hasil Belajar Fisika Kelas X pada Materi Asas Black di SMA Muhammadiyah 4 Yogyakarta Tahun Ajaran 2015 / 2016. *Jurnal Penelitian & Pengembangan Pendidikan Fisika*, 3(1), 43–48.
- Nisa', A., Sudarmin, & Samini. (2015). Efektivitas Penggunaan Modul Terintegrasi Etnosains dalam Pembelajaran Berbasis Masalah untuk Meningkatkan Literasi Sains. *Unnes Science Education Journal*, 4(3), 1049–1056.
- Nuriyatin, S., & Hartono, H. (2016). Pengembangan Pembelajaran Penemuan Terbimbing untuk Meningkatkan Berpikir Kritis dan Motivasi Belajar Geometri di SMP. *PYTHAGORAS: Jurnal Pendidikan Matematika*, 11(2), 207–218. <https://doi.org/https://doi.org/10.21831/PG.V11I2.10656>
- Popescu, A., & Morgan, J. (2007). Teaching Information Evaluation and Critical Thinking Skills in Physics Classes. *American Assosiation of Physics Teachers*, 507(45), 507–510. <https://doi.org/https://doi.org/10.1119/1.2798365>
- Rokhimi, I. N., & Pujayanto. (2015). Alat Peraga Pembelajaran Laju Hantaran

Kalor Konduksi. *Prosiding Seminar Nasional Fisika Dan Pendidikan Fisika (SNFPF)*, 6, 270–274.

Saregar, A., Marlina, A., & Kholid, I. (2017). Efektivitas Model Pembelajaran ARIAS ditinjau dari Sikap Ilmiah: Dampak terhadap Pemahaman Konsep Fluida Statis. *Jurnal Ilmiah Pendidikan Fisika Al-Biruni*, 06(2), 255–263. <https://doi.org/10.24042/jipfalbiruni.v6i2.2181>

TREND ANALYSIS OF PHYSICS PROSPECTIVE TEACHERS' RESEARCH: AN EFFORD TO IMPROVE THE ACADEMIC QUALITY OF PHYSICS STUDY PROGRAM

Muhammad Minan Chusni*¹, Rizki Zakwandi²

^{1,2} Physics Education, Tarbiyah and Teacher Training Faculty, UIN Sunan Gunung Djati Bandung, Indonesia

*Correspondence address: minan.chusni@uinsgd.ac.id

Accepted: November 16th, 2017. Approved: April 2nd, 2018. Published: April 29th, 2018

Abstract: Research should be focused on topics that are appropriate to the needs of the times so that the results of the research can be applied. Students in completing their studies are required to make final assignments in the form of research. Therefore, this study aims to identify the tendency of research of the Physics Education students Indicator the last five years and to determine the theme of educational research studies that allows for further study by Physics Education students in the future. This research was conducted in physics education program with research objects were taken from the written thesis of 2013 until 2017. This research design is a case study with data analysis technique of descriptive qualitative and quantitative. this study found the theme of research studies most studied by Physics Education students were a model of learning and research studies that may still be studied further, namely the evaluation of learning, learning media, and learning strategies on subjects other than temperature and heat and static fluids. The results of this study can be used as a consideration to determine the topic of the thesis and reduce the risk of plagiarism and increase the variety of research in the environment of the study program.

© 2018 Physics Education, UIN Raden Intan, Lampung, Indonesia.

Keywords: Physics Research, Research, Students' Researchers, Trend analysis

INTRODUCTION

Science education is an education with an orientation to make learners possess a scientific attitude after finishing the learning. Some of the scientific attitudes required after implementing science learning are objective, skeptical, rational, critical, analytical, and evaluative mindset that can be embodied in scientific research. Many curricula try to direct learners to conduct scientific research during the learning process. In Indonesia, the curriculum guides learners to think scientifically and to conduct researches as a result of the new learning at university level. In carrying out the research, basically, there are some observed signs called the ethics of scientific papers which includes originality, scientific wisdom, honesty, repeatability and appreciation to others and nature. Related to the factor of repeatability of a research where the focus of research is to analyze the level of repetition and variation of originality of

research done by senior students in physics education department.

Research of education is generally difficult to implement because of three things, (1) the concept of research is complicated; (2) several theories of education are contradictive; (3) involves the human factor which is a difficult variable to control, unlike science, although there are many variables involved, but they are relatively easy to control, as in the experiment (Setyosari & Punaji, 2016). The difficulty of variable control is caused by subjects that cannot be controlled completely. This is because human nature is not constant and will be very easily changed by something very simple, such as lack of rest, body condition, or other factors such as the stress caused by the pressure of learning is too heavy. This factor will cause an error of the result of the measurement to be generalized. This will be different when

the object of research is in the form of inanimate objects.

However, research in the field of education is very important, because we cannot continue to depend on feelings and experience alone to improve the quality of education. The data obtained are then analyzed and interpreted. The research results can be used to address educational issues (Kitto et al., 2015). The results of educational research can provide an overview, explanation, prediction, innovation and theoretical foundations for educational development (Kyriakides, Creemers, & Charalombous, 2018; Sukmadinata, 2009).

Along with the advancement of times, the theme of the research will also change according to the development of the era itself. Some developments of such phenomena tend to be centered on research methods, and the field of study tentatively arises and disappears (White, 1997). The type of research that focuses on research methodology has shifted from experimental research into qualitative descriptive research using data as a result of observation and not from the result of the evaluation (Wang, Ho, Chen, & Cheng, 2015).

Changes in the focus of research subject beginning in the 1980s to 1990s. In the 1980s the subjects of the research were the learners, especially on understanding the concept of learners. While in the 1990s the subjects of research were more focused on constructivism and contextual approach (Duit, 2007). Now in the 2000s there are nine categories of topics that interest the researchers, they are (1) understanding the concept of science; (2) learning practices; (3) concept change and concept mapping; (4) professional development; (5) change of concept and analogy; (6) the nature of science and social issues; (7) reasoning and problem-solving skills; (8) education in urban-based design; (9) attitude and gender. The most studied topics were the topic of concept change and concept

mapping, but the numbers experienced a slight decline in the 2000s. The thesis is one of the basic courses of education that must be faced and must be passed by every graduate students of Physics Education Study Program UIN Sunan Gunung Djati Bandung. This course produces one of the research products in the form of scientific papers that become the highest achievement to complete the education level. The purpose of this course is to provide students with direct experience of knowledge, skills, and attitudes in conducting research in the field of education.

Students who will take the course of the thesis must meet several requirements such as the number of credits that have been taken to reach 140 credits point and has passed the course of Research Methodology of Physics Education. This is because the prerequisite subject is a basic provision of research steps, types of research, research methods, and processing and analysis of research data.

Based on preliminary observations made by researchers on the thesis of Physics Education Student UIN Sunan Gunung Djati in the last five years (2013-2017) showed very diverse results. The diversity has not been identified in detail, so the exact trend direction is not known. Meanwhile, information about trends in a research is very important to be known in order to trace the factors that influence it to become important information in policy-making related to academic quality improvement.

Analysis of students' thesis allows the development of research themes, an extension of a subject, and updating of research variables that allow for further study by students. If the issue of education that can be studied by students is rich Indicator numbers, it will make it easier for the students to determine the theme of the study so that students can immediately complete the study on time. This will indirectly support the accreditation

improvement of Physics Education Study Program on the standard 3 of students and graduates because one of the indicators is the existence of a timely study period. It will also improve the quality of Physics Education graduates as a prospective teacher in Senior High Schools and Islamic Senior High Schools.

As discussed in the aforementioned section of the above discussion, the problems to be solved in this research are: (1) Identification of research tendency of Physics Education student during the last 5 years; (2) Which research subject that is possible to be studied further by Physics Education students in the coming period?

The purpose of this study are (1) To identify the tendency of research Physics Education students during the last 5 years; (2) To determine the theme of the study of educational research that allows for further study by Physics Education students in the future.

The research that researchers have done focuses on physics education students' research documented from 2012 to 2017 and has not been done since the opening of physics education program until now. The results of this study become important because it can map the theme of research studies that have been studied too much and the theme of the study is still rarely studied so that it can provide input for improving the management and implementation of physics education academic activities.

THEORETICAL FRAMEWORK

Research is an activity that is done by following scientific principles. A study can be done individually or in groups. In doing scientific research, there are some rules that must be considered by the researchers, namely: Original, Need / Important, Scientific, Consistent (Yudistira & Dadang, 2012). Originality means that any research done should not replicate or repeat similarly to the research of others (previous researchers). In the

ethics of scientific work, this will also be related to the factor of plagiarism. A good study is research that comes from a new idea. The degree of originality of a study will determine the quality of the research conducted (Winfrey, 2017). An important aspect of the research shows the use of the current research. This is related to the target and the possible form of implementation of the research results. In the world of research, an education conducted should lead to implementation at the school level. This means that the results of research that has been done can be used to support the process and learning outcomes (Setyosari & Punaji, 2016). Scientific is the nature of a research article. Without scientific aspects, the result of a study will be questioned. scientific aspects include the empirical factors of a study. Research made from fictitious data will be a public fraud so it will get researchers into the realm of law. As well as the last aspect of the research implementation to be reviewed is the consistency of the research results. Consistency in terms of research results obtained can be done by others if they follow the same way to support learning (Yudistira & Dadang, 2012).

METHOD

The method used in this research was the descriptive method. The descriptive research aims to describe precisely the properties of a particular individual, state, phenomena, or group, or to determine the frequency or spread of a phenomenon or the frequency of a particular relationship between a phenomenon and another phenomenon in society (Veal, 2017).

This research was conducted in Physics Education Study Program UIN Sunan Gunung Djati Bandung with 406 theses written by the students within 5 years period (2013-2017) as the object of the research. The procedure of this research was to identify, analyze and map the results of students' research during the last 5 years. Based on the procedure, this

research was conducted using a case study research design (Johnsons & Christensen, 2008). The variables in this study were the identification and mapping of the theme of research, the variables studied, and the subject studied.

Data collection employed was non-test techniques through document analysis. All data collected were then analyzed through the following steps: 1) data collection; b) data grouping; c) Descriptive quantitative and qualitative analysis and d) result interpretation (Sugiyono, 2014).

The data analyzed in this research included research theme, research topic and also subject matter raised in research. The analysis is related to the distribution and variation of the data, the causes and

advantages and disadvantages of the research findings.

RESULTS AND DISCUSSION

During the last five years (2013 - 2017) 395 theses of Physics Education Study program has been produced. Several findings based on case study analysis that has been done by the researcher can be described as follows:

The theme of the research study

The theme of the study selected by Physics Education students can be grouped into seven categories: evaluation, media, methods, model, approaches, learning materials, and learning strategies. The results of the identification can be seen in Table 1.

Table 1. The Data of Research Themes

No	Category	Number	Percentage
1	Learning Evaluation	18	4.56%
2	Learning Media	36	9.11%
3	Teaching Method	18	4.56%
4	Teaching model	276	69.87%
5	Approach	15	3.80%
6	Learning Material	19	4.81%
7	Strategy	13	3.29%
Total		395	100%

The data in Table 1 shows that the tendency of Physics Education students tends to study about the learning model with the percentage of 69.87% and the other still very little ranged between 3% - 9%. This shows that the variation and diversity of the research type are still at a very low level. The piled theme of research on one theme can indicate that the direction of the graduate product becomes uniform and more likely to be the fabrication of graduates (De Mauro, Greco, & Grimaldi, 2015). Based on the data obtained there are only seven main themes with a very significant percentage difference whereas 11 students took different themes with others so that in this

discussion is not the focus of research. In addition to the indication of graduate fabrication, the less diverse research themes raised may also indicate that the available educators are also less diverse. This is of course based on the selection of research titles that are based on the capabilities of mentors in guiding the students. The weakness of the accumulation of research themes usually occurs in research instruments that have a large indication of the results of plagiarism, because basically the research instrument to follow the type of research in this case related to the theme of research. The challenge that arises is to open the opportunities for research on the theme of

the study. Even on the theme of curriculum study, learning, laboratory management has not been done at all.

The data in Table 1 can be presented in Figure 1. The results of interviews with several advisors provided a different analysis of the accumulation on a research theme. Based on the results of the interviews it was found out that the theme of learning model is suitable for undergraduate students (S-1) since the purpose of the research for undergraduate students is to exercise and implement what

has been studied. So by using the learning model as a theme, the students can use all learning components such as Lesson Planning, Assessment, learning interaction and other learning components. The research of learning model also has a very close relationship with learning so that by varying the learning model the students can improve the effectiveness of learning because basically, the learning model focuses on the interaction in the learning process (Rerung, Sinon, & Widyaningsih, 2017).

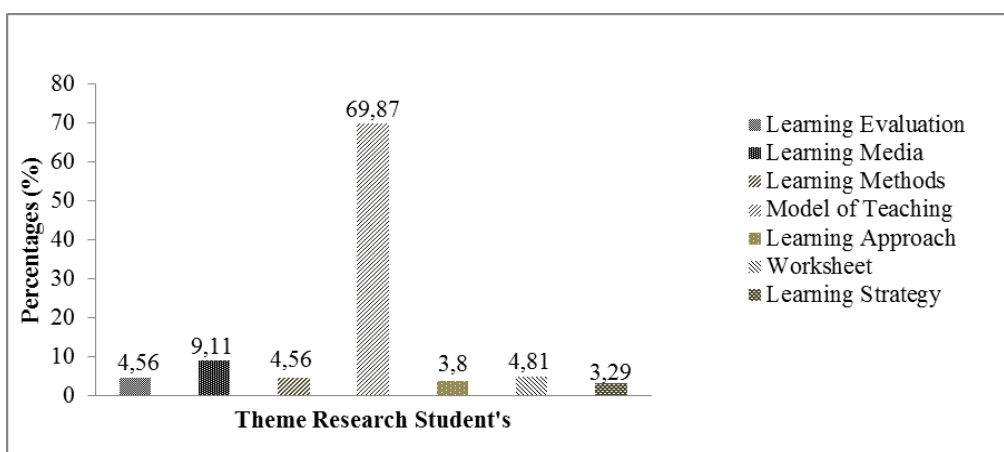

Figure 1. The Distribution of Research Theme

Research variables

The variables studied by Physics Education Study Program students for five

years have been identified and grouped in the following Table

Table 2. The Data Of Research Variable

No	Variable	Number	Percentage
1	Creative Thinking	18	4.43%
2	Critical Thinking	71	17.49%
3	Learning Barriers	7	1.72%
4	Learning Outcome	49	12.07%
5	Collaboration	1	0.25%
6	Analytical Skills	2	0.49%
7	General skill	3	0.74%
8	Arguments skill	4	0.99%
9	Scientific thinking	1	0.25%
10	The generic science skills	9	2.22%
11	Process skill	40	9.85%
12	Science literacy	43	10.59%

No	Variable	Number	Percentage
13	Problems solving	19	4.68%
14	Conceptual understanding	128	31.53%
Total		395	100%

Based on the data obtained in table 2 it is known that variations of research variables that have been done more than the theme of research. The tendency of student research variables leads to the mastery of the concept with a percentage of 31.53%; this is relevant to the statement by (Duit, 2007) that the focus of the object of research is understanding the concept of learners. Mastery of the concept itself indicates how learners (research subjects) capture the main information (essence) of physics learning (Sari, Suyanto, & Suana, 2017). Based on the background of students' research, the mastery of the concept is chosen to be the research variable based on the issues of physics learning found in the majority field using mathematical approach.

Furthermore, the tendency of research variables is critical thinking. It is also in accordance with the research that

has been done by (Chang, Chang, & Tseng, 2010) that research issues that are popular are about reasoning skills and problem-solving. The ability to think critically becomes one of the hot topics of research along with the emergence of new phenomena and has anomalies with events in general. In the field of physics, the new phenomenon becomes a subject that needs to be improved, especially to learners. In addition, the tendency of research towards critical thinking aims to prepare learners to a higher level, i.e., universities which are critically desirable personalities in both scientific and socio-political and social issues (Klening, 2018).

Referring to the data contained in table 2, the other research variables are still relatively low, so the opportunity to conduct such researches is still open. In more detail, the data in Table 2 can be presented in Figure 2.

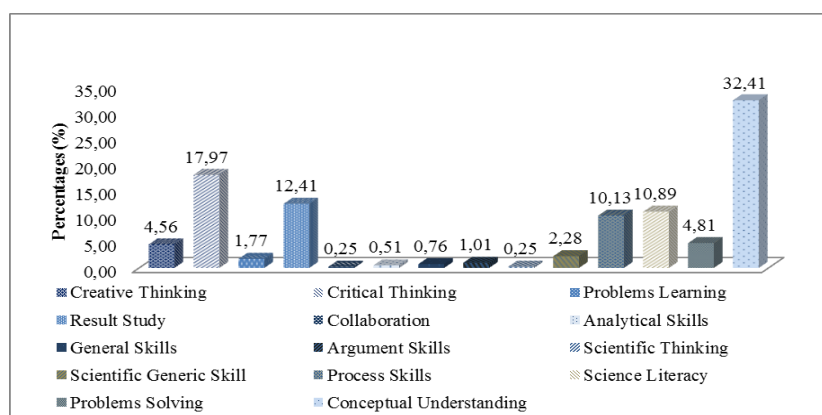

Figure 1. The distribution of research variables

Subject to physics

There is a tendency in the research of Physics Education Study program students that they tend to focus on a certain subject and there is no equality on other subjects.

This fact can be seen from the distribution of physics subject on the students' research as shown in Table 3.

Table 3. The data of physics research subject

No	Physics Subjects	Quantity	Percentage
1	Quantity and units	3	0.76%
2	Soundwave	6	1.52%
3	Particle dynamics	2	0.51%
4	Rotational dynamics	1	0.25%
5	Renewable energy	3	0.76%
6	Elasticity	12	3.04%
7	Basic physics	4	1.01%
8	Advanced physics	3	0.76%
9	Modern physics	1	0.25%
10	Dynamics fluids	13	3.29%
11	Static fluid	65	16.46%
12	Electromagnetic wave	3	0.76%
13	Oscillation	2	0.51%
14	Linear motion	18	4.56%
15	Rotational motion	2	0.51%
16	Wave and vibration	16	4.05%
17	Newton's law of motion	7	1.77%
18	Momentum and impulse	7	1.77%
19	Rigid bodies	2	0.51%
20	Electrodynamics	16	4.05%
21	Electrostatics	10	2.53%
22	Disaster mitigation	3	0.76%
23	Optics	28	7.09%
24	Global warming	4	1.01%
25	Natural resources	5	1.27%
26	Heat and temperature	85	21.52%
27	Pressure	22	5.57%
28	Atomics theory	1	0.25%
29	Thermodynamics	6	1.52%
30	Force and Energy	26	6.58%
31	Vector	5	1.27%
32	Matter and their phase	14	3.54%
Total		395	100%

Table 3 shows that the subjects of physics as the research focus of the Physics Education Study Program Students have not been equally spread for the last five years. The most frequent subjects were temperatures and heat (21.52%), static fluids (16.46%), while atomic physics, modern physics, rigid bodies and rotational dynamics are still rarely studied

by students. One of the considerations in choosing the material used as the subject matter of the research is the availability of the material within the scope of its implementation. The results of the investigation on the distribution of the material on which the subject is based are that the tendency of students to choose the material available in the even semesters

compared with the material in the odd semesters. In addition, based on the data obtained, it can be seen that the level of material complexity is also a consideration of choosing the material (Thomas, 2017). Table 2 shows that abstract materials have a smaller percentage compared to more general materials.

Temperature and heat itself are one of the materials contained in the second semester of X grade on the KTSP curriculum while in the National Curriculum, this material is contained in the first semester of XI grade. Based on the research analysis ranging from 2012 to 2017, the majority of schools were still applying the KTSP curriculum (School-based Curriculum).

CONCLUSIONS

Based on the analysis of the research data and identification of the thesis of Physics Education Study Program for the last five years, it can be concluded that (a) The research subject of the research most studied by the students of Physics Education Study Program is the learning model, (b) evaluation of learning, learning media, and learning strategies, and the subjects other than temperature and heat and static fluids are the topics that still need to be studied further.

SUGGESTIONS

The suggestions from the results of this study are (a) This mapping can be used as a reference for the management of thesis in Physics Education Study Program in order to direct the student's research so that quality works can be produced, (b) Lecturer of academic Advisors and thesis Advisors should know the mapping of thesis research so that they can guide the students to choose a research that has not been studied and to avoid repeated research.

The limitations of this study are that the data sources were only taken from research titles, while the primary sources

of interviews with researchers and advisors have not been done thoroughly. The further researches can be done by considering the methodology and data collection techniques presented as well as variations of research sites.

REFERENCES

- De Mauro, A., Greco, M., & Grimaldi, M. (2015). Is what big data? A consensual definition and a review of key research topics. *AIP Conference Proceedings*, 1644(1), 97–104. <https://doi.org/10.1063/1.14907823>
- Duit, R. (2007). Science Education Research Internationally: Conception Research Methods, Domain of Research. *Eurasia Journal of Mathematics, Science & Technology Education*, 3(1), 3–15.
- Johnsons, B., & Christensen, L. (2008). *Educational Research: Quantitative, Qualitative, and Mixed Approach 3rd Edition*. Los Angeles: SAGE Publications.
- Kitto, S., Goldman, J., Etchells, E., Silver, I., Peller, J., Sargent, & Bell, M. (2015). Quality improvement, patient safety, and continuing education: a qualitative study of the current boundaries and opportunities for collaboration between these domains. *Academic Medicine*, 90(2), 240–245.
- Klening, J. (2018). Trust and Critical Thinking. *Educational Philosophy and Theory*, 50(2), 133–143. <https://doi.org/10.1080/00131857.2016.114416>
- Kyriakides, L., Creemers, B., & Charalombous, E. (2018). The Impact of the European School Improvement Study on Quality an Equity in Education. *Equity and Quality Dimensions in Educational Effectiveness*, 151–180.
- Rerung, N., Sinon, I. L. S., & Widyaningsih, W. (2017). Penerapan model pembelajaran problem based

- learning (PBL) untuk meningkatkan hasil belajar peserta didik SMA pada materi usaha dan energi. *Jurnal Ilmiah Pendidikan Fisika Al-BiRuNi*, 6(1), 47–55.
<https://doi.org/10.24042/jipfalbiruni.v6i1.597>
- Sari, W. P., Suyanto, E., & Suana, W. (2017). Analisis Pemahaman Konsep Vektor Pada Siswa Sekolah Menengah Atas. *Jurnal Ilmiah Pendidikan Fisika Al-BiRuNi*, 6(2), 159–168.
<https://doi.org/10.24042/jipfalbiruni.v6i2.1743>
- Setyosari, & Punaji, H. (2016). *Metode Penelitian Pendidikan & Pengembangan*. Jakarta: Penada Media.
- Sugiyono. (2014). *Metode Penelitian Kuantitatif Kualitatif dan R & D*. Bandung: Alfabeta.
- Sukmadinata, N. S. (2009). *Metode Penelitian Pendidikan*. Bandung: Rosda Karya.
- Thomas, G. (2017). *How to Do Your Research Project: A Guide for Student*. London: Sage Publication Ltd.
- Veal, A. J. (2017). *Research Methods for Leisure and Tourism*. The UK: Pearson.
- Wang, C. ., Ho, H. ., Chen, L. M., & Cheng, Y. Y. (2015). The Trend of Research in Educational Psychology. *Jiaoyu Yanjiu Yueken, Journal of Education Research*, 252(80), 80–96.
- White, R. (1997). Trends in Research in Science Education. *Research in Science Education*, 27(2), 215–221.
- Winfrey, J. (2017). Physics education research and student development. *Physics Today*, 70(2), 1–10.
- Yudistira, & Dadang, H. (2012). *Menulis Penelitian Tindakan Kelas yang APIK*. Jakarta: PT. Grasindo.

STUDENTS' ABILITY IN SOLVING PHYSICS PROBLEMS ON NEWTONS' LAW OF MOTION

Supeno*¹, Subiki², Laili Widya Rohma³

^{1,2,3} Physics Education, Faculty of Teacher Training and Education, University of Jember, East Java, Indonesia.

*Correspondence address: supeno.fkip@unej.ac.id

Accepted: December 7th, 2017. Approved: March 26th, 2018. Published: April 28th, 2018

Abstract: The ability to solve physics problems is one of the goals in learning physics and a part of the current curriculum demands. One of the physics problems that are often the focus of attention in learning is Newton's law of motion. When solving physics problems on Newton's law of motion, students need to utilize various aspects of certain abilities and rules. The purpose of this study was to reveal how the students utilized aspects of the abilities and rules in problem-solving. The study was conducted by providing physics problems on Newton's law of motion to 105 high school students. The result showed that most students were able to write equations, solutions, and system of units correctly for each problem. However, students' ability to determine the coordinate axes, depicts free-body diagrams, forces representation, and determine the resultant forces and direction of motion was unsatisfactory. Students tended to refer to the mathematical formulations in solving the problems. Therefore, physics learning that requires students to actively learn collaboratively, peer instruction, and procedural thinking can be used as an alternative learning strategy to overcome said problems.

© 2018 Physics Education, UIN Raden Intan, Lampung, Indonesia.

Keywords: Problem-solving, free-body diagrams, representation of forces.

INTRODUCTION

The ability to solve problems is one of the goals in learning physics. This is stated in the existing curriculum in Indonesia nowadays, one of the competencies that must be achieved by students in learning physics is problem-solving (Kemendikbud, 2016). Some researchers argue that the students' ability in problem solving is an important goal in learning science, including physics (Duschl, Schweingruber, & Shouse, 2007; Gok, 2015; Hong, Chen, Wong, Hsu, & Peng, 2012) because problem-solving is an important cognitive activity in the learning process (Bogard, Liu, & Chiang, 2013; Jonassen, 2000; Kim, 2012), and these abilities are related to aspects of knowledge, thinking skills, and reasoning abilities (Chang, 2010). In addition, problem-solving is one of the current 21st-century skills (Arends, 2012; Kay, 2010). Problem-solving is recognized as a major goal, teaching strategy, and evaluation

technique in physics learning (Heller, Keith, & Anderson, 1992; Huffman, 1997). This fact shows that problem-solving ability is one of the important skills to be developed in learning physics.

Problem-solving is a thinking process that one applies in order to achieve goals different from the state of origins (Lovett, 2002). Problem-solving is one of the higher-order thinking skills (Kelly, 2005; Slavin, 2018) that can be seen as a cognitive process for obtaining a particular goal when the desired solution is not known (Santrock, 2011). Based on cognitive views, problem-solving is a cognitive and innovative process that can help to develop effective strategies to solve everyday problems (Moreno, 2010). In problem-solving, students must apply their knowledge and skills to achieve specific goals (Robertson, 2016) and use certain abilities and rules to solve problems (Mason & Singh, 2010). Problem-solving requires various cognitive components, i.e.

information, concepts, rules, and principles (knowledge domain); information networks, concept networks, and mental models (structural knowledge); arguments, analogies, and inference (implicative skills); metacognition skills; and motivational components (Jonassen & Tessmer, 1996). Teachers believe that problem solving is an important and useful skill for students in learning and thinking as a complex cognitive activity (Sabella & Redish, 2007).

One of the physics learning materials in senior high school is about the dynamics of motion. Dynamics of motion discusses the motion of an object by considering the cause of the motion. The material discussed in the dynamics of motion is about Newton's law. Students often experience difficulties when solving problems related to the dynamics of motion. Some students have difficulty in solving problems related to force (Carson & Rowlands, 2005; Matthews, 2009; Rowlands, Graham, Berry, & McWilliam, 2007) and the concept of acceleration (Coelho, 2010; Tasar, 2010). The results of the study by (Narjaikaew, 2013) showed that some students did not understand the concept of motion and force. The concept of motion and force is described as the motion of an object that is always caused by force, no force acts on a still object, and that the force influences the velocity of an object. The results of other studies showed that students' ability in solving physics problems on Newton's law of motion was unsatisfactory (Tasar, 2010; Yilmaz & Yalcin, 2012).

The ability to solve the physics problem of Newton's law is one of the goals in learning physics. For that reason, an assessment instrument is needed to measure that ability. The assessment instrument should require students to organize, select, and apply complex procedures (Slavin, 2018). Kocakullah (Kocakulah, 2010) has developed an assessment instrument to measure

students' ability to solve the problems on Newton's law of motion. The assessment instrument has been used to assess several aspects of the ability whose components include: identifying coordinate axes, drawing free-body diagrams, representing forces, determining the direction of motion based on resultant forces, write the equations and solutions, and write the system of units. The assessment instrument is based on seven steps to solve the physics problems on Newton's law of motion as suggested by Serway and (Serway & Beichner, 2000) and adapted to the problem-solving strategy developed by (Gaigher, Rogan, & Braun, 2007).

The free-body diagram is an important part of physics learning on mechanics (Serway & Jewett, 2014; Young, Freedman, & Ford, 2016) and a representation of forces acting on objects (Van den Berg & Huis, 1998). Teachers believe that free-body diagrams and forces representations are useful in learning (Wendel, 2011). The use of free-body diagrams can develop students' abilities in formulating equations of motion (Fisher, 1999). With free-body diagrams, students are aware that Newton's law of motion shows the interrelationships between vectors so that students learn to determine the resultant of forces acting on the objects and determine the acceleration of motion (Flores, Kanim, & Kautz, 2004). Students who have the ability to draw free-body diagrams are significantly capable of problems solving (Malone, 2008; Rosengrant, Van Heuvelen, & Etkina, 2009). A free-body diagram can be used to reinforce students' understanding and extend knowledge about weight, force, and vector of forces. In addition, it can help to diagnose the accuracy of motion concepts due to forces. Thus, it can be said that the free-body diagram is related to the representation of forces acting on the object, the resultant forces, and the direction of motion of the object which is all related to the student's ability to solve

the physics problems on Newton's law of motion.

Students' ability to solve physics problems can be assessed using assessment instruments. The assessment instrument developed by Kocakullah is able to reveal various aspects and levels of students' ability to solve problems (Kocakulah, 2010). However, the assessment instrument has not been widely used by teachers or researchers. For that reason, this study will assess the students' ability to solve the problems of Newton's law of motion using that assessment instrument. The purpose of this study is to reveal the students' ability to solve the problems of Newton's law of motion in terms of the ability to identify coordinate axes, draw free-body diagrams, represent forces, determine the direction of motion force, write equations and solutions, and write the system of units.

METHOD

This research was descriptive research. Herdiansyah states that descriptive research is scientific research that aims to understand a phenomenon experienced by the subject of research, such as behavior, motivation, perception, and activity (Herdiansyah, 2010). With qualitative descriptive research, researchers describe or explain the variables studied through the data obtained from the research, then

analyze and conclude them (Semiawan, 2010). Descriptive research is generally done by collecting information about the status of a situation systematically and accurately, i.e., the natural state of the research conducted (Arikunto, 2003).

The research was conducted at State Senior High School 4 Jember. The respondents of the research were 105 students of tenth grade. The research stages included: 1) determining the site of study based on several considerations, 2) making the instrument of research, i.e., the test on Newton's law of motion adapted from the test developed by Kocakullah (Kocakulah, 2010), 3) collecting the research data by giving the test on students, 4) analyzing test result data to find out students ability in solving problems, 5) drawing conclusions on the results of data analysis.

The test used was adapted from the assessment instrument and rubric to measure the problem-solving skills developed by Kocakullah (Kocakulah, 2010). The test consisted of 4 items, where the students were given a mechanical system and students were assigned to determine the dynamic quantities, i.e., the direction of motion, acceleration, tension, and the magnitude of the coefficient of friction. The mechanical system is shown in Figure 1.

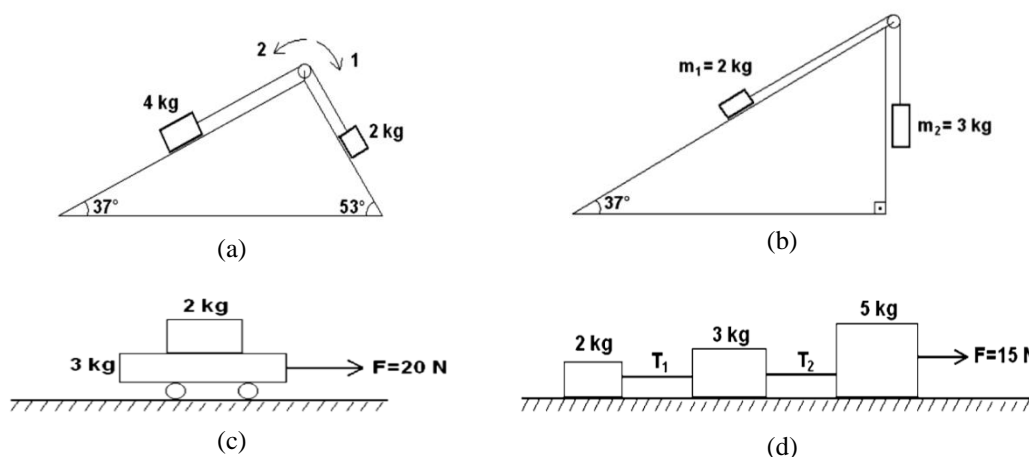

Figure 1. The mechanical systems contained in the test.

In Figure 1a (question no. 1), there were two objects on the incline, the two objects connected by a massless string. Students were assigned to determine the direction of motion and acceleration of objects. In Figure 1b (question no. 2), there were two blocks connected by a massless string, one block on the incline and the other hanging vertically. Students were assigned to determine the acceleration of the system and the force of the string. In Figure 1c (question no 3), there was a block on the train. Students were assigned to determine the minimum coefficient of friction between the carriage and the block so that the blocks stayed still on the train. In Figure 1d (question 4), there were three blocks connected by a massless string and pulled by force. Students were assigned to determine the acceleration and tension.

Data analysis was performed using tabulation to adjust the scoring table in assessment rubric (Kocakulah, 2010). The first step was to calculate the number of students according to the scores obtained on each aspect of ability. This stage was done to find out how many students were

able to solve the physics problem on Newton's law of motion in each aspect and each item. The results were then analyzed and concluded. In addition, the analysis was also done to see the correlation between aspects of ability by looking at the pattern of answers.

RESULTS AND DISCUSSION

Students Ability in Identifying Axes

The proportion of students in identifying coordinate axes when solving Newton's law of motion problems was shown in Table 1. It appears that students' ability in identifying coordinate axes was unsatisfactory. Most of the students drew mechanical systems without coordinate axes. The rest of the students drew the coordinate axes on objects in the system but were incomplete or wrong. Only 1 student was able to draw the coordinate axes completely in answer to the problem no. 3. Only 4 students drew complete and correct answer but on a certain object only, i.e., the answer to the problem no. 3 and no. 4.

Table 1. The composition of students' ability to identify axes

Description	Max Score	Number of Students			
		Problem No. 1	Problem No. 2	Problem No. 3	Problem No. 4
Axis for each object in the system was drawn completely and correctly	15	0	0	1	0
Axes for some objects in the system were drawn completely and correctly	10	0	0	4	4
Axis for each object in the system was drawn incompletely or mistakenly	5	42	37	39	50
Axes for some objects in the system were drawn incompletely or mistakenly	3	2	2	1	10
No work is done	0	61	66	60	41

Although some students drew the coordinate axes, they were generally incomplete or incorrect. The common mistake was to identify the coordinate axes of the object in the incline, i.e., the object in the problem no. 1 and no. 2. Some students did not even draw the coordinate axes for the object. For objects in the horizontal plane, i.e., in problems no. 3 and no. 4, some students drew the coordinate

axes completely but incorrectly, especially on the writing of symbols and the direction of the coordinate axis. The motion dynamics of the objects in the horizontal plane allowed students to identify the direction of the coordinate axes. Students mentioned that they were familiar with the coordinate axes of the Cartesian system, in which the x-axis was horizontal, and the y-axis was in the vertical direction.

Students Ability in Drawing Free-Body Diagrams

The proportion of students in drawing free-body diagrams is shown in Table 2. It appears that there were generally four groups of students according to their ability aspects. The first group, in which most students did not draw free-body diagrams. The second group, in which

most of the students drew free-body diagrams for systems and objects but both were incomplete. The third group, in which most of the students drew free-body diagrams, both for systems and objects, but one of them was incomplete. The fourth group, only a small part of the students, drew complete and correct free-body diagrams for both systems and objects.

Table 2. The composition of students' ability to draw free-body diagrams.

Description	Max Score	Number of Students			
		Problem No. 1	Problem No. 2	Problem No. 3	Problem No. 4
Both the system and each object of free-body diagrams were drawn	35	8	6	7	6
Minor incompleteness in both the system and objects of free-body diagrams existed	30	13	13	13	15
Each object of the free-body diagram was drawn, but the system of the free-body diagram was not	25	0	1	0	0
The system of the free-body diagram was drawn, but objects of free-body diagram were not	15	0	0	0	0
Major incompleteness in both the system and objects of free-body diagrams existed	10	25	19	24	38
Objects of free-body diagrams were incomplete, and the system of the free-body diagram was missing	5	1	0	0	0
The system of the free-body diagram was incomplete, and objects of free-body diagrams were missing	3	0	0	0	0
No work done	0	58	66	61	46

For most of the students who did not draw free-body diagrams, students answered physics problems directly using a mathematical formulation. The incompleteness of the components of free-body diagrams, both in systems and objects, was represented by drawings that used only a few forces, particularly friction forces and components of the force in the vertical and horizontal directions. In general, students only drew familiar forces. For objects that were on the incline, i.e., on the problem no. 1 and no. 2, most students only drew gravity and tension. For objects that were in the horizontal plane, i.e., on the problem no. 3 and no. 4, most students only drew gravity, normal force, and tension. The force that was often not drawn were frictional forces, pairs of action and reaction forces, and components of forces that applied to objects in the incline. For a complete free-

body diagram, students drew all the forces that worked correctly on both the system and the object, including the suitability of the force with the coordinate axes, the direction and magnitude of the force, and symbols of force.

Students Ability in Representation of Forces

The proportion of students in representing the forces when solving the problem on Newton's law of motion is shown in Table 3. It appears that the student's ability to represent the forces was unsatisfactory. Most of the students did not represent the forces. Most of the other students represented the direction and magnitude of forces in the system but were incomplete. Only several students were able to represent the direction and magnitude of force in the system correctly and completely.

Table 3. The composition of students' ability to represent forces.

Description	Max Score	Number of Students			
		Problem No. 1	Problem No. 2	Problem No. 3	Problem No. 4
Directions and magnitudes of the forces on the system were drawn completely and correctly	20	2	2	5	4
Directions and magnitudes of the forces on the system were drawn incompletely	15	42	35	36	42
Directions and magnitudes of some forces on the system were drawn mistakenly	10	3	2	1	19
Directions and magnitudes of the forces on the system were drawn mistakenly	5	0	0	1	0
No work done	0	58	66	62	40

Most of the students correctly wrote the direction and magnitude of the force on some objects whereas the force acting on other objects was not written. Some of the direction and magnitude of the force that was often not written completely or written but incorrectly was a frictional force. Some students wrote gravity for objects in the incline, but gravity did not lead to the center of the earth. In addition, students often did not write components of forces for objects in the incline. Based on the data, it appears that most students did not write down the direction and magnitude of the force, they tended to use the mathematical formulation directly and determined the appropriate solution. For several students who answered correctly, the direction and magnitude of force were written completely and correctly. The forces in each object were correctly drawn, including the components of the forces for the objects in the incline. The components of the force in the direction of the x-axis and the y-axis were identified and drawn correctly.

Students' Ability in Determining The Type and Direction of Motion

The proportion of students in determining the type and direction of motion when solving the problems is shown in Table 4. It appears that most of the students did not write the resultant force so that they could not identify the direction of motion. Most of the other students were able to determine the resultant force but only on one component, the notation or the direction of motion. In addition, most of the students were wrong in determining the resultant of forces with notation and/or direction of motion. On the problem no. 4, there were 15 students who were able to determine the resultant of forces and write the notation and direction of motion correctly. Three objects in horizontal plane connected by a rope allowed students to easily identify the forces and their resultant. It was also relatively easier for the students to determine the direction of motion and writing symbols because there were only gravity, tension, and normal force.

Table 4. The composition of students' ability to determine the type and direction of motion.

Description	Max Score	Number of Students			
		Problem No. 1	Problem No. 2	Problem No. 3	Problem No. 4
The resultant force was found correctly with a correct notation of type and direction of motion	20	2	0	3	15
The resultant force was found correctly with a correct notation of type or direction of motion	15	19	15	18	22
The resultant force was found mistakenly with a correct notation of type and/or direction of motion	10	22	21	19	20
The resultant force was found mistakenly with an incorrect notation of type and direction of motion	5	22	3	4	10
No work done	0	40	66	61	38

Students Ability in Writing Solutions for Equations

The proportion of students in writing mathematical equations and solutions when solving the problems on Newton's law of motion is shown in Table 5. It appears that most of the students were able to correctly write the equations for unknown variables. Likewise, with the writing of solutions, most of the students

were able to solve them. Only a small number of students who answered incorrectly, they generally wrote the equation correctly, but it was difficult to finish up to get the solution. Some common mistakes were when moving variables from one to the other, and incorrectly calculating the division operation.

Table 5. The composition of students' ability to write solutions for equations.

Description	Max Score	Number of Students			
		Problem No. 1	Problem No. 2	Problem No. 3	Problem No. 4
Equations for unknown variables were written, and a correct result was obtained	5	100	88	67	97
Equations for unknown variables were written, but an incorrect result was obtained	4	3	17	38	8
Equations for all unknown variables were not written, but a correct result was obtained	2	0	0	0	0
Written equations and the result were incorrect	1	2	0	0	0
No work done	0	0	0	0	0

Students Ability in Writing the System of Units

The proportion of students in writing all of the units of physics quantities when solving the problems on Newton's law of motion is shown in Table 6. It appears that most of the students could write units for all appropriate quantities of physics. The

units of force, acceleration, and mass were written completely and correctly. Some of the other students wrote the unit correctly, but the writing of the symbol was wrong. For this group of students, some symbols that were often wrong in writing were forces symbols, especially frictional forces.

Table 6. The composition of students' ability to write the system of units.

Description	Max Score	Number of Students			
		Problem No. 1	Problem No. 2	Problem No. 3	Problem No. 4
Each term was used in the same and its own system of unit	5	70	72	97	85
Some terms were used in the same and their own system of unit	4	29	30	7	16
Terms were used in the different but their own system of unit	3	1	0	0	0
Some terms were used in the correct system of the unit but shown with incorrect symbols	2	5	3	1	4
No work done	0	0	0	0	0

The results of the study illustrated that students' ability in identifying coordinate axes, drawing free-body diagrams, representing forces, determining direction of motion based on the resultant forces, writing equations and solutions, and writing units when solving physics problems on Newton's law of motion could

be said to be unsatisfactory, especially on the aspects of identifying coordinate axes, drawing free-body diagrams, representing forces, and determining direction of motion based on the resultant forces. Based on the data in Table 1 to Table 6, it could be said that the proportion of the number of students on aspects with

unsatisfactory ability tended to be consistent. Students who were unable to identify the coordinate axes had a tendency not to be able to draw free-body diagrams. Likewise, students who were unable to identify the coordinate axes and draw free-body diagrams had a tendency not to be able to represent forces and determine the direction of motion based on the resultant of forces. Some students solved the problems by directly using mathematical formulations and calculating the appropriate solutions.

Discussion

The results of this study indicated that students' ability in identifying coordinate axes was not satisfactory. The students were not able to determine the coordinate axes, especially for objects in the incline. Students had difficulties in determining x-axis and y-axis. Students' orientation to the coordinate axes remained in vertical and horizontal coordinate system. For a dynamic system consisting of two objects connected to the pulley, one object was in the incline, and another was hanging, most students were able to determine the coordinate system for the hanging object, but the student found it difficult to determine the coordinate system of objects that were in the incline. Students preferred to determine the magnitude of the force components directly rather than determine the axes and direction of the force components because they had to do many steps. In addition to determining the coordinate axes, students also had to determine the magnitude and direction of the force components and summarize the directional force components. This result is consistent with the research of (Flores-García, Alfaro-Avena, Chávez-Pierce, Luna-González, & González-Quezada, 2010) which states that students tend to directly use mathematical formulations rather than describing forces and their components geometrically.

Determining the coordinate systems is one of the strategies to be taken when solving the problems of force and motion (Science, 2005; Serway & Jewett, 2014). Students have learned about straight-motion kinematics thus strengthening their orientation of x and y coordinates systems in the horizontal and vertical directions. They have difficulties in changing the orientation of the coordinate system for objects in the incline. Thus, teachers should instill students' understanding of the coordinate system, especially for systems or objects that are on the incline. One way, as suggested by (Mazur, 2015), is to choose a coordinate system in such a way that one of the coordinate axes is in the acceleration direction of the object.

The results of this study indicated that students' ability in drawing free-body diagrams and representing forces was unsatisfactory. Free-body diagrams are sketches of objects and arrows that represent the forces acting on objects. The forces are represented by arrows and labeled according to the direction and forces type. The representation of free-body diagrams is a standard procedure for solving the problems on Newton's law of motion (Cutnell & W, 2012; Halliday, Resnick, & Walker, 2014). In this study, students only drew representations of particular forces, especially forces in vertical or horizontal direction. If forces were not in vertical or horizontal direction, students found it difficult to represent the forces in free-body diagrams. The day-to-day experience of vertically (e.g., free falling objects) and horizontally moving objects (e.g., car motion) caused students to be easier in representing forces in vertical or horizontal directions yet caused them difficulties in representing forces in other directions.

Students had difficulties in drawing free-body diagrams. The results of this study are similar to (Lee, 2017) and he proposes five steps in describing free-body diagrams, including a) sketching the

system of objects, b) selecting objects and performing isolation, c) defining forces and giving special marks, d) identifying forces and giving labels, and e) drawing the forces. In addition, (Heckler, 2010) suggests that teachers should implement collaborative problem-solving learning. Collaborative learning helps students learn to draw free-body diagrams and learn to solve problems based on correct procedures. By collaborative learning, students can learn to solve tasks partially and discuss to solve problems in an integrated manner.

Students' ability to determine the direction of motion of objects was also unsatisfactory. Students had difficulties in representing the direction of the force acting on the object. Students also found it difficult to represent vectors and operations mathematically to produce resultant vectors. Students rarely gave qualitative explanations of vectors and the relationship between a vector and its component vectors. Students had difficulties in determining the components of the force causing the students difficulty in determining the resultant of forces. The majority of the students had no functional understanding of Newton's second law as a relationship between vectors. The results of this study are consistent with the results of previous studies which suggest that most students have difficulty regarding vectors (Sari, Suyanto, & Suana, 2017) and their application in solving the problem of Newton's law of motion (Flores et al., 2004). To overcome such difficulties, (Flores et al., 2004) suggest that the content and sequence, of course, topics should be adapted to the target, i.e., the development of students' skills in understanding vectors and their application in mechanical systems.

The results showed that the students' ability in determining the solution of the problems on Newton's law of motion belongs to the satisfactory category. Students' ability in writing the system of

the unit for each quantity of physics showed similar results. Students tended to use mathematical formulas or shortcuts, commonly called *smart solutions*. Although they obtained a correct solution, it did not necessarily describe the ability of students in solving problems. Students who only determine the solution without the correct problem-solving procedures cannot be categorized as an expert. Rosengrant suggests that expert students in problem-solving have the ability to categorize problems in several types according to the physics principles used to solve problems, have a lot of procedural knowledge, and have a lot of interrelated and shared knowledge (Rosengrant et al., 2009). Students in expert categories have a lot of knowledge and know how to use their knowledge, begin with making good analysis and plan before solving the problem. The analysis was done by giving qualitative descriptions based on the principles of physics correctly without too many uses of mathematical calculations.

The results of this study indicated that the ability of students in solving problems based on procedures and physics rules was unsatisfactory. Thus, students must learn to use procedures and rules in accordance with the principles of physics. Determining the coordinate system, free-body diagram, forces representation, direction of movement, solution, and unit of physics quantity are important components that need to be given to students in order to possess the problem-solving ability. The use of multiple representations can assist the students in learning and building concepts and solve problems (Irwandani, 2014). Collaborative learning becomes an alternative strategy. In collaborative learning, students are taught to be responsible for the tasks assigned to each individual, before finally being integrated with solutions produced by other students. In collaborative work, students with better ability can help others who need learning assistance. Students

also need to be taught procedural thinking because the completion of physics problems is basically a sequential procedure until a solution is obtained.

CONCLUSIONS AND SUGGESTIONS

The students' ability to solve the physics problems on Newton's law of motion was unsatisfactory. Although most of the students were able to provide solutions and write the units well, the ability to identify the coordinate axes, draw free-body diagrams, represent forces, and determine the direction of motion based on the resultant of forces was not satisfactory. It takes a lot of effort to help students to learn, especially by teachers to keep improving the learning process by implementing innovative learning strategies that stimulate students to be more active. Collaborative learning and procedural thinking exercises become alternative learning that can be applied so that the students are able to solve physics problems. Moreover, teachers can teach the use of various representations in solving physics problems so that the students have a good mastery of Newton's law so that it can be used to study the next material of physics.

REFERENCES

- Arends, R. I. (2012). *Learning to Teach 9th Edition* (9th ed.). New York: McGraw-Hill Companies, Inc.
- Arikunto, S. (2003). *Prosedur Penelitian, Suatu Praktek*. Jakarta: Bina Aksara.
- Bogard, T., Liu, M., & Chiang, Y. V. (2013). Thresholds of Knowledge Development in Complex Problem Solving: A Multiple-Case Study of Advanced Learners' Cognitive Processes. *Educational Technology Research and Development*, 61(3), 465–503.
- Carson, R., & Rowlands, S. (2005). Mechanics As the Logical Point of Entry for the Enculturation Into Scientific Thinking. *Science & Education*, 14(3), 473–493.
- Chang, Y. C. (2010). Does Problem-Solving = Prior Knowledge + Reasoning Skills In Earth Science? An Exploratory Study. *Research in Science Education*, 40(2), 103–116.
- Coelho, R. L. (2010). On the Concept of Force: How Understanding Its History Can Improve Physics Teaching. *Science & Education*, 19(1), 91–113.
- Cutnell, J. D., & W, J. K. (2012). *Physics, 9th Edition*. (9, Ed.). New Jersey: John Wiley & Sons, Inc.
- Duschl, R., Schweingruber, H., & Shouse, A. (2007). *Taking Science to School: Learning and Teaching Science in Grades K-8*. Washington, DC: National Academies Press.
- Fisher, K. (1999). Exercises in Drawing and Utilizing Free-Body Diagrams. *The Physics Teacher*, 37(7), 434–435.
- Flores-García, S., Alfaro-Avena, L. L., Chávez-Pierce, J. E., Luna-González, J., & González-Quezada, M. D. (2010). Students' Difficulties with Tension in Massless Strings. *American Journal of Physics*, 78(12), 1412.
- Flores, S., Kanim, S. E., & Kautz, C. H. (2004). Student Use of Vectors in Introductory Mechanics. *American Journal of Physics*, 72(4), 460–468.
- Gaigher, E., Rogan, J. M., & Braun, M. W. H. (2007). Exploring the Development of Conceptual Understanding Through Structured Problem-Solving in Physics. *International Journal of Science Education*, 29(9), 1098–1110.
- Gok, T. (2015). An Investigation of Students' Performance After Peer Instruction with Stepwise Problem-Solving Strategies. *International Journal of Science and Mathematics Education*, 13(3), 561–582.
- Halliday, D., Resnick, R., & Walker, J. (2014). *Fundamentals of Physics*,

- 10th Edition (9th ed.). New Jersey: John Wiley & Sons, Inc.
- Heckler, A. F. (2010). Some Consequences of Prompting Novice Physics Students to Construct Force Diagrams. *International Journal of Science Education*, 32(14), 1829–1851.
- Heller, P., Keith, R., & Anderson, S. (1992). Teaching Problem Solving Through Cooperative Grouping. Part 1: Group Versus Individual Problem-Solving. *American Journal of Physics*, 60, 627–636.
- Herdiansyah, H. (2010). *Metodologi Penelitian Kualitatif untuk Ilmu-Ilmu Sosial*. Jakarta: Salemba Humanika.
- Hong, J. C., Chen, M. Y., Wong, A., Hsu, T. F., & Peng, C. C. (2012). Developing Physics Concepts Through Hands-on Problem Solving: A Perspective on A Technological Project Design. *International Journal of Technology and Design Education*, 22(4), 473–487.
- Huffman, D. (1997). Effect of Explicit Problem-Solving Instruction on High School Students' Problem-Solving Performance and Conceptual Understanding of Physics. *Journal of Research in Science Teaching*, 34(6), 551–570.
- Irwandani. (2014). Multirepresentasi sebagai Alternatif Pembelajaran dalam Fisika. *Jurnal Ilmiah Pendidikan Fisika Al-BiRuNi*, 3(1), 39–48.
- Jonassen, D. H. (2000). Toward a Design Theory of Problem-Solving. *Educational Technology Research and Development*, 48(4), 63–85.
- Jonassen, D. H., & Tessmer, M. (1996). An Outcomes-Based Taxonomy for the Design, Evaluation, and Research of Instructional Systems. *Training Research Journal*, 2, 96–97.
- Kay, K. (2010). *21st-Century Skills: Why They Matter, What They are, and How We Get There. Foreword in: 21st Century Skills: Rethinking How Students Learn*. Bloomington: IN Learning Tree.
- Kelly, P. (2005). *Using Thinking Skills in the Primary Classroom*. London: Paul Chapman Publishing.
- Kemendikbud. (2016). *Permendikbud No. 21 Tahun 2016 tentang Standar Isi Kurikulum 2013*. Jakarta.
- Kim, M. K. (2012). Theoretically Grounded Guidelines for Assessing Learning Progress: Cognitive Changes in Ill-Structured Complex Problem-Solving Contexts. *Educational Technology Research and Development*, 60(4), 601–622.
- Kocakulah, M. S. (2010). Development and Application of a Rubric for Evaluating Students' Performance on Newton's Laws of Motion. *Journal of Science Education and Technology*, 19(2), 146–164.
- Lee, A. (2017). Helping Students Draw Correct Free-Body Diagrams. *The Physics Teacher*, 55, 485–487.
- Lovett, M. C. (2002). *Stevens' Handbook of Experimental Psychology: Vol. 2. Memory and Cognitive Processes*. New York: Wiley.
- Malone, K. L. (2008). Correlations Among Knowledge Structures, Force Concept inventory, and Problem-Solving Behaviors. *Physical Review Special Topics-Physics Education Research*, 4, 1–15.
- Mason, A., & Singh, C. (2010). Helping Students Learn Effective Problem-Solving Strategies by Reflecting with Peers. *American Journal of Physics*, 78(7), 748–754.
- Matthews, M. R. (2009). Teaching the Philosophical and Worldviews Components of Science. *Science & Education*, 18(6), 697–728.
- Mazur, E. (2015). *Principles & Practice of Physics*. New Jersey: Pearson Education, Inc.
- Moreno, R. (2010). *Educational Psychology*. New Jersey: John Wiley

- & Sons, Inc.
- Narjaikaew, P. (2013). Alternative Conceptions of Primary School Teacher of Science About Force and Motion. *Procedia-Social and Behavioral Sciences*, 88, 250–157.
- Robertson, S. I. (2016). *Problem Solving: Perspectives from Cognition and Neuroscience*. Philadelphia, PA: Psychology Press.
- Rosengrant, D., Van Heuvelen, A., & Etkina, E. (2009). Do Students Use and Understand Free-Body Diagrams? *Physical Review Special Topics-Physics Education Research*, 5.
- Rowlands, S., Graham, T., Berry, J., & McWilliam, P. (2007). Conceptual Changes Through the Lens of Newtonian Mechanics. *Science & Education*, 16(1), 21–42.
- Sabella, M. S., & Redish, E. S. (2007). Knowledge Organization and Activation in Physics Problem-Solving. *American Journal of Physics*, 75(11), 1017–1029.
- Santrock, J. W. (2011). *Educational Psychology, 5th Edition* (5th ed.). New York: McGraw-Hill.
- Sari, W. P., Suyanto, E., & Suana, W. (2017). Analisis Pemahaman Konsep Vektor Pada Siswa Sekolah Menengah Atas. *Jurnal Ilmiah Pendidikan Fisika Al-BiRuNi*, 6(2), 159–168.
<https://doi.org/10.24042/jipfalbiruni.v6i2.1743>
- Science, G. (2005). *Physics: Principles and Problems*. Columbus, OH: Glencoe/McGraw-Hill.
- Semiawan, R. C. (2010). *Metode Penelitian Kualitatif*. Jakarta: PT. GramediaWidiasarana Indonesia.
- Serway, R. A., & Beichner, R. J. (2000). *Physics for Scientists and Engineers*. Orlando: Saunders College Publishing.
- Serway, R. A., & Jewett, J. W. (2014). *Physics for Scientists and Engineers with Modern Physics, 9th Edition*. Boston: Brooks/Cole.
- Slavin, R. E. (2018). *Educational Psychology: Theory and Practice*. New York: Pearson.
- Tasar, M. (2010). What Part of the Concept of Acceleration is Difficult to understand: the mathematics, the physics, or both? *ZDM*, 36(4), 222–223.
- Van den Berg, E., & Huis, V. (1998). Drawing forces, The Physics Teacher. *The Physics Teacher*, 36(4), 222–223.
- Wendel, P. (2011). Adding Value to Force Diagrams: Representing Relative Force Magnitudes. *The Physics Teacher*, 49(5), 308–311.
- Yilmaz, I., & Yalcin, N. (2012). The Relationship of Procedural and Declarative Knowledge of Science Teacher Candidates in Newton's Laws of Motion on understanding. *American International Journal of Contemporary Research*, 2(3), 50–56.
- Young, H. D., Freedman, R. A., & Ford, A. L. (2016). *Sears and Zemansky's University Physics: with Modern Physics* (14th ed.). San Francisco, CA: Pearson Education, Inc.

DEVELOPING STUDENT WORKSHEET OF TEMPERATURE AND HEAT BASED ON SCIENTIFIC PROCESS SKILL

Fharia Fhadhila*¹, Candra Ertikanto², Undang Rosidin³

^{1,2,3} Physics Education Department, Postgraduate Program, Universitas Lampung, Indonesia

*Correspondence address: fhariaf@yahoo.com

Accepted: December 12th, 2017. Approved: March 28th, 2018. Published: April 29th, 2018

Abstract: This research aims to develop a product in the form of Student Worksheet of temperature and heat based on Scientific Process Skills. The study was conducted within five stages: analysis, design, development, implementation, and evaluation. The results of the research showed that Student Worksheet's construct validity value of 80.30% and 70.96% of content validity. Student Worksheet has a questionnaire value of easiness of 3, 29, attractiveness of 3.32 and usefulness of 3.19. Student Worksheet effectively increases the average of the students' learning outcomes both in the cognitive domain of 80.00, affective domain of 81.30% and psychomotor domain of 80.81. Based on the results of the research, it can be said that Student Worksheet achieved the goal of characteristics development i.e., possesses content validity and construct validity in the good category, user feedback questionnaire with the result of very easy to use, highly attractive and helpful, and the effectiveness of increasing the average students' learning outcomes in the very high category. For future studies, the researchers suggest that the Science Process Skill-based worksheets are not only applied to the temperature and heat material but can be applied to other branches of science.

© 2018 Physics Education, UIN Raden Intan, Lampung, Indonesia.

Keywords: Scientific process skills, student worksheet, temperature and heat

INTRODUCTION

Education is a very important necessity of life for humans; because the human education can be utilized to improve some potential through the learning process so that they can meet their needs (Diani, 2016). Management of education in the modern era is increasingly dependent on the qualification of the educators to use the resources that were available to overcome problems that are faced by learners, as well as to prepare lessons to foster the way of the learners' creative thinking with science and technology development orientation (Khairunisa, 2016).

The process of science is the way in which scientists develop products of sciences, therefore, to be able to do a qualify science process, skills of science process are required, while product knowledge to produce something from the process of science done by scientists

involving Scientific Process Skills (Supriyatman & Sukarno, 2014).

The use of scientific approach in the invention process is able to encourage the skills of students, one of them is Scientific Process Skills (Siahaan & Suyana, 2010). (Nuraini, Karyanto, & Sudaris, 2014), argues that Scientific Process Skills is also important in terms of teaching the students to proceed and work systematically to obtain their expectation.

One form of printed teaching materials that can be used in the learning process is the Student Worksheet. Student Worksheet is sheets contain tasks that must be done by learners. The use of student worksheet in learning is one of the efforts to be made to familiarize the behavior of scientists on the learners. Based on observations from several worksheets that circulate in the field contains a summary of the material and exercises, yet they do not train the

students the process of investigation to find the concept.

Based on the results of the literature study and need analysis of the students in SMAN 1 Banjit which is one of the high schools in Way Kanan that have implemented the curriculum of 2013. The questionnaire results and interview in the field found that the students' low score of physics, the learning process only used textbooks and did not use materials such as worksheets, the study was only focused on teachers, and the laboratory activities are rarely carried out (Fharia & Ertikanto, 2015).

Based on the explanation, Physics physics has not been supported by facilities among other books, worksheets, and instructional media. Besides as the media of learning that can help the students, Student Worksheet can also facilitate the learners' communication with the teacher with an orientation of Scientific Process Skills. One of the materials in physics is temperature and heat. it is one of the concepts of physics in accordance with the characteristics of the Scientific Process Skills approach. On the concept of temperature and heat, the students are required to observe changes in temperature on the thermometer, make hypotheses regarding heat transfer, interpret data between temperature and time which causes the change of forms, communicate the graph of form changes. In addition, the concept of temperature and heat phenomena often encountered in everyday life.

Based on this, the researchers intend to develop a Student Worksheet of the temperature and heat material based on the Scientific Process Skills approach. The aim of this research is to develop a product of Student Worksheet on the temperature and heat material based on Scientific Process Skills.

THEORETICAL FRAMEWORK

One of the abilities that must be owned by teachers or educators is to be able to carry out their professional tasks by understanding how students learn and how to organize the learning process. Thus the teachers or educators will be able to develop and shape the character of the learners and to understand how students are undergoing their learning activities. Reber (Sugihartono, 2007) defines learning in two senses. First, learning as a process of acquiring knowledge, and second to learn as an ongoing transformation of the creative ability as a result of enforced exercises.

Learning is the teachers' programmed activities in the instructional frame, to create active learning, which emphasizes the provision of learning resources Dimiyati and Mudjiono (Sagala, 2011). In general, learning is a conscious effort made by an educator for the learners by providing appropriate instruction in accordance with other learning resources to achieve the desired goal (Trianto, 2007).

One of the factors of success in the learning process is the existence of teaching materials such as worksheets. One form of printed teaching materials that can be used in the learning process is the Student Worksheet (Assalma, Rahayu, & Sri, 2013). The student worksheet is the teaching materials that have been packaged in a way that the students are expected to learn the teaching material independently (Damayanti, Ngazizah, & K, 2012). According to the study by (Purnamawati, Ertikanto, & Suyatna, 2017), the use of inquiry-based Student Worksheet is effective to regenerate all higher-order thinking skills of the students.

Learning through the process skills approach enables students to cultivate scientific attitude to develop fundamental skills so that in the learning process, the students can understand the learned

concepts, thus learning outcomes that include knowledge, skills, and attitudes as demands of the curriculum competence will be achieved (Subagyo, Wiyanto, & Marwoto, 2009).

Scientific Process Skills are skills gained from exercising mental abilities, physical, social fundamentally as the motor toward the more advanced capacity (Rustaman, 2007). Also mentions the Scientific Process Skills are the scientific skills of the students when doing science-based activities to acquire concept and understanding (Budisetyawan, 2012).

Process Skills consists of a number of skills that cannot be separated from one another, but there is a special emphasis in each of these skills. Below in the table 1 are the sub-skills with the indicator process according to (Rustaman, 2007), namely:

Table 1 Scientific Process Skills and Indicators of the Scientific Process Skills

No	Scientific Process Skills	Indicators of the Scientific Process Skills
1	Observing	<ul style="list-style-type: none"> Using as many senses as possible Collecting or using any of the relevant facts
2	Grouping / Classification	<ul style="list-style-type: none"> Taking notes of any observations separately Taking notes of the differences and similarities Contrasting traits comparing Finding basic grouping or classification Connecting the observed results
3	interpreting	<ul style="list-style-type: none"> Connecting the observed results Finding patterns in a series of observations Concluding
4	predicting	<ul style="list-style-type: none"> Using patterns of observations Suggesting what might happen on the circumstances that have not been observed
5	Asking	<ul style="list-style-type: none"> Asking what, how and

	question	why <ul style="list-style-type: none"> Asking for clarification Asking the hypothesis backgrounds
6	hypothesizing	<ul style="list-style-type: none"> Knowing that there is more than one possible explanation for a phenomena Be aware that some explanation needs to be verified by obtaining more evidence or conducting problem-solving
7	Research Planning / Experiments	<ul style="list-style-type: none"> Determining the tool/material/sources to be used Defining variables or deciding factors Determining what will be measured, observed and recorded Determining what will be implemented in the form of work steps
8	Using the Tools/ Materials	<ul style="list-style-type: none"> Using tools/materials Knowing the reason for why using the tool/material Knowing how to use the tool/material applying Concepts Using the concepts learned in new situations Using the concept of the new experience to explain what was going on
9	Predicting	<ul style="list-style-type: none"> Using patterns observations Suggests what might happen on the circumstances that have not been observed
10	Asking question	<ul style="list-style-type: none"> Asking what, how and why Asking for clarification Asking the hypothesis backgrounds

METHOD

This study used ADDIE development model (Singh, 2009). This model consists of five main phases or stages, namely 1) Analysis, 2) Design, 3) Development, 4) Implementation, 5) Evaluation.

The design of product try-out through *pretest-posttest control group design*, this design was used to compare the progress of students after learning between experimental class control class. The research design is shown in the table 2 below (Sugiyono, 2013: 116)

Table 2 Nonequivalent pre-post control group design

Experiment	O1	X1	O2
Control	O3	X2	O4

Information:

- X1 The treatments were learning through the use the worksheets that have been developed
- X2 Treatment was learning through a conventional worksheet
- O1 *pretest* to the experimental class
- O2 *Posttest* to the experimental class
- O3 *pretest* to the control class graders
- O4 *Posttest* to the control; class

RESULTS AND DISCUSSION

Analysis

This research and development aim to develop teaching materials in the form of material Student Worksheet of temperature and heat material based on the Scientific Process Skills. At this stage, it is important to analyze the needs toward the developed product by analyzing the preliminary research result that had been done to two physics teacher and 33 students at the high school level through questionnaire and interviews.

Researchers conducted a preliminary study and analyzed information from the questionnaire related to student worksheet development and the implementation of Scientific Process Skills approach. The researcher conducted curriculum analysis to determine the appropriate product in line with the demands of the curriculum. Curriculum analysis would produce themes that were relevant to Core Competence and Basic Competence.

Design

Product developed is in the form of students worksheets. The student worksheet is one of the widely used teaching materials. However, worksheets that correspond to Scientific Process Skills have not been used by teachers yet. Therefore, the researchers decided to choose Student Worksheet as teaching materials to be developed. Researchers developed a worksheet that serves as a practical guide and a guide in observation (Praswoto, 2014).

Student Worksheet formats are developed in accordance with the steps of Scientific Process Skills. The learning through Scientific Process Skills was selected so that it could be in line with the purpose of development of the teaching materials in the form of worksheets. The draft of the developed worksheet includes the title "Students Worksheet through Science Process Skill Approach (Temperature and Heat)". In accordance with the title, the basic competencies that students must achieve are Basic Competence 4.8 namely, Planning and implementing experiments to investigate the thermal characteristics of a material, especially the capacity, and thermal conductivity. Learning objectives to be achieved by the students were written in the early part of the activities of the worksheet. The achieved objectives were adjusted with the activities. Procedures or students' learning activities in the use of worksheets were developed in accordance with the Scientific Process Skills approach.

Development

The third step is the interpretation of the planning. In this step, all the things that are planned in the development of the worksheet were conceived and designed so that a draft product was produced. In this step, the developed worksheet had been produced as the results of the development in accordance with the

planning that has been done. The following description of the draft can be seen in Table 3.

Table 3 Description of the draft of the product

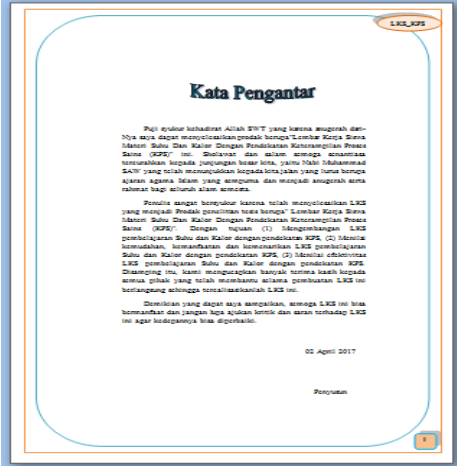
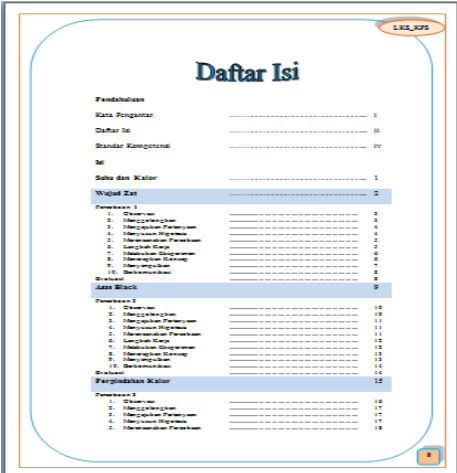
No.	Student Worksheet Part	Image	Description
1	cover		<p>The cover displayed the titles relevant to the objective of the worksheet, material contained in the worksheets, some images related to the material and the developers' image</p>
2	Preface		<p>The preface is in the form of gratitude and thanks to the authors toward several parties that have supported the completion of the worksheet</p>
3	Table of Contents		<p>This section showed the core competence and basic competence that should be met by the students after learning through temperature and heat material worksheet through Scientific Process Skills approach</p>

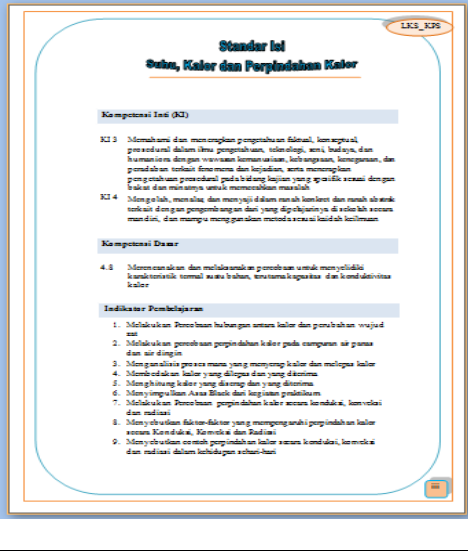
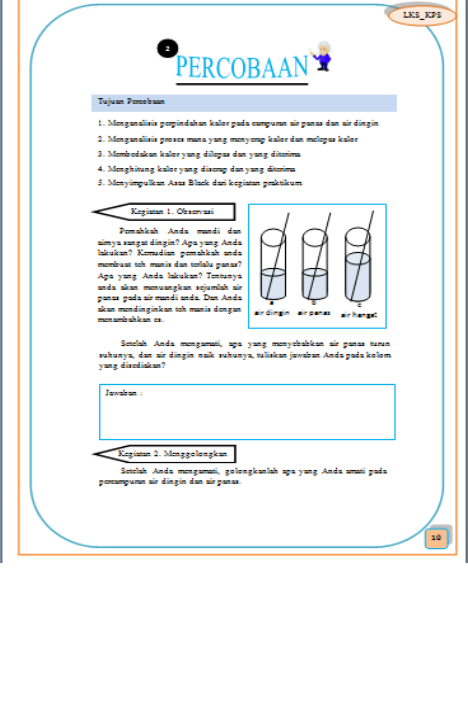
<p>4 Core Competence and Basic Competence</p>		<p>This section showed the core competence and basic competence that should be met by the students after learning through temperature and heat material worksheet through Scientific Process Skills approach</p>
<p>5 The activity of the Worksheet</p>		<p>There are three experiments presented in the developed worksheet. The title of the experiment (1). Principle Black, (2). Substances and (3). Heat transfer. The worksheet was developed based on the indicators of Science Process Skill Approach:</p> <ol style="list-style-type: none"> (1) Observing (2) Classifying (3) Asking question (4) Formulating hypothesis (5) Planning experiment (6) Determining the pace of work (7) Conducting experiments (8) Applying the concept (9) Summing up and, (10) communicating <p>One example of activities that are included in the worksheet.</p>

Implementation

At this stage, validation or assessment to determine the propriety of the worksheets based on the construct and Content validity was conducted. The Worksheet’s feasibility validation was done by two professors and one expert practitioner. Results of content validity and construct validity can be seen in Figure 1.

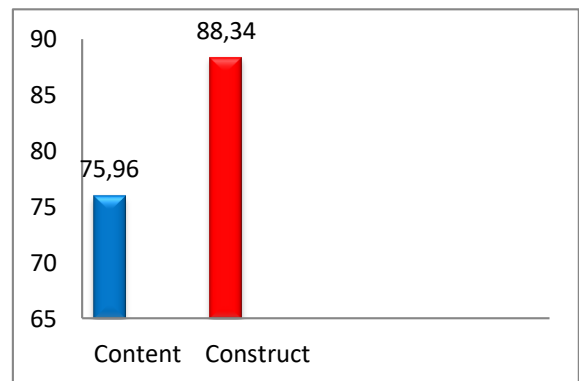

Figure 1 Graph of Content and Construct Validity Assessment.

Based on the results of the expert, the value of the construct validity was 88.37% while the average value was 70.67 which fall into the good category. The value obtained through content validation was 75.96% while the average value of content validity was at 39.5 which fall into the good category. It can be concluded that the developed worksheet has been appropriate to be implemented as a teaching material.

Evaluation

This field testing aimed to evaluate the effectiveness and determine the responses of teachers and students toward the developed worksheet. The field testing of the worksheet was given to 34 students of class X Science 2 of SMA Negeri 1 Banjit. In this case, students were given the treatment in the form of learning materials using the Temperature and Heat worksheet developed by the researchers. Before implementing the worksheets, the students did a pretest to determine their score in Science Process Skill before implementing the worksheet. The implementation of Student Worksheet based on Scientific Process Skills Approach began with the stages of the indicators and explanations of then learning steps contained in the worksheet.

The statistical test used was Paired Sample t-test to determine whether there was an increase in the learning outcomes of students in the experimental class after implementing the developed worksheet and the test was also used to determine whether there was difference of the score of the students' Science Process Skill between the experimental class and the control class.

The analysis showed the Sig. (2 tailed) in Paired Sample T-Test was 0,000. Thus, Ho was rejected. This means that there was a significant improvement in the experimental class proved by higher score compared to the score of the students in the control class. Tests were

carried out with the data analysis of Paired Samples t-test. Based on the analysis, it was shown that the Sig. (2 tailed) was $0.000 < \alpha (0.005)$. Thus, it can be concluded that Ho was rejected, or the average score of students' posttest after learning using worksheet through Scientific Process Skills approach was higher than the pretest.

Based on the statistical analysis, the use of worksheet of temperature and heat material through Scientific Process Skills Approach toward the students of the tenth grade of SMA Negeri 1 Banjit was effective in improving the students' learning outcome.

After the suitability and feasibility of the product were known, then the product's field testing was conducted to the students to determine its effectiveness and to find out the responses of the students toward the product, the results of questionnaires showed that the easiness, attractiveness, and usefulness could be seen in Figure 2.

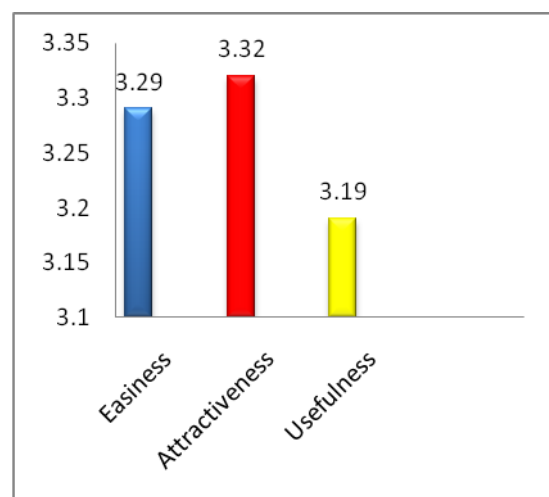

Figure 2 Recapitulation of questionnaire responses of the easiness, attractiveness, and usefulness

The results of student responses to the instructional materials of the Student Worksheet of Temperature and Heat material through Scientific Process Skills Approach were taken through questionnaires given to the teachers and

students. Based on the results of the questionnaires, the developed worksheet was in the very easy, very attractive and very helpful category. The results of this research were in agreement with research (Tarmizi, 2010), students agreed that the application of Scientific Process Skills approach made the students understand the material easily. How the teacher presented the lessons with the application of Scientific Process Skills Approach was interesting. From the research and reference, it can be concluded that based the use of Student Worksheet through Scientific Process Skills approach was very easy, very interesting and very useful in the process of learning and teaching.

The results of students' score based on the average score of pre-test and post-test and the value of N-gain showed that there was a significant difference. This result was found after being given different treatment; the experimental class used worksheet of temperature and heat through Scientific Process Skills Approach while the control class used the conventional worksheet. The calculation result of the value of N-gain for both classes can be seen in Table 4.

Table 4 Results of N-gain learning outcomes

Class	Average - Average N- gain	categories
Control	0.40	moderate
Experiment	0.71	High

The results of the calculation, the average value of the N-gain in the experimental class was 0.71 which is in the category of Moderate and the average value of the N-gain of the control class was 0.40 which is in the high category. To determine the difference in value between the experimental class and the control class, a hypothetical test was employed.

The result of the hypothetical test calculation showed that there are differences in the score of the students in

the experimental class compared to the students in the control class. The second effectiveness test was the difference score of pretest and posttest of the experimental class.

Based on the second effectiveness test, it can be concluded that the average of posttest score of the students who learned using worksheet of temperature and heat through Scientific Process Skills Approach was higher than their pretest score. Results from both hypothetical tests can be concluded, the use of worksheet of temperature and heat through Scientific Process Skills Approach could increase the result of cognitive learning where the students usually just act as listeners or just observe the teacher explanation of the subject, the process of learning through the use of worksheet of temperature and heat through Scientific Process Skills Approach, the students could carry out the learning activities with indicators of Scientific Process Skills Learning that have already contained in the worksheet.

In the process of learning using the worksheets through Scientific Process Skills approach students can be included in the process of teaching and learning as if the students are conducting scientific activities, namely observing, classifying, posing questions, drawing up hypotheses, planning experiments, determining the procedures, experimenting, applying the concepts, concluding and communicating.

Affective assessment result obtained from observation sheet for the experimental and control classes. The average score of the two classes of the assessment can be seen in Table 5.

Table 5 Summary of Affective assessment

Class	Average	categories
Control	59.85	Low
Experiment	81.30	Very High

Based on the average score of attitude assessment, it can be concluded that the experimental class attitude was higher than the control class. This was

because the experimental class used worksheet of temperature and heat materials with the Science Process approach can train students' scientific attitude by showing the admiration of the greatness of God the Almighty, by showing gratitude and expressing admiration to the greatness of God the Almighty, doing the activities in the worksheet, taking care of the tools and materials well, not damaging tools and materials, able to provide ideas in solving problems. Being able to design issues according to theory and appreciate friends' opinions, accepting friends' opinions, and thinking broadly.

The results of psychomotor or skill assessments were obtained using psychomotor observation sheets. The results of the skills assessment for the experimental and control classes. The average result of skill assessment of the two classes can be seen in Table 6.

Table 6 Result of psychomotoric assessment

Class	Average	categories
Control	57.32	Low
Experiment	80.81	Very High

Based on the result of the average attitude assessment, it can be concluded that the experimental class had a higher mean score than the control class. This is because of the experimental class use worksheet of temperature and heat materials through Scientific Process Skills approach. It can train skills such as designing experimental tools and materials, identifying problems, illustrating the problem, and summarizing the results of experiments. The result of worksheet development of temperature and heat materials with the Scientific Process Skills approach in terms of the effective, psychomotor, and cognitive domains can be seen in Figure 3.

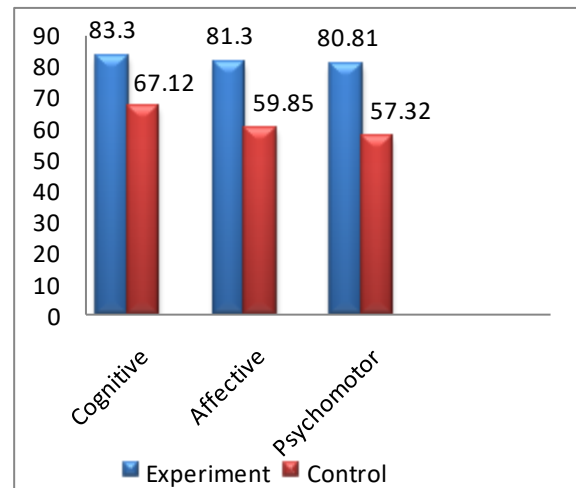

Figure 3 Recapitulations of the score of cognitive, affective and psychomotor

Based on the result of the research of the three domains, it can be concluded that the average score of the experimental class was higher than the control class. So the use of worksheet of temperature and heat material through Scientific Process Skills Approach could increase cognitive, affective and psychomotor. (Nisa & Suliyansah, 2014) state that the cognitive aspects determine the students' cognitive learning outcomes in the experimental class was better than the control class. In the experimental class, it was also obtained the score of science process skill that the science process skill in students is good and the skills that need to be taught and trained more were science process skill in making hypothesis, drawing a conclusion, experimenting, and analyzing the data.

Scientific process skills and its influence on students' learning outcomes emphasizes Scientific process skills in one science lesson means giving students the opportunity to solve their own problems that become the topic of learning by doing the activities in the worksheet based on the Scientific process skills indicators. The results of the Scientific process skills assessment of the experimental class and control class can be seen in Figure 4.

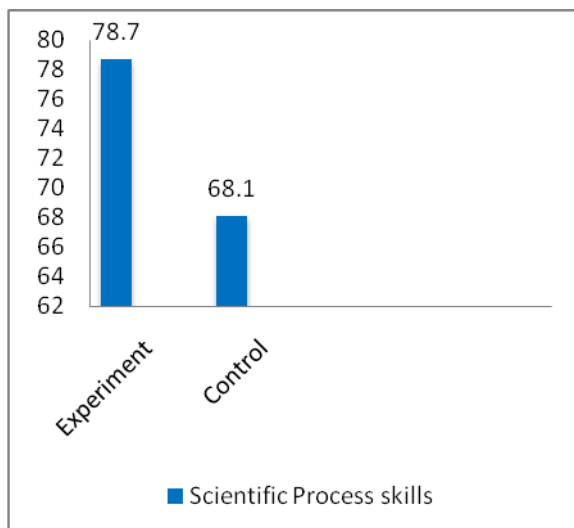

Figure 4 Assessment of Scientific Process skills

Based on the result, the experimental class was higher than the control class, this was because in the experimental class the students are trained independently to conduct experiments with the stages of Scientific Process Skills Approach, where students perform activities of observing, classifying, asking questions, making hypotheses, planning experiments, determining work procedure, experimenting, applying concepts, concluding and communicating.

Based on the (Anita, Jalmo, & Yolida, 2015) research results, the result of the experiments was seen on average N-gain of Scientific Process Skills Approach of the experimental class students were higher than the control class. The increase in Scientific Process Skills Approach can also be seen in the analysis of students' responses toward the worksheet based on the increase of each indicator. According to (Khayota, Sitti, & Sonnsusap, 2015) Scientific Process Skills Approach is required by students when conducting a scientific inquiry or during the learning process. Thus, it can be concluded that the Scientific Process Skills are very important in science learning.

Based on the analysis of experimental class through worksheet of temperature and heat materials based on Scientific

Process Skills Approach was good. It can be seen from the average of experiment class percentage which is 78,70%.

CONCLUSIONS

Based on the results of the research and discussion, it is concluded that the developed worksheet construct validity value of 80.30% and content validity value of 70.96% that fall within the good category. Student Worksheet's questionnaire gained 3.29 for easiness, 3.32 for attractiveness and 3.19 for usefulness which is in the very easy category, very interesting and useful. The worksheet was effective in increasing the average of student learning outcomes in the cognitive domain of 80.00, affective of 81.30 and psychomotor of 80.81 which are in the very high category.

SUGGESTIONS

Based on the result of the research, the researchers suggest that Student Worksheet based on scientific Process Skills should not be only applied to temperature and heat material, but can be applied with other branches of science. Teachers are expected to intensify their role as facilitators when learning in the classroom so that the allocation of available time can be utilized well.

REFERENCES

- Anita, I., Jalmo, T., & Yolida, B. (2015). Pengembangan LKS Berbasis Keterampilan Proses Sains (KPS) Untuk Meningkatkan KPS Siswa. *Pendidikan Biologi*.
- Assalma, N. E., Rahayu, E. S., & Sri, R. (2013). Pengembangan Lembar Kerja Siswa Dengan Pendekatan Pembelajaran Berbasis Proyek (PBP) Dan Berwawasan Salingtemas. *Unnes Journal of Biology Education*, 2(1), 1–9.
- Budisetyawan, S. (2012). Pengembangan LKS IPA Terpadu Berbasis Inkuiri

- Terbimbing pada Tema Sistem Kehidupan dalam Tumbuhan Kelas VIII di SMPN 2 Playen. *Jurnal IPA FMIPA UNY*, 1(4), 1–6.
- Damayanti, D. S., Ngazizah, N., & K, E. S. (2012). Pengembangan Lembar Kerja Siswa (LKS) Dengan Pendekatan Inkuiri Terbimbing. *Jurnal Progam Studi Pendidikan Fisika Universitas Muhammadiyah Purworejo*, 3(1), 1–5.
- Diani, R. (2016). Pengaruh Pendekatan Saintifik Berbantuan LKS Terhadap Hasil Belajar Fisika Peserta Didik Kelas XI SMA Perintis 1 Bandar Lampung. *Jurnal Ilmiah Pendidikan Fisika Al-BiRuNi*, 05(1), 83–93.
- Fharia, F., & Ertikanto, C. (2015). Analisis Kebutuhan Pembelajaran Suhu dan Kalor dengan Pendekatan Keterampilan Proses Sains. *Seminar Nasional Pendidikan MIPA Fakultas Keguruan dan Ilmu Pendidikan. Bandar Lampung: Universitas Lampung.*
- Khairunisa. (2016). Analisis Keterampilan proses Sains Fisika di Kabupaten Jeneponto. *Jurnal Pendidikan Fisika Universitas Muhammadiyah Makassar*, 5(3), 1–10.
- Khayota, J., Sitti, S., & Sonnsusap, K. (2015). The Curriculum Development for Science Teacher's Training: The Action Lesson Focusing on Science Proses Skills. *Education Research Dan Reviews*, 10(23).
- Nisa, C. N., & Suliyansah. (2014). Pengaruh Penerapan Pembelajaran Penemuan Terbimbing Dengan Mengintegrasikan Keterampilan Proses Sains Terhadap Hasil Belajar Siswa SMP Negeri 1 Kamal. *Jurnal Inovasi Pendidikan Fisika (JIPF)*, 3(1), 1–5.
- Nuraini, N., Karyanto, P., & Sudaris, S. (2014). *Pengembangan Modul Berbasis POE (Predict, Observe, and Explain)*. Universitas Sebelas Maret.
- Praswoto, A. (2014). *Pengembangan Bahan Ajar Tematik*. Yogyakarta: Kencana Media Group.
- Purnamawati, D., Ertikanto, C., & Suyatna, A. (2017). Keefektifan Lembar Kerja Siswa Berbasis Inkuiri Untuk Menumbuhkan Keterampilan Berpikir Tingkat Tinggi. *Jurnal Ilmiah Pendidikan Fisika Al-BiRuNi*, 6(2), 209–219.
- Rustaman. (2007). *Keterampilan Proses Sains*. Bandung: SPS UPI.
- Sagala, S. (2011). *Konsep dan Makna Pembelajaran*. Bandung: Alfabeta.
- Siahaan, P., & Suyana, I. (2010). *Hakekat Sains dan Pembelajarannya*. Bandung.
- Singh, O. B. (2009). *Development and Validation of a Web-Based Module to Teach Metacognitive Learning Strategies to Students in Higher Education. A dissertation submitted in partial fulfillment of the requirements for the degree of Doctor of Philosophy Department of Secondary Education College of Education University of South Florida*. University of South Florida.
- Subagyo, Y., Wiyanto, & Marwoto, P. (2009). Pembelajaran Dengan Pendekatan Keterampilan Proses Sains Untuk Meningkatkan Penguasaan Konsep Suhu Dan Pemuaian. *Jurnal Pendidikan Fisika Indonesia*, 5, 42–46.
- Sugihartono. (2007). *Psikologi Pendidikan*. Yogyakarta: UNY Press.
- Supriyatman, & Sukarno. (2014). Improving Science Process Skills (SPS) Science Concepts Mastery (SCM) Prospective Student Teachers Through Inquiry Learning Instruction Model By Using Interactive Computer Simulation. *International Journal of Science and Research (IJSR)*, 3(2), 6–9.
- Tarmizi. (2010). Ketuntasan Belajar Siswa Melalui Penerapan

Pendekatan Keterampilan Proses Pada Konsep Sistem Gerak Tumbuhan di SMANegeri 3 Pidie. *Jurnal Pendidikan Biologi*, 1(2), 50–58.

Trianto. (2007). *Model Pembelajaran Terpadu Konsep, Strategi dan Implementasi dalam Kurikulum Tingkat Satuan Pendidikan (KTSP)*. Jakarta: Bumi Aksara.

2D INTERPRETATION OF SUBSURFACE HOT SPRING GEOTHERMAL STRUCTURE IN NYELANDING VILLAGE THROUGH SCHLUMBERGER GEOELECTRICITY CONFIGURATION METHOD

Rahmat Nawi Siregar*¹, Widodo Budi Kurniawan²

^{1,2} Physics Department, Universitas Bangka Belitung, Pangkal Pinang, Indonesia

*Correspondence address: rahmatnawisiregar@gmail.com

Accepted: January 10th, 2018. Approved: April 12nd, 2018. Published: April 28th, 2018

Abstract: This research was done on the subsurface structure of Nyelanding village hot spring, Air Gegas district, South Bangka with coordinates 2°44'54.514" South Latitude and 106°16'6.773" East Longitude using the Schlumberger geoelectricity configuration method. Measurements were made on three different tracks. The results of the Schlumberger configuration geoelectricity measurements for the three trajectories indicate the presence of granite rock distribution with resistivity values ranging from 455 – 1046 Ω m.

© 2018 Physics Education, UIN Raden Intan, Lampung, Indonesia.

Keywords: Geothermal hot spring, Schlumberger geoelectricity configuration.

INTRODUCTION

The tectonic plates of Sumatra Island is indicated by the akrasia prism (Simelue Island, Nias Island, Telo Island, Engganau Island, Batu Island and Mentawai Island), the outer arc basin, the volcanic arc (row of volcanoes along the ridge) and the rear arc basin (Bangka Island, Belitung Island and Riau Islands) (Barber, Crow, & De Smet, 2005). This tectonic order will be a means for the emergence of geothermal sources associated with young volcanoes. There are 84 geothermal manifestation points located on the island of Sumatra, and most of them are the result of geothermal thrust originating from volcano magmatic activity. However, some geothermal manifestations such as Pemali, Dendang, Permis and Nyelanding hot springs in Bangka Island are volcanoes that are thought to have nothing to do with volcanic activity (Ananda, Ahman, & Riwanudin, 2013; Pitulima et al., 2016; Santoso, 2016; Setiawan, D & Adhitya, 2013).

The presence of geothermal manifestations in Bangka Island that do not have volcanoes and very low levels of seismicity becomes a challenge for researchers. Research, publications, and literature explaining the phenomenon of non-volcanic geothermal in Indonesia in general and Bangka Island, in particular, are still very small in number.

This is what encourages the writers to do further research on "The Analysis of Subsurface Hot Spring Geothermal Structure in Nyelanding Village through Schlumberger Geoelectricity Configuration Method," which may provide additional literature on non-volcanic geothermal studies in Indonesia.

THEORETICAL FRAMEWORK

Physiographically, Bangka Island is the largest island in Sunda Shift and is represented by hilly terrain with bedrock that limits the South Sumatra Basin in the east and the Sunda Basin in the north (Barber et al., 2005). Nyelanding village is

located in the formation area of Tanjung Genting, where the geology of this area is controlled by the thrust of clay granite rock as shown in Figure 1. The weathered and clotted granite is filled by iron oxide and quartz. In this area also found the existence of sandstone which is the result of weathering of granite (Margono, Supandjono, & E, 1995).

The formation of geothermal systems in several manifestations on Bangka Island is thought to be associated with a large-dimensional plutonic body of rocks, i.e., batholiths, granites from the late Triassic to early Jurassic period. With the old age of rocks, it is estimated that the remaining heat from magma is very little (Purwoto, Rezky, & Simarmata, R, S, 2015).

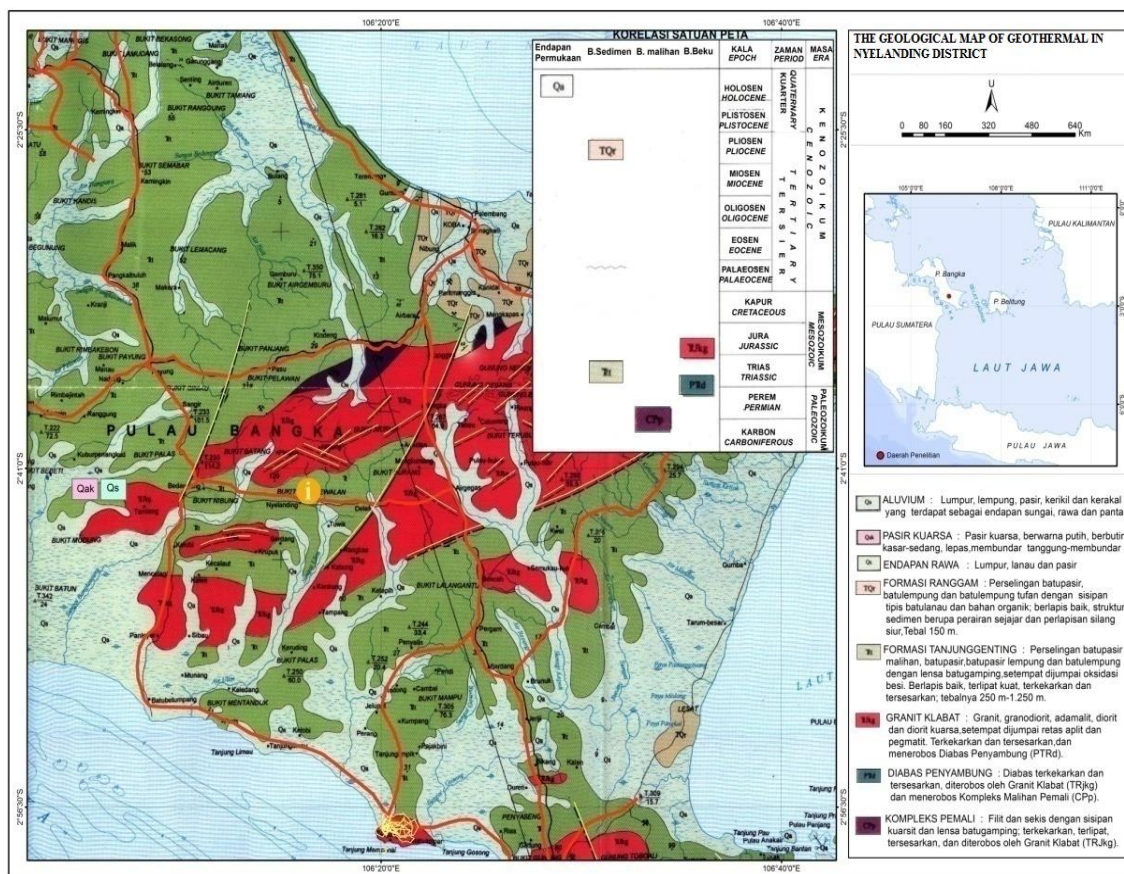

Figure 1. The Geological Map of Geothermal in Nyelending Village

The distribution of plutonic rock as a carrier of radioactive elements follows the direction of the folds and trajectories of the coastline of Bangka Island which follows the direction of specific geological structures of the fold axis. Fracture and fault structures have many orientations. The north-south fault pattern is the youngest fracture phase (Muslim, Kristiyanto, & Endyana, 2015; Permana, Handayani, & Gaffar, 2010). The rising

and normal fault has a relatively northwest-southeast direction, and a horizontal fault with a relatively north-south direction cuts the older fault (Franto, 2015).

Goelectricity method is an active geophysical method that utilizes the Voltage that arises because the electric current is injected into the soil. These Voltages provide information about the shape and electrical properties of non-

homogeneous stratum (Siregar, R, Sinarta, I, Ervan, & Sismanto, 2016). Geoelectricity methods can be used to identify subsurface structures in geothermal investigations. This can be demonstrated by the cross-section of rock type resistance associated with geothermal heat.

Measurement of a resistive type on an isotropic homogeneous medium can be performed on a cylindrical sample as can be seen in figure 2.

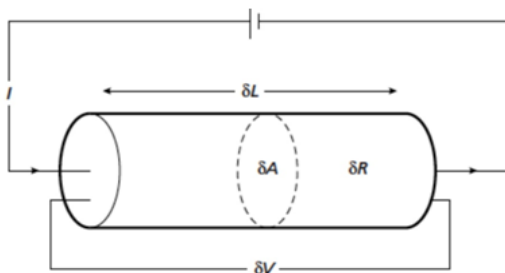

Figure 2. Electric current through a homogeneous cylinder

For a cylinder conductor that has a resistance value of \$\delta R\$, length \$\delta L\$, and width \$\delta A\$ then the resistivity \$\rho\$ can be formulated as :

$$\rho = \frac{\delta R \delta A}{\delta L} \quad [1]$$

The unit of resistivity is ohm-meter (ohm m), and the opposite of resistivity is the conductivity unit of ohm⁻¹ m⁻¹.

Geoelectricity measurements used in the field consisted of two electrons to carry the current (C1 and C2) and two other electrodes (P1 and P2) to measure the current Voltage (Fig. 3). Setting the distance between different current and potential electrodes will give different depth information as well

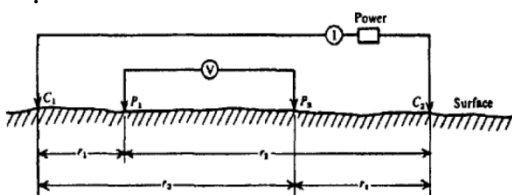

Figure 3. The configuration of the current and potential electrode

The potential in point P1 is

$$V_{\rho 1} = \frac{\rho I}{2\pi} \left(\frac{1}{R_1} - \frac{1}{R_2} \right) \quad [2]$$

The potential in point P2 is :

$$V_{\rho 2} = \frac{\rho I}{2\pi} \left(\frac{1}{R_3} - \frac{1}{R_4} \right) \quad [3]$$

Then the Voltage between the two points is,

$$\Delta V = \frac{\rho I}{2\pi} \left\{ \left(\frac{1}{R_1} - \frac{1}{R_2} \right) - \left(\frac{1}{R_3} - \frac{1}{R_4} \right) \right\} \quad [4]$$

Ten of the apparent resistivity value is:

$$\rho_a = \frac{\Delta V}{I} 2\pi \left(\frac{1}{R_1} - \frac{1}{R_2} - \frac{1}{R_3} + \frac{1}{R_4} \right)^{-1} \quad [5]$$

If k:

$$k = 2\pi \left(\frac{1}{R_1} - \frac{1}{R_2} - \frac{1}{R_3} + \frac{1}{R_4} \right)^{-1} \quad [6]$$

Then,

$$\rho_a = \frac{\Delta V}{I} k \quad [7]$$

With \$k\$ as the electrode geometric configuration.

The geometry factor for each electrode configuration has a different value. The most common configuration used in geoelectric measurements is:

1. Wenner configuration: the distance between \$C_1P_1\$, \$P_1P_2\$, and \$P_2C_2\$ is the same called \$a\$.
2. Schlumberger configuration: the distance of \$C_1O = C_2O = s\$, \$P_1O = P_2O = b\$, with point \$O\$ as the center of configuration with extrincivity value of \$b/s=1/3\$.
3. Dipole-Dipole configuration: the distance of \$C_1C_2 = P_1P_2 = a\$, \$C_2P_1 = na\$ with \$n\$ is the \$n\$-th measurement.

Based on the equation [6], Geometric factors for Schlumberger configuration provided that \$b \ll a\$ is :

$$k_{schlumberger} = 2\pi \left(\frac{a^2}{b} - \frac{b}{4} \right) \quad [8]$$

METHODS

This research was conducted at Nyelanding village, Air Gegas district, South Bangka. The site of the research was $2^{\circ} 44' 54.514''$ South Latitude and $106^{\circ} 16' 6.773''$ East Longitude.

TOOLS AND MATERIALS

The tools and materials used in this research were geoelectricity tools consisting of: superstring R8, Earth imager software, stainless steel electrode, walky-talky, geological hammer, and GPS.

DATA COLLECTING TECHNIQUE

The electricity data collecting technique was:

1. Determining the measurement track area.
2. Install the electrode on the track with spacing between electrodes of a maximum of six meters.

3. Connect all electrodes that have been attached to the switch box with a passive cable.
4. Connect the switch box to the Super Sting R8 / IP tool/console.
5. Check the electrode resistivity contact with the media through the main menu in the tool.
6. Make measurements.
7. Download data from the device to PC.

DATA ANALYSIS TECHNIQUE

The results of the geoelectricity measurements for the Schlumberger configuration using Multichannel Superstring R8 tools are Power current data (I), the Voltage (V), the spacing electrode (A, B, M, N) and type resistance (ρ) in digital * stg. Flow diagram of geoelectricity data processing can be seen in figure 4.

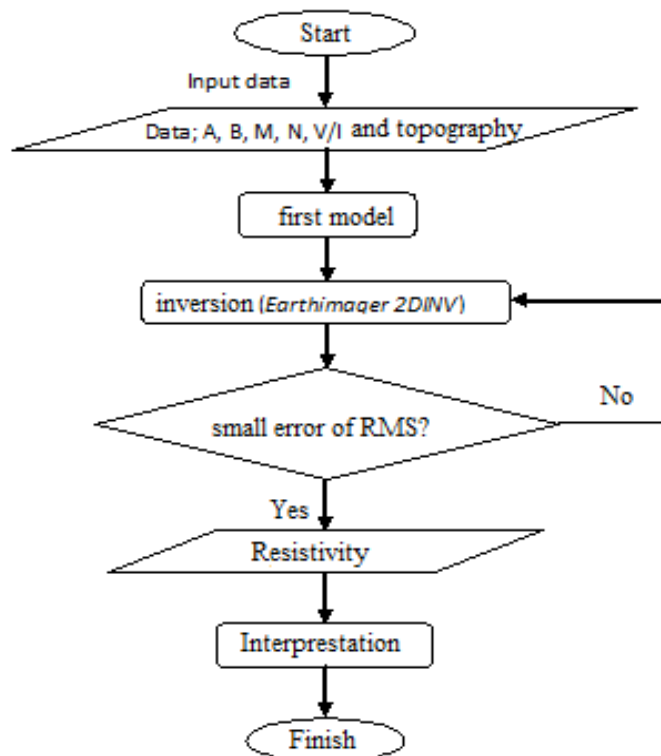

Figure 4. Data Processing Flow Chart

RESULT AND DISCUSSION

In this research, a measurement of Voltage (V) and electric current (I) in 3

different location at east ($106^{\circ}16'21.2''$), north ($106^{\circ} 16' 21.2''$ BT - $2^{\circ} 42' 02.3''$ LS), and west ($106^{\circ}16'19.5''$ BT - 2°

41°59.1" LS) of the Nyelanding hot spring. The resistivity value of the 3 measurement points ranging from 45 to 1046 Ωm .

The measurement diagram on track 1 (east of the hot springs) showed a resistivity value of 56.5 – 1046 Ωm as shown in Figure 5. The granite anomaly (1046 Ωm) was found at 2.5 meters deep with the distance of 9 meters from the starting point of measurement.

A decrease in resistivity around granite rocks showed a resistivity of 455-690 Ωm interpreted as sandstone. Sandstone is the result of weathering granite rocks. At a distance of 12 meters from the starting point of measurement (west of the site), the resistivity diagram showed the presence of groundwater at a resistivity of 56.6 Ωm .

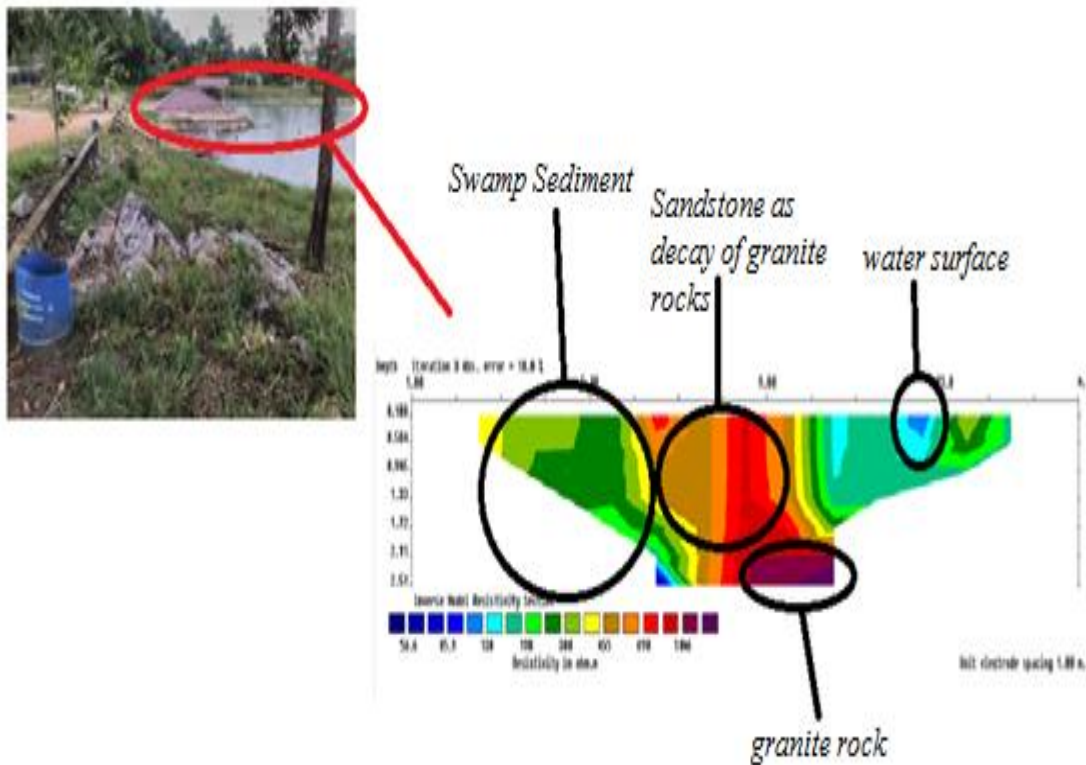

Figure 5. Resistivity diagram of track 1

The track 2 located at the north of the hot spring showed a resistivity diagram ranging from 45 - 322 Ωm . On this track, granite rock outcrops were found at the starting point of measurement. At a distance of 3 - 5 meters, resistivity showed the existence of granite rocks with a resistivity of 332 Ωm at a depth of 0.9 meters. At a distance of 8 - 16 meters, the

subsurface structure of the study area showed a low resistivity value, i.e., 45-59.6 Ωm . This anomaly was thought to correlate with swamp and alluvium deposits (Figure 6). At a distance of 33 - 41 Ωm , the resistivity contours showed 185 to 138 m which were interpreted as sandstones,

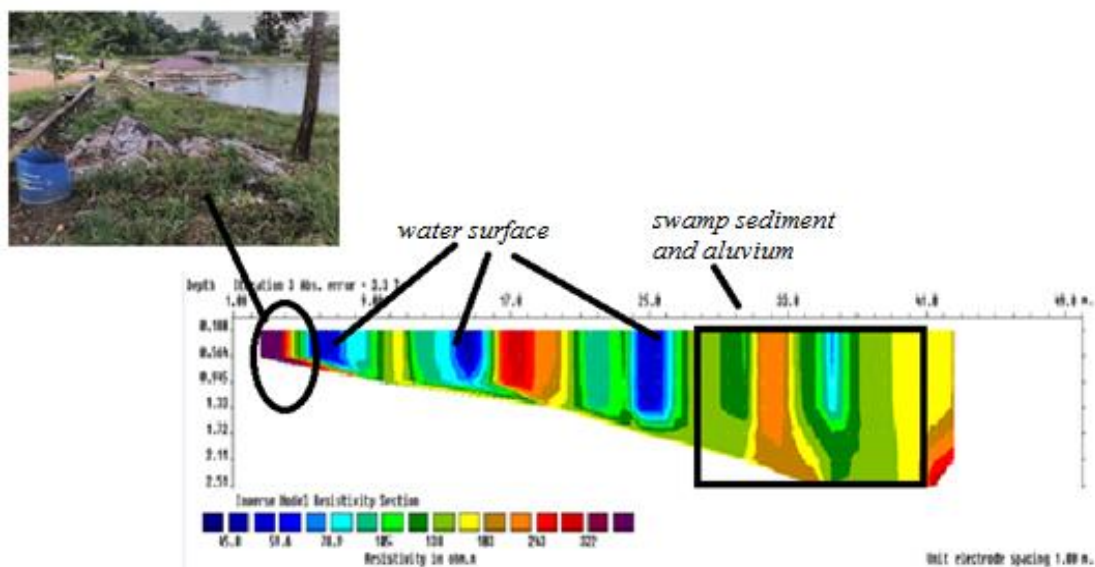

Figure 6. Resistivity diagram of track 2

The resistivity on track 3 showed a very clear granite axial contour as shown in Figure 7. The granite rock outcrop (Figure 5.3) was validated by a resistivity of 300 - 452 Ω m at a depth of 2.5 meters to 7-10 meters from the initial measurements

point. An estimated fracture as a heat exit-way from the carrier rock to interact directly with the surrounding layer was shown by the resistivity difference at a distance of 4-7 meters from 0.5 – 2.1-meter depth.

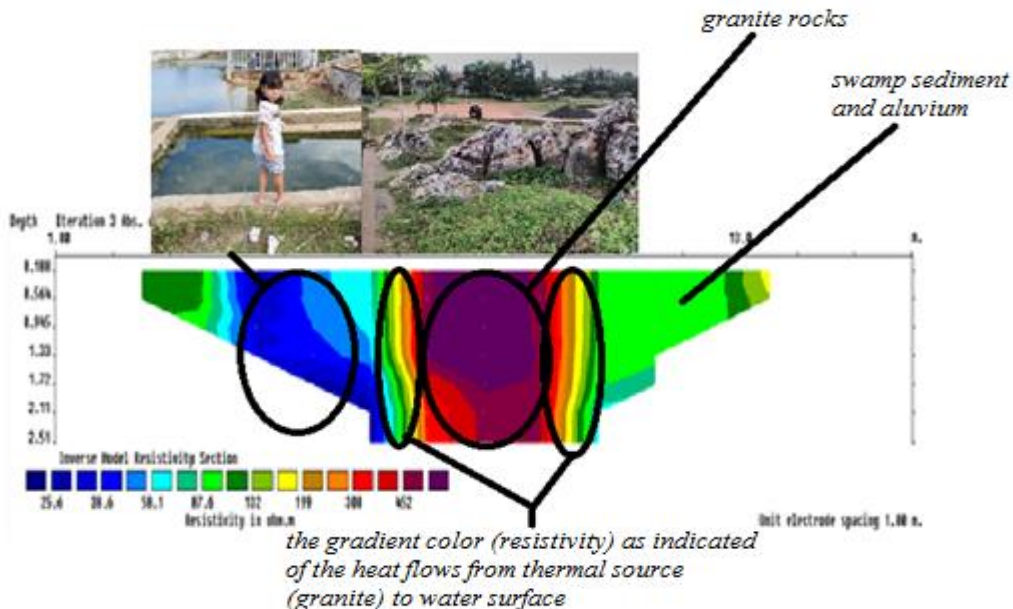

Figure 7. Resistivity diagram of track 3

CONCLUSION

Based on the research results, it was found in the resistivity diagram the existence of granite around Nyelanding hot spring with resistivity on track 1 (east of hot spring) showing resistivity value of 56,

5 - 1046 m, on Track 2 which located at the north of the hot spring showed a resistivity diagram ranging from 45 - 322 m and a resistivity value approximately 300 - 452 m. Track 3 showed a very clear granite anomaly contours. High resistivity data

indicated that the geological structure of the study area unrelated to the common hydrothermal alteration of rocks in the volcanic region.

ACKNOWLEDGMENT

The researcher's gratitude is dedicated to the University of Bangka Belitung which has provided support through University Lecturer Research Grant.

REFERENCES

- Ananda, R. P., Ahman, E., & Riwanudin, O. (2013). Pengaruh Physical Evidence Objek Wisata Pemandian Air Panas Ciwalini Terhadap Keputusan Berkunjung Wisatawan (Survei Pada Wisatawan Nusantara Pemandian Air Panas Ciwalini-Ciwidey Kabupaten Bandung). *Tourism and Hospitality Essentials Journal*, III(1), 461–482.
- Barber, A. ., Crow, M. ., & De Smet, M. E. . (2005). Sumatra: Geology, Resources and Tectonic Evolution. *Geological Society Memoir*, 234–257.
- Franto. (2015). Interpretasi Struktur Geologi Regional Pulau Bangka Berdasarkan Citra Shuttle Radar Topography Mission (SRTM). *Jurnal Promine*, 3(1), 10–20.
- Margono, U., Supandjono, R., & E, P. (1995). *Peta Geologi Lembar Bangka Selatan, Sumatera*. Bandung: Pusat Penelitian dan Pengembangan Geologi.
- Muslim, D., Kristiyanto, T. H., & Endyana, C. (2015). Peran Patahan Aktif Dalam Pengelolaan Sumber Daya Geologi , Studi Kasus : Sumber Daya Lahan Di Wilayah Jatinangor. *Proceeding Seminar Nasional Ke-2 FTG Universitas Padjadjaran*, 56–62. Retrieved from <http://seminar.ftgeologi.unpad.ac.id/wp-content/uploads/2016/03/Peran-Patahan-Aktif-Dalam-Pengelolaan-Sumber-Daya-Geologi.pdf>
- Permana, H., Handayani, L., & Gaffar, E. Z. (2010). Studi Awal Pola Struktur Busur Muka Aceh, Sumatera Bagian Utara (Indonesia): Penafsiran dan Analisis Peta Batimetri. *Jurnal Geologi Kelautan*, 8(3), 105–118.
- Pitulima, J., Siregar, R. N., Pertambangan, J. T., Belitung, U. B., Fisika, J., & Belitung, U. B. (2016). Identifikasi Struktur Geologi Sumber Air Panas Non Vulkanik Desa Nyelending Bangka Selatan. *Prosiding Seminar Nasional Riset Terapan*, 5662, 63–70.
- Purwoto, E., Rezky, Y., & Simarmata, R, S, L. (2015). *Survey Aliran Panas (Heat Flow) Daerah Panas Bumi Permis Kabupaten Bangka Selatan, Provinsi Bangka Belitung*. Bandung.
- Santoso, A. B. (2016). Air Panas Berbelerang di Tirta Tapta Pemali Bangka Ini Bisa Sembuhkan Aneka Penyakit Kulit. *Tribunnews.com*. Retrieved from <http://www.tribunnews.com/travel/2016/02/01/air-panas-berbelerang-di-tirta-tapta-pemali-bangka-ini-bisa-sembuhkan-aneka-penyakit-kulit>
- Setiawan, D, L., & Adhitya, L. (2013). *Geologi dan Geokimia Panas Bumi Daerah Permis Kabupaten Bangka Selatan, Provinsi Bangka Selatan, Kelompok Penyelidikan Panas Bumi*. Bandung.
- Siregar, R, N., Sinarta, I, N., Ervan, M., & Sismanto. (2016). Ground Penetrating Radar and 2-D Electricity Application for Detecting Landslide in Abang District, Karangasem Regency, Bali. *International Journal of Engineering Research and Application*, 6(7).

HOW DO WE SEE THE NON LUMINOUS OBJECTS? 12-13 YEARS OLD STUDENTS' MENTAL REPRESENTATION OF VISION

Konstantinos Ravanis

University of Patras, Greece

Email: ravanis@upatras.gr

Accepted: January 6th, 2018. Approved: April 2nd, 2018. Published: April 29th, 2018

Abstract: In this paper, we present the findings of a research which has two objectives: firstly, it recorded 12-13 years old (7th grade) students' mental representation regarding the vision of non-luminous objects, and, secondly, it emphasized on the relative cognitive fields. The research was done through interviews of 107 urban area students in Greece. The students were asked to explain how objects become visible, stressing the following themes: The manner in which our eyes help us see the objects, whether natural or artificial light helps us see the objects and in what way, and if the objects emit light. The data analysis led to the recording of the students' basic mental representation on the one hand, while on the other hand emphasized the reemission or reflection of light by the luminous objects as a basic mental representation. From the research results, it can be concluded that through a teaching intervention based on mental representation we can foster and enhance scientific thinking and learning about light and vision.

© 2018 Physics Education, UIN Raden Intan, Lampung, Indonesia.

Keywords: light, mental representation, vision, 12-13 years old students

INTRODUCTION

In the context of Science Education, the question of mental representation of phenomena and concepts in the mind of children of all ages has been studied extensively over the past decades (Küçüközer & Bostan, 2010; Ouasri, 2017; Lemmer, Kriek & Erasmus, 2018). The knowledge produced by related research is considered important because it allows us to monitor how a student approaches a certain phenomenon or concept, the main difficulties to the comprehension, the eventual influences of teaching interventions in school (Allen & Kambouri-Danos, 2016; Ampartzaki & Kalogiannakis, 2016; Meli, Koliopoulos, Lavidas & Papalexiou, 2016). The present research paper constitutes a study of 12-13 years old children's representation on vision.

THEORETICAL FRAMEWORK

Human vision is a research subject of various scientific disciplines. Comprehension of the mechanism of vision from a Science or Physics

Education perspective is equally interesting in terms of studying students' mental representation, as well as within the framework of Optics teaching. Truly, the reasonings based on which students interpret the mechanism of vision are determined by the mental representation of light as an autonomous entity in space that is transmitted independently of the light source and the final receiver (Ravanis, 2012). The question of children's minds representation of all ages of concepts and phenomena of physics and especially in geometrical optics, has been studied extensively over the past decades (Dedes & Ravanis, 2009a,b; Gallegos Cázares, Flores Camacho & Calderón Canales, 2009; Tekos & Solomonidou, 2009; Métioui & Trudel, 2010, 2012; Valanides, & Efthymiou, 2012; Castro, 2013; Ntalakoura & Ravanis, 2014; Tsihouridis et al., 2014; Fleck & Hachet, 2015; Kaltakci-Gurell, Eryilmaz & Mc Dermott, 2016, 2017; Herakleioti & Pantidos, 2016; Rodriguez & Castro, 2016; Delserieys, Impedovo, Fragkiadaki & Kampeza, 2017; Impedovo, Delserieys-Pedregosa, Jégou &

Ravanis, 2017; Kuo, Won, Zadnik, Siddiqui & Treagust, 2017; Pantidos, Herakleioti & Chachlioutaki, 2017; Delserieys, Jegou, Boilevin & Ravanis, 2018;). The knowledge created by related research is considered significant because it allows us to monitor how a student approaches a certain concept, the main obstacles to its comprehension, the probable inspirations of teaching interventions in the classroom, and the way a child's thought process develops up until childhood. Based on this mental representation, children's reasoning allows us to determine the limits to the effectiveness of experimental activities in which the process of vision assumes a decisive role.

As exhibited in various international researches, students utilize various types of interpretations, explanations, and argumentations when they attempt to explain which natural process or mechanism enables us to see (Selley, 1996; De Hosson, 2004; Dedes, 2005; Anthopoulou & Ravanis, 2016). Many such interpretations are incompatible with the characteristics of the model used in education, based on which vision occurs when the light is emitted by self-luminous objects and reemitted by non-luminous objects (Ravanis, 2000; Kokologiannaki & Ravanis, 2012, 2013).

According to the classic taxonomy of Selley (1996), nine different mechanisms have been formulated in the matter of vision:

1. **Cooperative Emission:** Both the eye and the light source emit light towards the objects.
2. **Stimulated Emission:** The light reaches the eye and is then retransmitted or causes the emission of a light beam towards the objects.
3. **Simple Emission:** The eye sends light to the objects.
4. **Stimulated Emission with Reflection:** The light leaves the light source, reaches the eye, is then

retransmitted or provokes a secondary emission towards the objects. The objects then retransmit the light, which returns to the eye.

5. **Primary Reception:** The light source lights the eye – this model involves primary light sources.
6. **Secondary Reception:** The light travels from the light source first to the objects, then to the eye – this model involves objects retransmitting light from a primary light source.
7. **Secondary Receptor-Emission:** The light travels from the light source to the objects, it then “bounces” towards the eye, and the eye then emits something towards the objects.
8. **Sea of Light:** The light source generally lights the space, and this is the reason why we can see.
9. **Dual Illumination:** The light source lights both the eye and the objects at the same time.

Broadly, the categories of children's answers are based on descriptive characteristics such as those to which we referred previously. With this illustration, we map different mental representation on the vision which can serve as the basis for the location of cognitive obstacles in the children's thought process. These obstacles render the approach of the phenomenon of vision, using the Geometrical Optics standard, impossible.

Indeed, these representations are often characterized as models. Given that each respective thought entity does not necessarily constitute a mental model, this characterization is excessive. To be sure, we nowadays recognize that, in order for a representation to be classified as a model, it must lead to functions such as description, explanation, and prediction (Genzling & Pierrard, 1994; Ravanis, 2010). The confusion of mental models with simple mental representation would

not be of such significance if it did not obstruct the comprehension of the true nature of problems and difficulties. Truly, models are distinguished by an internal structure whose transformation requires special efforts, while simple representation is more easily adapted to scientific model characteristics. Therefore, the exposition of various representations concerning vision, even if encountered in literature in the form of models, does not lead to the conceptualization of critical impediments to teaching.

In the research presented here, we attempted to study students' mental representation concerning vision. However, we prioritized the emphasis on basic obstacles to education instead of describing problems in their thought process.

METHOD

The research sample included 107 students 12-13 years old (51 boys and 56 girls, average age: 12 years and 8 months), from 7 class (grade 7) of 4 public schools in Patras, an urban area of Greece. These students had chosen courses covering the fundamentals of Optics in grades 5 and 6. The sample only included children volunteers which we found to identify autonomous entity properties within the light, while we did not include children that connected light with light sources and/or their results.

The Research Procedure

The research of the children's representation was carried out through individual semi-directive interviews which were 10-12 minutes long, in a specifically prepared laboratory space with natural and artificial lighting.

We asked each child to explain how we saw an everyday non-luminous object (a box, a mug, a chair, a ball) and based on their initial answer there followed a conversation. Within the framework of that conversation, we attempted to note the

interpretive structure used in order to approach the problem of seeing these objects. Specifically, we asked the children to explain "how our eyes help us see the objects," "whether natural or artificial light help us see the objects and in what way," and, finally, "whether the objects emit light." The interviews were recorded and their analysis was realized based on the transcript of the recording. Simultaneously, an observation protocol was kept for each student. The data processing was carried out based on the transcribed text and the researcher's observation protocols.

RESULTS AND DISCUSSION

Results

During the interview, we posed the children questions asking them to explain the mechanism to which they attribute the ability to see a colorful object, the role of the eyes within that mechanism, the significance of diffuse natural lighting and the possibility of light emission by the objects.

The processing of data collected from the interviews allowed us to discern a series of alternative parameters or relationships between parameters used by children of that age in order to explain the problem of the mechanism of vision. Consequently, we will present three categories of mental representation which were conceptualized based on the data analysis: sufficient, intermediate and insufficient representation.

Sufficient answers

To begin with, when examined from a descriptive perspective, our findings resemble those of the aforementioned researches. 21.4% of students (23/107) interpret vision as a process of reflection or reemission of light towards the eyes from objects that receive light rays. Naturally, we do not discern processed mental representation in children's thought; to be sure, these representations would require

familiarity with issues such as light absorption or the formation of colors. Therefore, based on children's answers, in certain instances, the eyes receive light, whereas in other cases they receive "images," "rays", or "colors". However, the use of reasonings based on the attribution of a "transmitter" and "receiver" role to the objects simultaneously organizes children's thought with functional thoroughness towards the comprehension of the process of vision. Let us examine two relevant conversation examples.

Extract 1: **Researcher (R)**. How are we able to see this mug? **Student 71 (S.71)**. With our eyes and because there is light. **R**. So, what exactly takes place that makes us see the mug? **S.71**. What happens? So... let's say that there is sunlight everywhere... it sheds on the box, and the box sends it around... there is reflection... **R**. And what about our eyes? **S.11**. Oh yes... some rays also go towards our eyes so we can see the box...

Extract 2: **R**. How are we able to see this box? **S.16**. Light is shed, which has various rays, red, blue, green... the box keeps some of them, while it reflects and turns away others. **R**. How do our eyes help us see the box? **S.16**. The radiance reflected by the box goes to our eyes. **R**. Does the box give out the light? **S.16**. Not on its own... it only sends away what it cannot withhold... I don't know how to explain how that happens...

Intermediate answers

We classified answers of 19/107 students in the second category, in which there are references to the role of the objects as "receiver" and "transmitter". However, very often these references remain vague, hesitant, contradictory and confused. In these answers, children sometimes appear to understand the functional role of eyes, while other times they appear not to. Consequently, we

present two examples of conversations with the children.

Extract 3: **R**. Can you explain to me now how we are able to see this chair before us? **S.33**. How are we able to? We are... because rays of sunlight shed on it. **R**. What happens then? **S.33**. Something happens... our eyes can see it. **R**. Would you like to explain this in more detail... So what do the rays of sunlight do, the chair, the eyes... **S.33**. The rays, as I told you before, go towards the box and they light it. Then they go away from the box and... that is how we can see it. **R**. How do they go away from the box? **S.33**. Umm... they go away from it, and we can see them. **R**. And what about the eyes... what do the eyes do? **S.33**. The eyes see the things. **R**. How do they see them? Umm... the image that is coming is imprinted on them... **R**. The image? What image? **S.33**. In this case, for example, the image of the box that we can see. **R**. Are the rays you told me were going away from the box before and the image the same thing? **S.33**. No, the rays and the images are two different things.

Extract 4: **R**. How are we able to see this box? **S.46**. Certain colors enter our eyes... they are reflected... let's say that all colors except for yellow enter our eyes and in this way we can see it. **R**. You said they are reflected... what exactly do you mean by that? **S.46**. The rays are reflected... but are they reflected on the box? **R**. What do you think? **S.46**. ... The light that is shed on the box has many colors... some of them stay on the box, and others go away... they are reflected. We can see those that stay in the box. **R**. How? **S.46**. We can see them since they stay on the box.

Insufficient answers

Finally, we classified the largest part of the answers, namely more than 6 out of 10 answers (63/107), in a third category. In the answers belonging to this category, there is no recognition of a systematic

relationship between light, objects, and vision. Vision is generally attributed to the light that falls on the objects; the eyes, which simply have the potential to observe, can regard the objects when it is lit. We provide a typical example of the conversation (5) that follows.

Conversation 5: **R.** Do you want to tell me now how we are able to see this ball on the floor? What I mean is, how can we see things? **S88.** We see it with our eyes. **R.** What do the eyes do? **S88.** They look and see. **R.** Does light do something that helps us see? **S88.** The light lights. **R.** What do you mean by that? **S88.** It comes from the sun, from the lamps... and lights on things. **R.** I see... and how can we see them?

S88. We see them since they are lit. **R.** Could you explain in a few words what happens with sunlight? **S88.** Light starts from the sun and, in a few minutes, comes everywhere and so we can see everything. It lights on the desk, the chairs... it lights and, on the ball, that you asked me about. **R.** Is light leaving the box? **S88.** From the box? Umm... no, I do not think so... There is not any light in the box... **R.** Are you thinking something about it? **S88.** No... light only comes from lamps and the sun.

In the following table (1) we present the allocation of the answers of all the children in the sample in these three categories.

Table 1. The children’s answers: categories and frequencies

No	Categories	Frequency	Percentage
1	Sufficient answers	23	21.5%
2	Intermediate answers	19	17.8%
3	Insufficient answers	65	60.7%
Total		107	100%

Discussion

This research’s results appear to confirm up to a certain extent relevant researches’ finding, while also highlighting certain differences (Selley, 1996). A significant difference from a qualitative standpoint is the absence of mental representation that ascribes an active role to the eyes, as in our instance we did not encounter children that used such a mental representation concerning eye function. From a qualitative standpoint, the relatively large percentage of children using a sufficient mental representation about vision constitutes an interesting difference. Nevertheless, both of these data could be related to the choice of the sample; namely, students which already grasped light as an entity in space and independent of the light source and the final receiver (Ravanis & Boilevin, 2009;

Castro & Rodriguez, 2014; Grigorovitch, 2014, 2015).

However, in the case of the research presented in this article, the basic question was not the exploration of mental representation. Truly, in a large number of relevant papers, we can encounter documentation of children’s reasonings in which all findings, in a way, are treated as equivalent (Anthopoulou & Ravanis, 2016). The analysis of empirical material carried out here was based on the effort to approach problems of children's thought that constitute obstacles to the understanding of the vision mechanism. Indeed, as is shown in the results, not all mental representation that was recorded bear the same significance.

If we closely examine reasonings which imply that children encounter difficulties, we observe that all these

students that do not sufficiently represent eye function in their thought in no way refer to the process of re-emission or reflection of light on objects; instead, they simply invoke their lighting.

In contrast, those students which refer to reflection face no difficulties in describing the eye as a receiver of light. Therefore, it is meaningless from a teaching standpoint to refer to two different problems faced by students, namely the role of the eyes and the reemission of light from objects. This is so because it appears that reemission constitutes a prerequisite not only for the construction of a sufficient mental representation for eye function but also mainly for the very recognition of such a matter.

The same hypothesis could be drawn concerning relevant problems that arise while encountering the interaction between light and objects. The differentiation traced between children that attribute the lighting of objects to diffuse light, and other children that invoke the shedding of light on other objects can be regarded as being less interesting if we examine reasonings of children that think based on the reemission of light. Truly, initial references related to the lighting of objects do not appear to be significant in these reasonings. In contrast, we could argue that recognition of re-emission can also restructure the thought of children whose formulations were ambiguous during the interview's first stage.

CONCLUSIONS

In this paper, the mental representation of 12-13 years old student concerning the non-luminous objects vision was recorded. The research results showed that, even though the children have experiences with this phenomenon, they encounter significant obstacles during the approach of several of its traits.

The combined use of research findings on light, its reemission by objects, as well

as the role of eyes in vision allows us to trace the recognition of re-emission as a fundamental cognitive obstacle in children's thought.

Therefore, within the framework of any teaching related to the mechanism of vision, it is particularly meaningful to turn towards the matter of surpassing this obstacle, as the familiarisation with the phenomenon of reemission allows for both the functional use of light as an autonomous entity, as well as the attribution of a receiving role to the eyes. Besides, the understanding of the matter of vision is greatly significant in the teaching of the entire Optics field. This is true since, on the one hand, there arise issues such as the formation of reflections in mirrors and lenses, as well as the existence of colours, the understanding of which requires the understanding of vision, while, on the other hand, the formation of mental representation in any subject of Optics that are incompatible to scientific models enter the thought process through a single gateway: the eyes.

REFERENCES

- Allen, M., & Kambouri-Danos, M. (2016). Substantive conceptual development in preschool science: contemporary issues and future directions. *Early Child Development and Care*, 187(2), 181-191.
- Ampartzaki, M., & Kalogiannakis, M. (2016). Astronomy in Early Childhood Education: a concept-based approach. *Early Childhood Education Journal*, 44, 169-179.
- Anthopoulou, V., & Ravanis, K. (2016). How do we see when the light is not "enough"? Mental representation of pre-service preschool teachers. *International Education and Research Journal*, 2(8), 30-32.

- Castro, D. (2013). Light mental representation of 11-12-year-old students. *Journal of Social Science Research*, 2(1), 35-39.
- Castro, D., & Rodriguez, J. (2014). 8-9-year-old pupils' mental representation of light: teaching perspectives. *Journal of Advances in Natural Sciences*, 2(1), 40-44.
- De Hosson, C. (2004). *Contribution à l'analyse des interactions entre l'histoire et didactique des sciences. Élaboration d'un support d'enseignement du mécanisme optique de la vision pour l'école primaire et le collège et premiers éléments d'évaluation*. Université Paris-Diderot - Paris VII, France.
- Dedes, C. (2005). The mechanism of vision: Conceptual similarities between historical models and children's representation. *Science & Education*, 14, 699-712.
- Dedes, C., & Ravanis, K. (2009a). Teaching image formation by extended light sources: The use of a model derived from the history of science. *Research in Science Education*, 39(1), 57-73.
- Dedes, C., & Ravanis, K. (2009b). History of science and conceptual change: the formation of shadows by extended light sources. *Science & Education*, 18(9), 1135-1151.
- Delserieys, A., Impedovo, M.-A., Fragkiadaki, G., & Kampeza, M. (2017). Using drawings to explore preschool children's ideas about shadow formation. *Review of Science, Mathematics and ICT Education*, 11(1), 55-69.
- Delserieys, A., Jegou, C., Boilevin, J.-M., & Ravanis, K. (2018). Precursor model and preschool science learning about shadows formation. *Research in Science and Technological Education*, DOI 10.1080/02635143.2017.1353960.
- Fleck, S., & Hachet, M. (2015). Helios: a tangible and augmented environment to learn optical phenomena in astronomy. In *Proceedings of ETOP - Education and Training in Optics and Photonics* (pp. 979331-979336), Bordeaux, France: SPIE.
- Gallegos Cázares, L., Flores Camacho, F., & Calderón Canales, E. (2009). Preschool science learning: The construction of representation and explanations about color, shadows, light and images. *Review of Science, Mathematics and ICT Education*, 3(1), 49-73.
- Genzling, J.-C., & Pierrard, M.-A. (1994). La modélisation, la description, la conceptualisation, l'explication et la prédiction. In J.-L. Martinand (Ed.), *Nouveaux regards sur l'enseignement et l'apprentissage de la modélisation en sciences* (pp. 47-78). Paris: INRP.
- Grigorovitch, A. (2014). Children's misconceptions and conceptual change in Physics Education: the concept of light. *Journal of Advances in Natural Sciences*, 1(1), 34-39.
- Grigorovitch, A. (2015). Teaching optics perspectives: 10-11 year old pupils' representation of light. *International Education & Research Journal*, 1(3), 4-6.
- Herakleioti, E., & Pantidos, P. (2016). The contribution of the human body in young children's explanations about shadow formation. *Research in Science Education*, 46(1), 21-42.
- Impedovo, M. A., Delserieys-Pedregosa, A., Jégou, C., & Ravanis, K. (2017). Shadow formation at preschool from a socio-materiality perspective. *Research in Science Education*, 47(3), 579-601.
- Kaltakci-Gurell, D., Eryilmaz, A., & McDermott, L. C. (2016). Identifying pre-service physics

- teachers' misconceptions and conceptual difficulties about geometrical optics. *European Journal of Physics*, 37(4), 045705-35.
- Kaltakci-Gurell, D., Eryilmaz, A., & McDermott, L. C. (2017). Development and application of a four-tier test to assess pre-service physics teachers' misconceptions about geometrical optics. *Research in Science & Technological Education*, 35(2), 238-260
- Kokologiannaki, V., & Ravanis, K. (2012). Mental representation of sixth graders in Greece for the mechanism of vision in conditions of day and night. *International Journal of Research in Education Methodology*, 2(1), 78-82.
- Kokologiannaki, V., & Ravanis, K. (2013). Greek sixth graders mental representation of the mechanism of vision. *New Educational Review*, 33(3), 167-184.
- Kuo, Y. R., Won, M., Zadnik, M., Siddiqui, S., & Treagust, D. F. (2017). Learning Optics with multiple representation: not as simple as expected. In D. Treagust, R. Duit & H. Fischer (Eds), *Multiple representation in Physics Education. Models and modeling in Science Education*, v. 10 (pp. 123-138). Cham: Springer.
- Küçüközer H., & Bostan A. (2010). Ideas of kindergarten students on the Day/Night cycles, the seasons and the moon phases. *Journal of Theory and Practice in Education*, 6(2), 267-280.
- Lemmer, M., Kriek, J., & Erasmus, B. (2018). Analysis of students' conceptions of basic magnetism from a complex systems perspective. *Research in Science Education*, <https://doi.org/10.1007/s11165-018-9693-z>.
- Meli, K., Koliopoulos, D., Lavidas, K., & Papalexiou, G. (2016). Upper secondary school students' understanding of adiabatic compression. *Review of Science, Mathematics and ICT Education*, 10(2), 131-147.
- Métioui, A., & Trudel, L. (2010). Evolution of student teachers' conceptions about light following constructivist didactic activities. In M. Nodzysk & J. R. Pasko (Dir.). *Research in Didactics of the Sciences: Monograph* (pp. 249–252). Krakov, Poland: Pedagogical University of Krakov.
- Métioui, A., & Trudel, L. (2012). The model of the rectilinear propagation of light and the study of the variation of the size of a shadow. *US-China Education Review*, 2(9), 173-186.
- Ntalakoura, V., & Ravanis, K. (2014). Changing preschool children's representation of light: a scratch based teaching approach. *Journal of Baltic Science Education*, 13(2), 191-200.
- Ouasri, A. (2017). Analyse des difficultés des élèves marocains de 15-16 ans en résolution de problèmes de mécanique (mouvement et repos, interactions mécaniques et forces, poids et masse). *Review of Science, Mathematics and ICT Education*, 11(2), 69-92.
- Pantidos, P., Herakleioti, E., & Chachlioutaki, M.-E. (2017). Reanalysing children's responses on shadow formation: a comparative approach to bodily expressions and verbal discourse. *International Journal of Science Education*, 39(18), 2508-2527.
- Ravanis, K. (2000). How do we see objects that reflect light? Experiential mental representation of students of 12-13 years old, about vision. In N. Valanidis (Ed.), *Second*

- Panhellenic Conference on Teaching of Science and Application of New Technologies in Education* (v. I, pp. 214-221) Nicosia: Department of Education, University of Cyprus.
- Ravanis, K. (2010). Représentations, Modèles Précurseurs, Objetsifs-Obstacles et Médiation-Tutelle : concepts-clés pour la construction des connaissances du monde physique à l'âge de 5-7 ans. *Revista Electrónica de Investigación en Educación en Ciencias*, 5(2), 1-11.
- Ravanis, K. (2012). Représentations des enfants de 10 ans sur le concept de lumière: perspectives piagétienne. *Schème - Revista Eletrônica de Psicologia e Epistemologia Genéticas*, 4(1), 70-84.
- Ravanis, K., & Boilevin, J.-M. (2009). A comparative approach to the representation of light for five-, eight- and ten-year-old children: didactical perspectives. *Journal of Baltic Science Education*, 8(3), 182-190.
- Rodriguez, J., & Castro, D. (2016). Changing 8-9-year-old pupil's mental representation of light: a metaphor based teaching approach. *Asian Education Studies*, 1(1), 40-46.
- Selley, N. J. (1996). Children's ideas on light and vision. *International Journal of Science Education*, 18(6), 713-723.
- Tekos, G., & Solomonidou, C. (2009). Constructivist learning and teaching of optics concepts using ICT tools in Greek primary school: a pilot study. *Journal of Science Education and Technology*, 18, 415-428.
- Tsihouridis, C., Vavougiou, D., Ioannidis, G. S., Alexias, A., Argyropoulos, C., & Poullos, S. (2014). Using sensors and data-loggers in an integrated mobile school-lab setting to teach Light and Optics. In *Interactive Collaborative Learning (ICL), 2014 International Conference on Interactive Collaborative Learning* (pp. 439-445). Dubai, United Arab Emirates: IEEE Xplore.
- Valanides, N., & Efthymiou, I. (2012). Student representation of progressively more complex shadow and penumbra phenomena: a way towards conceptual change. In M. D. Avgerinou, B. Chandler, P. Search, & M. Terzic (Eds), *New horizons in visual literacy* (pp. 216-230). Šiauliai, Lithuania: Scientia Educologica.

ANALYSIS OF PHYSICS LABORATORY MANAGEMENT AT THE NORTHERN REGION OF MAKASSAR'S STATE SENIOR HIGH SCHOOLS BY STANDARD OF FACILITIES AND INFRASTRUCTURE

Santih Anggereni*¹, Muh. Syihab Ikbal²

^{1,2} Physics Education Department, Tarbiyah and Teacher Training Faculty, UIN Alauddin Makassar

*Correspondence address: santih.anggereni@uin-alauddin.ac.id

Accepted: October 7th, 2017. Approved: March 8th, 2018. Published: April 28th, 2018

Abstract: This research is descriptive research that aims to know: 1). Description of physics laboratory management related to the layout based on the standard of facilities, 2). The description of the management of physics-related physics laboratory based on the standard of facilities, and 3). Description of the management of the physics laboratory related to safety and health based on the standard of facilities and infrastructure. The population of this research was six state senior high schools (SMAN) in the north region of Makassar. Three samples were obtained by purposive sampling. The results Showed that the management of the layout of the physics had met the standard. Spatial Management of the laboratories was categorized as less appropriate with the standards. Occupational Health and safety (OHS) is categorized as less appropriate with the standards. Based on the results obtained it can be concluded that only in the aspect of the management of the physics laboratories' layout is in line with the regulation of the Ministry of National Education No.24, 2007.

© 2018 Physics Education, UIN Raden Intan, Lampung, Indonesia.

Keywords: Work safety, physics laboratory, layout management, spatial management.

INTRODUCTION

Physics is a science that requires observations and measurements made through experiments. Observation of natural phenomena is done by observing and analyzing the factors of cause and effect that interrelate and affect each other. In general, natural phenomena do not provide an opportunity to analyze the effects experienced. This can be overcome by experimenting where various influences are designed beforehand, and the desired state is controlled as well. Experiments take a very important role in the development of modern science and place the importance of working in laboratories for students and researchers (Sani, 2012).

One of the prerequisites in learning or practice of science in laboratory utilization. Therefore, it is necessary to have a good management system or science laboratory management.

Laboratory management has an important role in realizing the effectiveness of science learning (Novianti, 2011). A laboratory is a place where experimental and research activities are conducted. This place can be a closed or open room (Mastika, Adnyana, & Setiawan, 2014). The Regulation of the Ministry of National Education no. 24 of 2007, described the laboratory equipment standard and infrastructure that must be considered by the educational units in managing the laboratory. The standard in question is about the layout, spatial layout, and safety in the laboratory.

The existence of science laboratories in the First and Secondary Schools play a role in supporting the teaching and learning process in the field of science through the understanding of natural phenomena as a result of observations that could produce Students who are able to do the analytical, critical, and creative

thinking. The procurement of science tools in schools plays a role to increase the laboratory's efficiency in accordance with the progress of Science and Technology (Darsana, Sadia, & Tika, 2013).

As a part of science learning, physics learning also requires a laboratory. This physics laboratory is expected to be a place for the development of students' mindset and scientific attitude. In the laboratory, students and teachers conduct the learning in the form of practicum and research. Teachers can use laboratory facilities for practicum activities, where practicum activities are an integral part of teaching and learning activities. The laboratory becomes the scope of the National Education Standards concerning the minimum criteria required to support the learning process including technology and communication (Imastuti, Wiyanto, & Sugianto, 2016).

Anwar states that the implementation of Physics practice in the field now still faces many obstacles (Anwar, E., 2014). Problems faced by teachers in conducting practicum such as lack of equipment, materials, and lack of knowledge and skills of the teachers in managing practicum activities. In addition, the absence of assistants who assist teachers and too many students make it difficult to regulate the process of activities.

According to Novianti, the utilization of science laboratory will be maximized if it is supported by management or system that is in accordance with the standard set in the Regulation of the Ministry of National Education (Novianti, 2011). As the result of Yaman's research confirms that science laboratories should be managed and empowered into an ideal laboratory, for instance, the condition of science laboratory in SMPN 7 Kubung produced very far from ideal conditions (less appropriate with the Regulation of the Ministry of National Education) (Yaman, 2016). It requires a competent Head of Laboratory personality, social, managerial,

and professional ability in managing laboratory, so that laboratory can be functioned optimally. The accuracy of management will have an impact on the success of science learning, so it is necessary to analyze the management of science laboratories conducted in schools, especially in his study that was focused on the competence of the laboratory managers themselves.

Based on preliminary observations, schools in the northern region of Makassar have physics laboratories. However, the laboratories at the schools are not used according to its function. There are laboratories that are used as multifunction rooms; in this case, they are used as classrooms and warehouses. In addition, the management of the laboratories' physical layout, equipment's, and materials are not prepared in accordance with their respective characteristics. This state of physics laboratory, as obtained from the observation, certainly gives an impact on the process of physics learning, especially on practical activities.

A study conducted by Ali (2015) on the performance of physics laboratories in Islamic senior high schools in the city of Makassar shows that the performance of the head of the laboratory of schools is in a low category (Ali, 2015). However, the study did not look at the arrangement or management of laboratory space, laboratory layout and the operational health and safety (OHS).

Based on the description, it was deemed necessary to conduct research under the title "Analysis of Physics Laboratory Management at the Northern Region of Makassar's State Senior High Schools by Standard of Facilities and Infrastructure."

The purpose of this research was to investigate the description of physics laboratory management based on the standard of facilities and infrastructure in

terms of layout, spatial layout, and laboratory health and safety.

METHOD

This research is quantitative descriptive research. According to Subana, descriptive research is a research that aims to investigate facts, circumstances, variables, and phenomena occurred and then present it as it is (Subana & Sudrajat, 2011).

The approach used in this research was a direct observation on the object of research related to the layout, spatial layout, and the aspects of occupational safety and health.

The population of the study was all State Senior High Schools located in the northern region of Makassar. Three samples were obtained through purposive techniques, namely SMAN 18 Makassar, SMAN 21 Makassar and SMAN 22 Makassar. The three schools sampled are schools that have unintegrated science laboratories (Physics, Biology, and Chemistry).

The instruments used in this research were 1) observation sheet, used to see the suitability of laboratory with the Regulation of the Ministry of Education in terms of management of layout, spatial, tools and laboratory materials, 2) interview guides, used to obtain additional information from the school about laboratory management, and 3) documentation, used to document the findings obtained during the research of the aspects studied.

The data obtained was processed by descriptive analysis, by using the formula of average and the formula of proportion, as stated in Siregar, as follows (Siregar, 2014):

$$\bar{X} = \frac{\sum X}{N} \tag{1}$$

- \bar{X} = Average Score
- X = Obtained Score
- N = Observed Aspects

To determine the percentage of categories used the formula proportion as follows:

$$P = \frac{f}{N} \times 100\% \tag{2}$$

- P = Percentage
- f = Frequency
- N = Number of Sample

The range of values used to define the laboratory management category follows the value range of laboratory as follows:

Table 1. Categorization of laboratory management

Range	Category
91 – 100	Highly Appropriate
76 – 90	Appropriate
61 – 75	Quite appropriate
51 – 60	Less Appropriate
0 – 50	Inappropriate

RESULT AND DISCUSSION

RESULT

a. Description of Physics laboratories Layout Management

Data on research results related to the management of physics laboratories for layout aspects can be seen in the following table:

Table 2. Recapitulation of physics laboratory management data for layout aspect

No	Schools	Score
1	SMAN 18 Makasar	80
2	SMAN 21 Makasar	90
3	SMAN 22 Makasar	80
Average		80

Based on the data in table 2, the description of physics lab management for the layout aspect can be categorized based on the following table 3:

Table 3. Category of Physics laboratory management for layout aspect

Range	<i>f</i>	Category	%
91-100	0	Highly Appropriate	0
76-90	3	Appropriate	100
61-75	0	Quite Appropriate	0
51-60	0	Less Appropriate	0
0-50	0	Inappropriate	0

Based on table 3, recapitulation of physics lab layout category, the average score of management of physics lab layout of the State Senior High schools at the northern area of Makassar was in good category the percentage of 100%, so it can be concluded that the layout of physics laboratory of the State Senior High schools in the northern area of Makassar was in accordance with standard of the Regulation of the Ministry of National Education No.24 of 2007 (Depdiknas, 2007).

b. The Description of Physics Laboratory Management on Spatial aspects

Data of research results related to the management of physics laboratory is in the following table:

Table 4. Recapitulation of physics laboratory management data for spatial aspects

Schools	1	2	3	Total	Score
I	26	84	14	124	60
II	28	120	13	161	78
III	20	87	15	122	59
Average					66

Explanation:

- I = SMAN 18 Makassar
- II = SMAN 21 Makassar
- III = SMAN 22 Makassar
- 1 = Spatial Inventories
- 2 = Learning Equipment
- 3 = Terms of the condition of facilities and infrastructure

Based on the data in table 4, the description of physics lab management for spatial aspects can be categorized based on the following table 5:

Table 5. Category of Physics laboratory management for spatial aspects

Range	<i>f</i>	Category	%
91-100	0	Highly Appropriate	0
76-90	1	Appropriate	33
61-75	0	Quite Appropriate	0
51-60	2	Less Appropriate	67
0-50	0	Inappropriate	0

Based on table 5, the recapitulation of spatial aspects of physics laboratory, SMAN 18 Makassar, and SMAN 22 Makassar was in quite appropriate category and SMAN 21 Makassar is in the appropriate category. So, it can be concluded that the physics laboratory spatial aspects of the State Senior High schools at the northern area of Makassar was in the category of quite appropriate with a percentage of 33% and 67% in the medium category, which is presented in the following pie diagram:

c. The Description of management of Physics Laboratory in the aspect of Occupational Safety and Health.

Data on research results related to the management of physics laboratory for aspects of occupational safety and health (K3) can be shown in the following table:

Table 6. Recapitulation of physics laboratory management data for safety and health aspects (K3)

No	Schools	Score
1	SMAN 18 Makasar	60
2	SMAN 21 Makasar	48
3	SMAN 22 Makasar	63
Average		57

Based on the data in table 6, the description of physics laboratory management for occupational safety and health (K3) can be categorized based on the following table 7:

Table 7. Category of Physics Laboratory for Occupational Safety and Health (K3)

Range	<i>f</i>	Category	%
91-100	0	Highly Appropriate	0
76-90	0	Appropriate	0
61-75	1	Quite Appropriate	34
51-60	1	Less Appropriate	33
0-50	1	Inappropriate	33

Based on table 7, the recapitulation of occupational safety and health category of physics laboratory, SMAN 18 Makassar was in the medium category with the percentage of 33%, SMAN 21 Makassar was in Less Appropriate category with the percentage of 33% and SMAN 22 was in Quite an Appropriate category with the percentage of 33%.

DISCUSSION

The results obtained from the research of the State Senior High schools at the northern area of Makassar, related to laboratory management, showed that for the management of the spatial layout aspects of the studied schools has been in accordance with the standard of facilities and infrastructure. For the management of spatial and occupational safety (K3), only 1 out of 3 schools that were in accordance with the standards, while the other two schools were less appropriate with the standards.

Based on the results obtained it can be concluded that only in the aspect of the management of physics laboratory layout that was appropriate with the Regulation of the Ministry of National Education No.24 of 2007 (Depdiknas, 2007).

Lack of management on the spatial aspects and laboratory safety due to the lack of involvement of the school in

running the standard facilities and Infrastructure. The number of activities and works as directed in the school curriculum is one of the factors that inhibit the lack of attention from the school, in this case, the laboratory personnel to manage the laboratory effectively. In addition, a solid teaching schedule causes laboratory personnel does not have enough time to manage their laboratories.

Some of the above obstacles reinforced by the results of research by Imastuti states that the conditions of laboratory management in schools due to the absence of management personnel and the teachers are busy teaching in the class, so that laboratory management is not running optimally. In order for the laboratories' sustainability, efficiency, and utility to be maintained, the laboratory needs to be well managed; one part of the management is the staff or the laboratory personnel (Imastuti et al., 2016).

Katili adds that other inhibiting factors are the budget for equipment purchases and the replacement of damaged equipment budgeted by schools is still too small to meet the standard of facilities and infrastructure as set out in the Regulation of the Ministry of National Education no. 24 of 2007 (Katili, Sadia, & K, 2013). Therefore, there are many shortages of laboratory equipment needed in physics learning, and this problem will certainly have an impact on the less optimal of the physics learning process and also contribute to the low average of student learning outcomes.

The Regulation of the Ministry of National Education no. 24 of 2007 contain a detailed explanation of the optimal laboratory management. The rules describe the standard of school facilities and infrastructure, one of which is the physics laboratory. Based on this standard, then the school physics laboratory should be done optimally. Istiqomah added through the results of her research that for the management of physics laboratories to

be good then it needs to consider several factors, namely (1) the availability of good practicum equipment, (2) physics teacher readiness, and (3) laboratory's personnel readiness (Istiqomah & Kusumaningtyas, 2016).

The result of this research is in line with the research conducted Puspita which shows that the average quantity and quality of equipment, furniture, and physics laboratory rooms of state senior high schools in Malang is 55.2%, which is not appropriate with the Regulation of the Ministry of National Education Number 24 Year 2007 about the standard of facilities and infrastructure of high school laboratory (Puspita, Masjkur, & Muhardjito, 2016).

Based on the description, then the school should give enough attention to the management of the laboratory. This is so that the implementation of physics learning in schools can be implemented optimally. A good laboratory will certainly have a good impact on the achievement of the goals required by the curriculum.

CONCLUSIONS AND SUGGESTIONS

Based on the result of the research, it can be concluded that: (1) description of physics laboratory layout management in the State Senior High schools at the northern area of Makassar is appropriate with the standard of facilities and infrastructures of the Regulation of the Ministry of National Education Number 24 the Year 2007; (2) description of physics laboratory management in the State Senior High schools at the northern area of Makassar related to spatial layout is categorized less appropriate with the standard of facilities and infrastructures of the Ministry of National Education Number 24 Year 2007; (3) description of physics laboratory management in the State Senior High schools at the northern area of Makassar related to the Occupational Safety and Health (K3) is categorized less appropriate with the

standard of facilities and infrastructures of the Ministry of National Education Number 24 the Year 2007.

The results of this study illustrate the state of physics laboratory management in the State Senior High schools in the northern area of Makassar. They have not described the laboratory conditions in schools located in other areas of Makassar. In addition, the results of this study also focus only on the description of physics laboratories and not in chemical or biological laboratories, so that further research is needed to describe the laboratory conditions in all areas of Makassar.

ACKNOWLEDGMENT

The researchers' gratitudes belong to the relevant departments for cooperation during the research process, as well as to all parties who have provided input in this research.

REFERENCES

- Ali, M. (2015). *Analisis Kinerja Ketenagaan Laboratorium Fisika Madrasah Aliyah Kota Makassar*. UIN Alauddin Makassar.
- Anwar, E., D. (2014). Pelatihan Pembuatan Alat-Alat Praktikum IPA Fisika Bagi Guru IPA SMP/MTs Swasta Se-Kecamatan Winong Kab Pati. *Dimas Jurnal Pemikiran Agama Untuk Pemberdayaan*, 14(1), 43–56.
- Darsana, I. W., Sadia, I. W., & Tika, I. N. (2013). Analisis Standar Kebutuhan Laboratorium Kimia dalam Implementasi Kurikulum 2013 pada SMA Negeri di Kabupaten Bangli. *Jurnal Pendidikan IPA Indonesia*, 4(1), 1–10.
- Depdiknas. Permendiknas Nomor 24 tahun 2007 tentang Standar Sarana Dan Prasarana untuk Sekolah Dasar/Madrasah Ibtidaiyah (SD/MI), Sekolah Menengah Pertama/Madrasah Tsanawiyah

- (SMP/MTs), dan Sekolah Menengah Atas/Madrasah Aliyah (SMA/MA) (2007). Indonesia: Jakarta.
- Imastuti, Wiyanto, & Sugianto. (2016). Pemanfaatan Laboratorium dalam Pembelajaran Fisika SMA/MA Se-Kota Salatiga. *Unnes Physics Education Journal*, 5(3), 51–58.
- Istiqomah, H. F. N., & Kusumaningtyas, D. A. (2016). Analisis Pengelolaan Peralatan Praktikum Fisika Kelas XI SMA Muhammadiyah 1 Yogyakarta Menggunakan Model Countenance Stake. *JRKPF UAD*, 3(2), 55–62.
- Katili, N. S., Sadia, I. W., & K, S. (2013). Analisis Sarana dan Intensitas Penggunaan Laboratorium Fisika serta Kontribusinya Terhadap Hasil Belajar Siswa SMA Negeri di Kabupaten Jembrana. *E-Journal Program Pascasarjana Universitas Pendidikan Ganesha Program Studi IPA*, 3.
- Mastika, I. N., Adnyana, I. B. P., & Setiawan, I. G. N. A. (2014). Analisis Standarisasi Laboratorium Biologi dalam Proses Pembelajaran di SMA Negeri Kota Denpasar. *E-Journal Program Pascasarjana Universitas Pendidikan Ganesha Program Studi IPA*, 4.
- Novianti, N. R. (2011). Kontribusi Pengelolaan Laboratorium dan Motivasi Belajar Siswa terhadap Efektivitas Proses Pembelajaran. *Jurnal Pendidikan MIPA UPI Edisi Khusus*, 1, 158–166.
- Puspita, W. I., Masjkur, K., & Muhardjito. (2016). Analisis Pengelolaan Laboratorium Fisika SMA Negeri di Kabupaten Malang. In *Seminar Nasional Jurusan Fisika FMIPA UM* (pp. 37–42). Malang: Universitas Negeri Malang.
- Sani, R. A. (2012). *Pengembangan Laboratorium Fisika*. Medan: Unimed Press.
- Siregar, S. (2014). *Statistik Parametrik untuk Penelitian Kuantitatif*. Jakarta: Bumi Aksara.
- Subana, M., & Sudrajat. (2011). *Dasar-Dasar Penelitian Ilmiah*. Bandung: Pustaka Setia.
- Yaman. (2016). Pengoptimalan Peran Kepala Labor dalam Menunjang Pembelajaran IPA di SMPN 7 Kubung. *Jurnal Penelitian Guru Indonesia – JPGI*, 1(1), 63–71.

DETERMINING X-RAY EFFECTIVE ENERGY IN LINEAR ACCELERATOR (LINAC) RADIOTHERAPY INSTRUMENT

Fauziah*¹, Bualkar Abdullah²

^{1,2} Physics Department, Hasanuddin University Perintis Kemerdekaan Street, Km.10, Tamalanrea Indah, Tamalanrea, Makassar, North Sulawesi, Indonesia

*Correspondence address: hidayatfauziah70@gmail.com

Accepted: January 27th, 2018. Approved: April 15th, 2018. Published: April 28th, 2018

Abstract: This research in determining x-ray effective energy in linear accelerator (Linac) radiotherapy device was done using copper plates at different thicknesses by determining the Half Value Layer (HVL) for each energy. The purpose of this research is to know the amount of effective energy used in radiotherapy linear accelerator. The results showed that the energy of 6 MeV obtained 2,714 MeV of effective energy at HVL 4,500 mm and at the energy of 10 MeV obtained 4,231 MeV of effective energy at HVL 4,500 mm.

© 2018 Physics Education Department, UIN Raden Intan, Lampung.

Keywords: *copper plates, effective energy, half value layer, linear accelerator*

INTRODUCTION

Radiotherapy in the medical world is a medical instrument which existence is very important. By using radiotherapy device, treatment of cancer patients can be done without causing damage to normal tissue. the use of radiotherapy should be optimized at the target volume in regard to the effective dose received by without causing significant damage to the surrounding normal tissue (G. & Budiantari, 2005). Therefore, routine patient doses should be performed. Thus, it is expected to obtain local control, prolong life expectancy, and maintain the quality of life (Fahmi, Arif, Firdausi, & Budi, 2008).

One of the important parameters in X-rays to be controlled is the quality of the X-ray beam. The quality of the X-ray beam is expressed in the amount of Half Value Layer (HVL) or the thickness of the material, i.e. the size of the penetrating power of X-rays penetrating the material until its intensity is halved that of the original. The greater the HVL value the greater the translucency, and vice versa (Yunita, Setiawati, & Anam, 2014),

determining HVL value with a single expose is, of course very practical and efficient. However, it should be noted that a practical and efficient system is not enough. Moreover, the system must be accurate (Yunita et al., 2014).

In Indonesia, the Decree of the Minister of Health of the Republic of Indonesia number 1250, the Half Value Layer (HVL) or Partial Thickness Value is one of the parameters specified and is part of the generator testing becomes an element of the X-ray generator system. The inconsistency of production / X-ray output from the X-ray tube generated by a generator is strongly influenced by technical parameters such as tube voltage quality, current strength and time (Peraturan Pemerintah Republik Indonesia, 2009). The amount of inconsistent radiation output due to a poor performance of technical parameters directly affects the variations in the quality of the picture, the quality or quantity of radiation produced and the radiation dose that occurs. It is therefore important to monitor HVL parameters due to the increased effective energy of X-rays and indirectly improve

the performance of X-ray instrument so that the quality of radiographs in providing clear information about the objects or organs examined will be better (Yunita, Evi Choirul, 2014).

The quality of the x-ray beam is necessary to know to achieve the diagnostic purpose, which can be read and analyzed properly and accurately by the doctor and minimize the dose received by the patient (Sumarni & Mart, 2000) as, the research has been done with the title of determining x-ray effective value on the radiodiagnostic instrument, the study was conducted by measuring the effective value of radio diagnostic instrument. Given the current health check do not only rely on the radio diagnostic instrument, thus this research was done in determining the effective value by using radiotherapy instrument.

Determining the HVL or X-ray instrument can be done by using the variation of filter thickness and using X-ray multimeter tool (Palinggi, 2016). Investigated the determination of HVL values using filter thickness variation on Linear Accelerator (LINAC) instrument, the purpose of the research was to determine the HVL value of LINAC radiotherapy instrument with filter thickness variation, determine the thickness of the filter used to obtain HVL, and determine the value of the linear attenuation coefficient (μ) of the filter used, so that the HVL value of the energy of 6 MV is 3.85cm, while the HVL value of the energy of 10MV is 5.95cm. The hydroperformation of the electrode (μ) of the aluminum filter at the energy of 6 MV is 0.18cm^{-1} while the energy of 10 MV is 0.107cm^{-1} .

THEORY

Half Value Layer (HVL) is the thickness of the material required to reduce the intensity of X-rays to half of the original intensity. The advantages of using HVL are increasing the effective energy of

X-rays and indirectly improving the performance of X-ray instrument. If the effective energy of the X-ray beam increases because of the increase in effective energy due to the addition of the filter, the X-ray penetration is also increased (Sprawls, 1995).

The Half-value layer is the thickness required to absorb the radiation of its intensity to half (I_x) of the initial intensity (I_0). In general, I_x value can be written (Nurdin, 2015).

$$I_x = I_0/2$$

X-ray beam that penetrates the material, in this case, the body, will be attenuated so as to reduce the x-rays output. It can be seen in the following equation

$$I = I_0 e^{-\mu x}$$

With I as the intensity of the forwarded photon, I_0 is the intensity of the coming photon, and μ as the coefficient of linear attenuation, whereas x is the thickness of the material. All of the above variables can be measured except μ (Gabriel, 1996).

By defining the HVL value, we can obtain the relationship between HVL with linear attenuation coefficient and can be written:

$$I_x = I_0 \exp(-\mu x)$$

Where I_x is the intensity obtained after the radiation passes through the material with the thickness of x , I_0 is the initial radiation intensity and μ is the linear attenuation coefficient of the material used (Nurdin, 2015).

The linear attenuation coefficient (μ) is the smallest fraction of the intensity of the photon beam lost on each unit of material thickness, in which case cm. the value of μ is determined by the large cross section of each interaction process that occurs (Sumarni, 2008).

METHODS

Tools and Materials

1. Linear Accelerator radiotherapy instrument.
Linear Accelerator radiotherapy instrument serves as an x-ray generator.
2. Four pieces of copper filters with the thickness of 0.1mm; 0.5mm; 1mm; and 2 mm.
Copper filters are used as the test material to determine the x-ray beam of the radiotherapy instrument.
3. Survey Meter.
Survey meter serves as a detector measuring the value of exposure to radiation released by radiotherapy instrument.
4. Meter.
The meter serves as a measurement for the distance between the radiotherapy instrument to the detector.

Research Procedure

1. preparing survey meters and copper plates
2. Preparing radiotherapy instrument in ready-made condition
3. Adjusting the position of radiotherapy and survey meter instrument
4. Adjusting the voltage on the radiotherapy instrument
5. Conducting irradiation
 - a. Without using any copper filter
 - b. Using a copper filter with the thickness of 0.2cm
 - c. Using a copper filter with the thickness of 0.4cm
 - d. Using a copper filter with the thickness of 0.6cm
 - e. Using a copper filter with the thickness of 0.8cm
 - f. Recording the value obtained from each irradiation
 - g. Repeat steps a, b, c, d, and e with varying voltages
 - h. Record the results obtained

RESULTS AND DISCUSSION

In this research, the result of measurement of the average value of the count by using phantom solid water and copper plates of varying thickness was obtained.

Table 1. Measurement Results For 6 MeV Energy

Plate (mm)	Count (MeV)						Mean
	I	II	III	IV	V	VI	
0	5,54	5,51	5,55	5,41	5,52	5,53	5,51
1,00	4,10	4,12	4,13	4,10	4,12	4,11	4,11
1,50	3,87	3,82	3,79	3,84	3,74	3,86	3,82
2,50	3,55	3,60	3,64	3,56	3,54	3,55	3,57
3,00	3,01	3,13	3,10	3,02	3,16	3,03	3,08
4,50	2,79	2,64	2,70	2,78	2,65	2,70	2,71
5,15	1,45	1,52	1,48	1,47	1,50	1,48	1,48

In table 1, the result of measurement of exposure by using 6 MeV of energy and copper plates with varying thickness. From table 1, it can be seen that the value obtained was smaller if the copper plate used was thicker, this was due to the thicker the copper plates then the passing energy was also getting smaller

Table 2. Measurement Results For 10 MeV Energy

Plate (mm)	Count (MeV)						Mean
	I	II	III	IV	V	VI	
0	8,37	8,37	8,25	8,37	8,29	8,38	8,34
1,00	7,13	7,20	7,14	7,19	7,17	7,16	7,17
1,50	6,51	6,57	6,53	6,48	6,53	6,52	6,52
2,50	5,81	5,74	5,86	5,78	5,87	5,85	5,82
3,00	5,21	5,17	5,20	5,22	5,18	5,26	5,21
4,50	4,30	4,20	4,21	4,22	4,21	4,22	4,23
5,15	2,69	2,72	2,67	2,70	2,72	2,70	2,70

In table 2, the result of measurement of exposure by using 10 MeV of energy and copper plates with varying thickness. From table 1, it can be seen that the value obtained was smaller if the copper plate used was thicker, this was due to the thicker the copper plates then the passing energy was also getting smaller.

Table 3. Calculation of Energy Intensity for 6 MeV

Plate (mm)	Energy (MeV)	Intensity (W/m ²) ($\times 10^{-21}$)	Ln
No plate	5,514	2,444	-47,460
1,00	4,117	1,825	-47,752
1,50	3,824	1,694	-47,827
2,50	3,577	1,585	-47,893
3,00	3,080	1,365	-48,043
4,50	2,714	1,202	-48,170
5,15	1,489	0,660	-48,769

In table 3, we get the intensity value for each measurement at 6 MeV energy setting. This intensity value was obtained by finding the relationship between (MeV) with intensity (W / m²) for the measurement without using any copper plate hence greater energy was obtained, this was because there was no shield that blocks out the beam.

Table 4. Calculation of Energy Intensity for 10 MeV

Plate (mm)	Energy (MeV)	Intensity (W/m ²) ($\times 10^{-21}$)	Ln
0	5,514	3,699	-47,046
1,000	4,117	3,179	-47,197
1,500	3,824	2,894	-47,291
2,500	3,577	2,582	-47,405
3,000	3,080	2,310	-47,517
4,500	2,714	1,875	-47,725
5,150	1,489	1,197	-48,174

In table 4, we get the intensity value for each measurement at 10 MeV energy setting. This intensity value was obtained by finding the relationship between (MeV) with intensity (W/m²) for the measurement without using any copper plate hence greater energy was obtained, this was because there was no shield that blocks out the beam.

Comparison Charts and the thickness of the Copper Plates is shown in Figure 1 below,

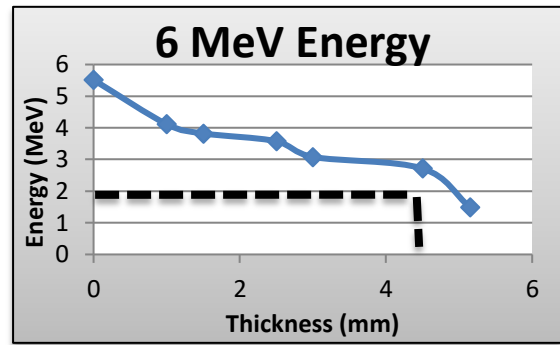
**Figure 1.** Graph of the thickness of the copper plates with the value of 6 MeV energy

The comparison graph between the copper plates' thickness with the value of 10 MeV energy is shown in Figure 2 below:

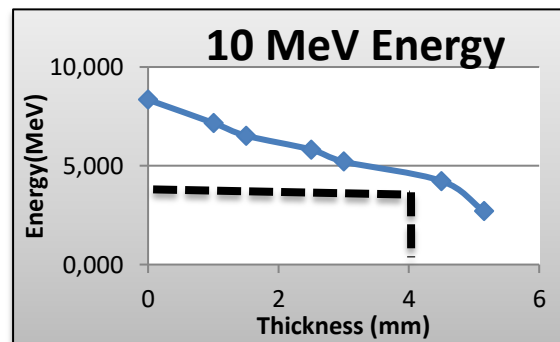
**Figure 2.** Graph of the thickness of the copper plates with the value of 10 MeV energy

Based on the result of the research, it is known that the thicker the copper plate used, the smaller the count value, the thicker the copper plate used, the greater the radiation exposure. while the measurement without any copper plate, then the amount of radiation exposure will also be greater. As the research was done by Sumarni in 2000 using the plate for determining effective energy. The same research has been done using an aluminum plate (E Ariga, Ito, Deji, Saze, & Nishizawa, 2012). Research using Pb shield on Radiotherapy instrument has also been done before that radiation shield was able to inhibit radiation beam output of the radiotherapy instrument where thickness

will inhibit the amount of radiation beam (Yuniasari, Kristiyanti, Rozali, & Syawaludin, 2013). This is because the thickness of copper plates influence the exposure to radiation out of the source. the thicker the plate used, the less exposure to radiation that can pass through the plate and vice versa. The thickness of the object affects the quality of the image obtained, the thicker the plate the smaller the intensity and it will also reduce the penetration ability (Sumarni & Mart, 2000).

In this study, the effective energy of the linear accelerator radiotherapy instrument was obtained when using a copper plate of 4.5 mm thickness with an energy of 2.714 MeV when the radiotherapy energy was at 6 MeV energy. while the radiotherapy energy was at 10 MeV, energy obtained was 4.231 MeV. So it can be concluded that for the use of two energy arrangements that is 6 MeV and 10 MeV effective energy was obtained when the copper plate with a thickness of 4.5mm was used with each energy count of 2.714 MeV and 4.231 MeV.

CONCLUSION AND SUGGESTION

Conclusion

Based on the results of the study, it can be concluded that: The effective energy of linear accelerator radiotherapy instrument using 6 MeV energy setting is 2.714 MeV while using 10 MeV energy setting the energy obtained is 4.231 MeV. the effective energy is obtained when a copper plate with 4.500 mm thickness is used.

Suggestion

Effective x-ray energy measurements on a linear accelerator radiotherapy instrument should employ more variable energy arrangements not only the two energy settings and the thickness of the plate used should be more varied.

REFERENCES

- E Ariga, S., Ito, S., Deji, T., Saze, K., & Nishizawa. (2012). Determination of Half Value Layers of X-ray equipment Using Computed Radiography Imaging Plates. *Physics Medica*, 1(1). <https://doi.org/doi:10.1016/j.ejmp.2011.01.001>
- Fahmi, Arif, K., Firdausi, S., & Budi, W. S. (2008). Pengaruh Faktor Eksposi pada Pemeriksaan Abdomen terhadap Kualitas Radiograf dan Paparan Radiasi Menggunakan Computed Radiograph, 11(4), 109–118.
- G., W., & Budiantari, C. T. (2005). Optimalisasi Aspek Keselamatan Pada Kalibrasi Pesawat Radioterapi.
- Gabriel, J. (1996). *Fisika Kedokteran*. Denpasar-Bali: Departemen Fisika Universitas Udayana.
- Nurudin, W. B. (2015). *Fisika Kedokteran Nuklir, Pusat Kajian dan Peningkatan Aktivitas Instruksional LKPP*. Makassar: Universitas Hasanuddin.
- Palinggi, Y. (2016). Penentuan Nilai Half Value Layer (HVL) Dari Plate Aluminium Dengan Metode Variasi Ketebalan Filter Menggunakan Pesawat Linear Accelerator (LINAC). In *Universitas Hasanuddin*. Makassar: Universitas Hasanuddin.
- Peraturan Pemerintah Republik Indonesia. Keputusan Menteri Kesehatan Republik Indonesia Nomor 1250/MENKES/SK/XIII/2009 Tentang Pedoman Kendali Mutu (Quality Control) Peralatan Radiodiagnostik, Pub. L. No. 13 (2009). Indonesia.
- Sprawls, P. (1995). *Physical Principles of Medical Imaging* (2nd ed.). USA: Aspen Publisher.
- Sumarni. (2008). Pusat Pendidikan dan Pelatihan Badan Tenaga Nuklir Nasional. In *Deteksi dan Pengukuran Radiasi*. Jakarta: Pusdiklat-BATAN.
- Sumarni, T., & Mart, N. (2000). Energi

- Efektif Sinar-X Radiodiagnostik. In *Puslitbang Keselamatan Radiasi dan Biomedik Nuklir*. Batan.
- Yuniasari, L., Kristiyanti, B., Rozali, B., & Syawaludin. (2013). Perancangan Perisai Radiasi pada Kepala Sumber untuk Pesawat Radioterapi Eksternal Menggunakan ^{60}Co pada Posisi beam off. *Pusat Rekayasa Perangkat Nuklir (PRPN)*, 7.
- Yunita, H. D., Setiawati, E., & Anam, C. (2014). Evaluation Method Determination Half Value Layer (HVL) Using Multi Purpose Detector (MPD) Barracuda Sinar-X Mobile, 3(2), 113–118.

CHARACTERIZATION OF ACTIVE CARBON PREPARED FROM COCONUTS SHELLS USING FTIR, XRD AND SEM TECHNIQUES

Andi IkhtiarBakti*¹, Paulus Lobo Gareso²

^{1,2}Departement of Physics, Faculty of Mathematics and Natural Sciences, Universitas Hasanuddin, Makassar-South Sulawesi, Indonesia

*Correspondence address: andiikhtiar@yahoo

Accepted: October 25th, 2017. Approved: February 2th, 2018. Published: April 24th, 2018

Abstract: Activated carbon is produced from coconut shells through physical and chemical activation. With pyrolysis method, the optimum activation temperature for physics activation is 600°C, and for chemical, activation is to soak it in activator ZnCl₂ 10% and Na₂Ca₃ 10%. Activated carbon was analyzed by Fourier Transformation Infrared (FTIR) and X-ray Diffraction (XRD) methods. The FTIR result showed that the coconut shells succeeds in becoming carbon. The XRD results confirm the existence of several phases of crystals like graphite around the peaks of 36° and 44°, there are two wide diffraction peaks and can be interconnected with carbon and graphite content. The SEM result showed that the carbonization of pyrolysis and activation processes created porosity and a large surface area for absorption.

© 2018 Physics Education, UIN Raden Intan, Lampung, Indonesia.

Keywords: activated carbon, coconut shell, FTIR, SEM, XRD

INTRODUCTION

Coconut shell as a raw material is often converted into activated carbon (Arami-Niya, Daud, Mjalli, Abnisa, & Shafeeyan, 2012). Based on data obtained, Southeast Asia was a region with a considerable amount of coconut production with four countries as its main producers; India, Indonesia, Philippines, and Sri Lanka contributing 78% of coconut production in the world (Rao, A.H.L.Swaroop, Rao, & Bharath, 2015). In regard to the production of the activated carbon, Indonesia is currently one of the main exporter countries of activated carbon (Cocommunity, 2016).

Activated carbon has been known as the most effective and useful adsorbent for removing pollutants from contaminated gas and liquid flow. This is due to the fact that the activated carbon has a large active surface area which can provide a well-developed porous structure of absorption capacity and good mechanical properties (Hidayu, 2016). The fundamental for producing activated carbon was carbon-rich organic material (A.R Hidayu, 2016).

The development of methods of reusing waste materials as activated carbon was expected to be a solution in waste utilization, such as jatropha seed, corncobs, coconut shell, palm fiber and sawdust, which proves very good to be converted into activated carbon because of its hard texture and strength due to the high lignin and carbon content and low ash levels of these materials (Lehmann & Joseph, 2009; Promdee et al., 2017; Rao et al., 2015).

The process of producing activated carbon from coconut shell consists of pyrolysis method, turning coconut shell into charcoal, then activation process. The activation process was divided into two, namely physical activation and chemical activation. The process of physical activation is obtained by carbonization with an oxidizing gas or carbon dioxide in high temperatures (400-1000°C), while chemical activation was immersed it in the chemical solutions of a certain concentration such as ZnCl₂, Na₂CO₃, KOH, and KCl (Hung, 2012). Activated carbon produces better carbon crystal

structures and amorphous structures that are stacked irregularly by carbon rings that are useful for producing an adsorbed gap, with 97% pure carbon (Pradhan, 2011; Rani, Mohammad, Matali, & Kadir, 2014).

The activation process is carried out by mixing the initial material with the activation reagent and afterward heating it under the inert atmospheric pressure (A.R Hidayu, 2016). This process was usually performed at lower temperatures and times compared to the process of physical activation. The surface area and the resulting porosity are better than the activation. Therefore, this research used the coconut shell as the main ingredient in making activated carbon considering its abundant material in Indonesia and very affordable market value.

METHODS

Raw Material

Coconut shell (CS) was selected for the manufacture of activated carbon. The material was cleaned with aquades several times to remove dust and dirt. The coconut

shell sample was then dried in the oven at 110°C for 24 hours to remove surface moisture and then milled to the desired size. Then an analysis was performed to find out the volatile and carbon content as well as to measure the composition of each element. This method is similar to the previous research method (Hidayu, Muhammad, Matali, & Sharifah, 2013).

Activated Carbon

The coconut shell was activated using physical activation by being fed into a pyrolysis reactor which was heated to a temperature of 600°C and it was stored for an hour. The activated carbon was immersed in ZnCl₂ 10% and Na₂CO₃ 10% then stored for 24 hours at room temperature. After the activation process was complete, activated carbon was then cleaned with aquades and dried using an oven at 100° C for thirty minutes. After that, the activated carbon was sieved using ASTM Standard. The Test Sieving has a size of 70-200 Mesh. The sieve model used consists of three sieve arrangements.

RESULT AND DISCUSSION

FTIR Analysis

Table 1. The major wavenumber in regards to the chemical bonding compound value of FTIR spectra of ZnCl₂ and Na₂CO₃ (Fan, Dai, & Huang, 2012).

Wave number (cm ⁻¹)	Assignments	ZnCl ₂	Na ₂ CO ₃
3500-3300	O-H Stretching (intermolecular hydrogen bonded)		
2930-2900	C-H Asym. Stretching	*	*
2720	C-H (aldehydes)		
1740	C=O stretching in esters		
1625-1610	C=C Aromatic skeletal stretching		
1580-1570	C=C stretching band	*	*
1450-1420	C-H Asymmetric. Bending		
1375-1317	C-H Asymmetric. And symmetric. bending		
1284-1240	C-O Asymmetric. stretching of aromatic ethers, esters, and phenols		
1260-1000	C-O in carboxylic acids, alcohols, phenols and esters or the P=O bond in phosphate esters	*	*
700-400	C-C stretching	*	*

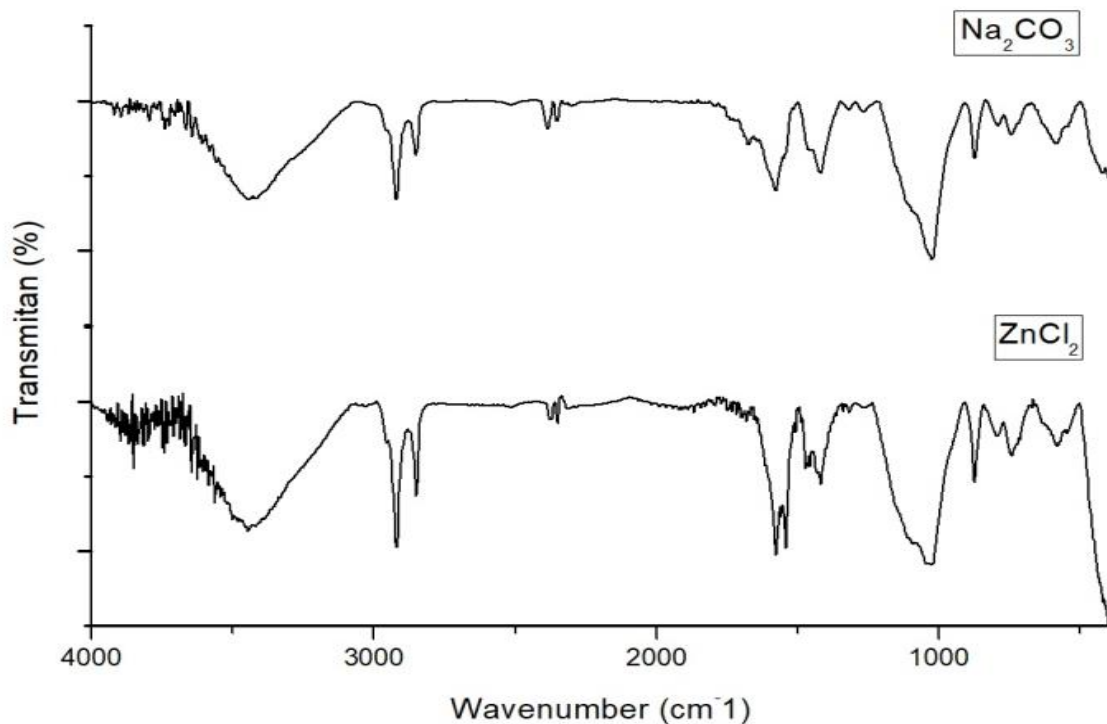

Figure 1. FTIR of activated carbon of ZnCl_2 and Na_2CO_3

FTIR spectra of the activated carbon of the ZnCl_2 AND Na_2CO_3 samples, respectively. FTIR spectra contained vast and strong bands at $3200\text{-}3500\text{ cm}^{-1}$ for hydroxyl (O-H) stretching vibration groups. The structure contains many carbons bonds which also act as a remover of hydrogen, and the oxygen atoms of that frequency may contain stretching of amines (NH_2) and alcohol (OH) groups lost during the activation to 600°C . This indicates the dehydration of cellulose and lignin components (Shilpi, 2012). Meanwhile, the absorption peak at $2900\text{-}2850\text{ cm}^{-1}$ for the stretching vibration (CH) of the (-CH) 3 group is completely removed from the activated carbon sample. The carbonyl group ($\text{C}=\text{O}$) was observed in samples ZnCl_2 and Na_2CO_3 in $1740\text{-}1700\text{ cm}^{-1}$ is expected to come from the lignin network. However, this peak is virtually non-existent after pyrolysis and the immersion activation process with ZnCl_2 and Na_2CO_3 because it is volatile. Peaks ranging from $1200\text{-}1000\text{ cm}^{-1}$ show the presence of stretching (C-O) and 830

cm^{-1} (Si-O) as the result of silica containing minerals (Hidayu, Muhammad, Matali, & Sharifah, 2013; Rani, Mohammad, Matali, & Kadir, 2014). The FTIR spectra have confirmed that activated carbon has been successfully converted into carbon (NB, N, & Y, 2016). For activated carbon, clear during the hardening and activation process, most of the functional group adsorption peak is lost. Because the functional groups of the spectrum feedstock are evaporated as volatile materials when heat is supplied to the sample. This proves that the activation process has been successfully performed and the carbon retains some functional group of sensitive IR, functional group (C-O) (Hesas, Arami-Niya, Daud, & Sahu, 2013).

Analysis XRD

Spectrum X-ray diffraction pattern of the activated carbon of ZnCl_2 and Na_2CO_3 samples. The diffraction peaks are observed at the diffraction angle of $2\theta =$

29,5°, 34,6° and 39,4° respectively which corresponds to silicate minerals, iron ore, and quartz. While the rest of the other peaks that are observed at the diffraction angle of 44.5° corresponding to sodalite, analcime and sodium silicate, respectively (Pradhan, 2011). The two active carbon samples showed two broad diffraction peaks located at $2\theta = 30^\circ\text{-}40^\circ$

and $40^\circ\text{-}50^\circ$ which revealed an amorphous structure that was irregularly stacked by carbon rings and useful for generating an adsorbed gap.

For uncarry Carbon, a sharp peak observed at 44,5° may be due to the presence of Zn and Na used during the carbon activation process (A.R Hidayu, 2016).

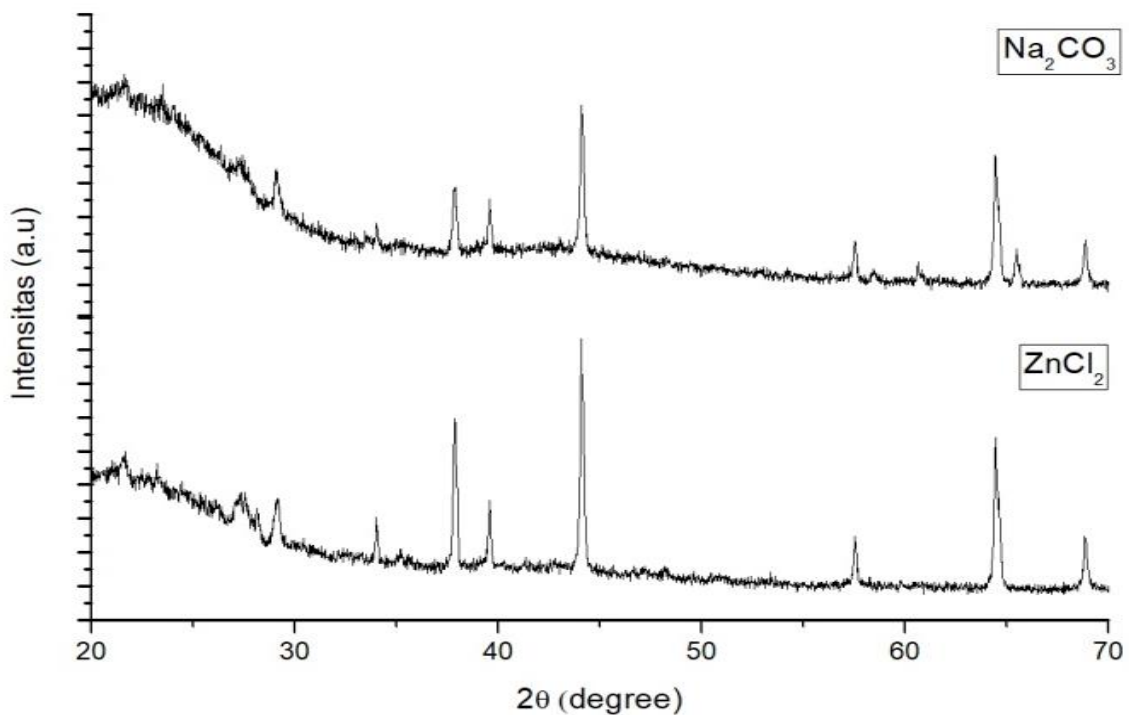

Figure 2. XRD activated carbon of ZnCl_2 and Na_2CO_3

The findings are in accordance with previous studies by Kushwaha et al., and Rani et al. (Kushwaha, Padmaja, & Sreelatha, 2012). Samples contain two broad diffraction peaks and can be attributed to the presence of carbon and graphite (Matali, Khairuddin, Sharifah, & Hidayu, 2013).

SEM Analysis

Scanning electron microscopy (SEM) was used to observe the surface physical morphology of the samples. Figure 3 shows the SEM images of the

microstructure of the raw ZnCl_2 and Na_2CO_3 . Images of the show that the activation stage produced an extensive external surface with quite and pores.

The surface topology differed strongly between raw coconut shell and active carbon physical and chemical (Roosbeh, 2013). Very high porosity was observed on the external surface of the ZnCl_2 and Na_2CO_3 . SEM morphology shows that visible pores were seen in samples of ZnCl_2 and Na_2CO_3 , apparent pores indicating activated carbon processes were successful.

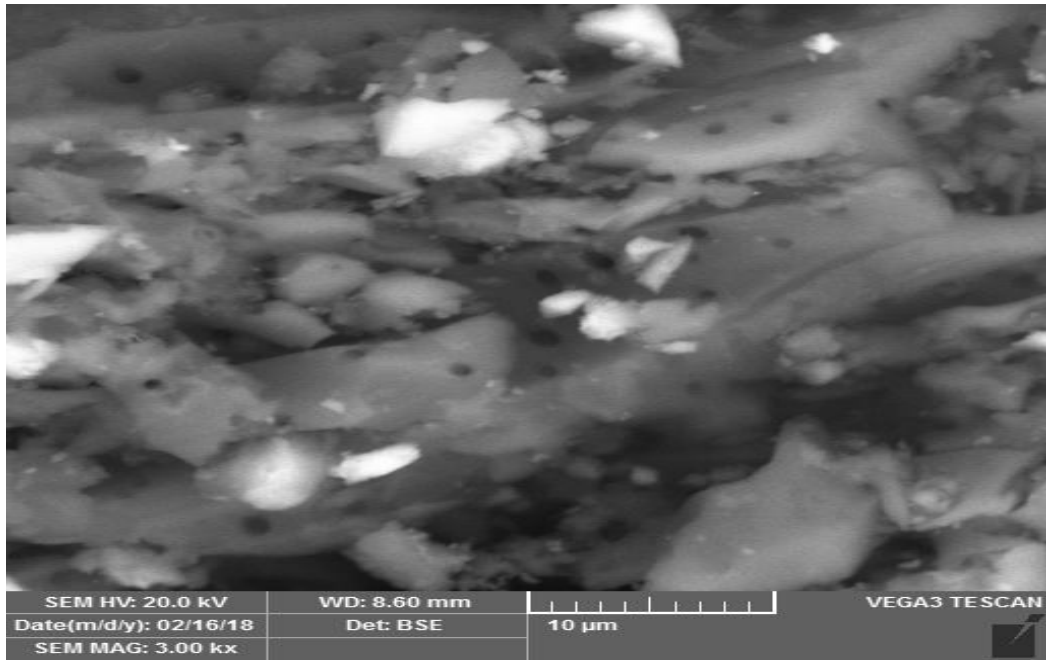

(a)

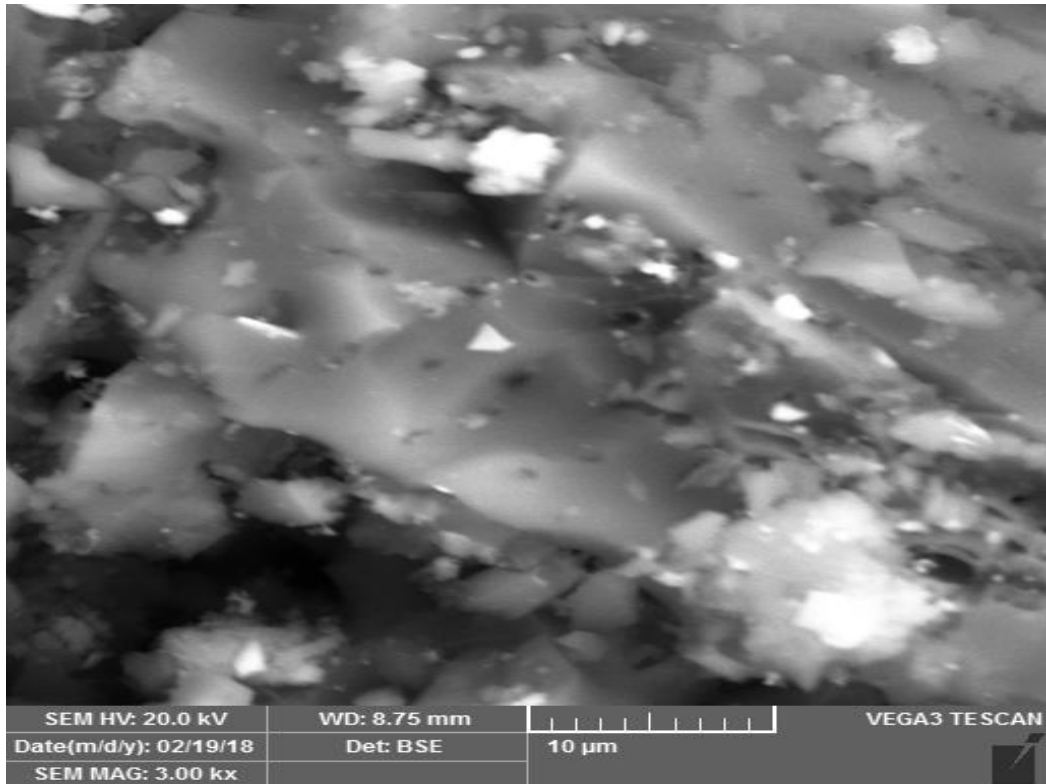

(b)

Figure 3. Morphology on the surface of activated carbon magnification of 3000x (a) Na_2CO_3 (b) ZnCl_2

CONCLUSION

Activated carbon was produced from coconut shell through physics activation of 600°C and chemical activation by immersing it in 10% ZnCl₂ activating agent. Activated carbon was analyzed by Fourier Transformation Spectroscopy Infrared (FTIR) and X-ray Diffraction (XRD) methods.

FTIR results show that functional groups of spectrum raw materials were evaporated as volatile materials when the heat was supplied to samples and immersion activation processes with ZnCl₂. This proves that the activation process has been successfully performed and the carbon retains some functional IR functional groups, functional groups (C-O) until the coconut shell was successfully converted to carbon. The XRD results confirm the presence of several phases of crystals (graphite) around peaks of 36° and 44°, with two broad diffraction peaks and can be attributed to the presence of carbon and graphite. For non-transported carbon, a sharp peak observed was at 44.5°. It might be due to the presence of Zn and Na used during the carbon activation. In conclusion, coconut shell can be utilized as cheap and efficient raw material for the production of activated carbon with very promising commercial value. The SEM-EDS results showed that the carbonization of pyrolysis and activation processes creates porosity and large surface area for absorption, where the pores of the coconut shells and the husk are still visible, in contrast to CA8 and CAZ activated carbon that showed the pores that indicate activated carbon process was successful.

REFERENCES

- A.R Hidayu, N. M. (2016). Preparation and characterization of impregnated activated carbon from palm kernel shell coconut shell for CO₂ capture. *Procedia Engineering* 148, 106–113.
- Arami-Niya, A., Daud, W. M. A. W., Mjalli, F. S., Abnisa, F., & Shafeeyan, M. S. (2012). Production of microporous palm shell based activated carbon for methane adsorption: modeling and optimization using response surface methodology. *Chemical Engineering Research and Design*, 776–784.
- Cocommunity, T. (2016). Initiatives Towards Product Diversification Seek Out Viable Opportunities in the Coconut Industry. *Monthly Newsletter of the Asian and Pacific Coconut Community*, XLVI(8), 1–32.
- Fan, M., Dai, D., & Huang, B. (2012). *Fourier Transform Infrared Spectroscopy for Natural Fibers*. Retrieved from www.intechopen.com
- Hesas, R. H., Arami-Niya, A., Daud, W. M. A. W., & Sahu, J. N. (2013). Preparation and Characterization of Activated Carbon from Apple Waste by Microwave-Assisted Phosphoric Acid Activation: Application in Methylene Blue Adsorption. *Bio Resources*, 8(2), 2950–2966.
- Hidayu, A. ., Muhammad, N. F., Matali, S., & Sharifah, A. S. . (2013). Characterization of activated carbon prepared from oil palm empty fruit bunch using BET and FTIR techniques. *Procedia Engineering* 68, 379–384.
- Hung, J. J. (2012). *The Production of Activated carbon from Coconut Shells Using Pyrolysis and Fluidized Bed Reactors*. Arizona: The University of Arizona.
- Kushwaha, S., Padmaja, P., & Sreelatha,

- G. (2012). *Physical and Chemical Modified Forms of Palm Shell Preparation, Characterization, and Preliminary Assessment*. Retrieved from <https://www.research.net/publication/257594337>, 1-17
- Lehmann, J., & Joseph, S. (2009). Biocha for environmental management. *Earthscan*.
- Matali, S., Khairuddin, S. A., Sharifah, A. S. A. K., & Hidayu, A. R. (2013). Removal of Selected Gaseous Effluent Using Activated Carbon Derived from Oil Palm Waste: An Overview. *IEEE Symposium on Business, Engineering, and Industrial Applications*.
- NB, O., N, S., & Y, U. (2016). The activated carbon of Oil Palm Empty Fruit (EFB); Core and Shaggy. *Procedia Engineering 148*, 758–764.
- Pradhan, S. (2011). *Production and characterization of Activated Carbon produced a suitable Industrial sludge*. Odisha, India: Department of Chemical Engineering National Institute of Technology Rourkela.
- Promdee, K., Chanvidhwatanakit, J., Satitkune, S., Boonmee, C., Kawichai, T., Jarernprasert, S., & Vitidsant, T. (2017). Characterization of Carbon Materials and Differences from Activated Carbon Particle (ACP) and Coal Briquettes Product (CBP) Derived From Coconut Shell Via Rotary Kiln. *Renewable and Sustainable Energy Reviews 75*, 1175–1186.
- Rani, N. H. A., Mohammad, nor F., Matali, S., & Kadir, S. A. S. A. (2014). Preparation and characterization of activated carbon made from oil palm empty fruit bunch. *Engineering Materials*, 594–595.
- Rao, K. V., A.H.L.Swaroop, Rao, D. P. K. R., & Bharath, C. N. (2015). Study on Strength Properties of Coconut Shell Concrete. *International Journal of Civil Engineering and Technology (IJCIET)*, 42–61.

THE RELATIONSHIP BETWEEN VERBAL ABILITY AND CRITICAL THINKING SKILL: THE IMPLEMENTATION OF SUSAN LOUCKS HORSLEY MODEL

Ana Yuniasti Retno Wulandari ^{*1}, Nurhayati ²

^{1,2} University of Trunojoyo Madura

*Correspondence address: ana.wulandari@trunojoyo.ac.id

Accepted: January 25th, 2018. Approved: April 12nd, 2018. Published: April 28th, 2018

Abstract: Susan Loucks Horsley is a learning model that can connect science and technology. This model can help students adapt to the increasingly changing scientific and technology of the 21st century. Students are challenged with issues that require the use of scientific information, technology, verbal ability, critical thinking, and conceptual understanding in making decisions. It is because verbal ability and critical thinking are needed in solving problems hence this research aims to know the correlation of verbal ability with students' critical thinking skill in science learning of vibration, wave and sound material using Susan Loucks Horsley model. The sample of this research is the students of VIII A SMP N 1 Pamekasan. The collecting data technique use tests to measure the students' verbal ability and critical thinking skills. The data analysis uses Pearson correlation. The result of this research shows there is a correlation between verbal ability with students' critical thinking skill in science learning of vibration, wave and sound material using Susan Loucks Horsley model with the value of Pearson correlation coefficient 0,656 and significance 0.000. This research has an implication that the teachers should be appropriate in applying the learning model that can grow the students' verbal ability and critical thinking skill.

© 2018 Physics Education, UIN Raden Intan, Lampung, Indonesia.

Keywords: conceptual understanding, critical thinking, Susan Loucks Horsley, verbal ability

INTRODUCTION

Conceptual understanding is necessary for the study of physical science. This is because conceptual understanding becomes the basis for thinking in solving various problems (Irwandani & Rofiah, 2015). Students can transfer an explanation of a phenomenon to different situations (Kola, 2017).

However, students' conceptual understanding of physical science in Indonesia is still categorized as low (Adilah & Pujayanto, 2015). Students still have problems to understand the concepts of physics that have been studied (Saleh, 2011). Lack of students conceptual understanding leads to difficulty in solving problems (Holme, Luxford, & Brandriet, 2015). Students difficulties mostly arise from the problem of understanding the word, the difficulty of making plans and

defining related vocabulary (Seifi, Haghverdi, & Azizmohamadi, 2012).

Vibration, wave, and sound are one of the eighth-grade science materials in junior high school. To learn about the concept of vibrational, waves and sounds material requires the understanding of some terms, symbols, formulas, and images. Therefore, good verbal ability needs to be owned by students (Vukovic & Lesaux, 2013).

Verbal ability is the ability that includes understanding vocabulary, verbal analogy, and others (Vukovic & Lesaux, 2013; Walgito, 2010). Verbal ability is usually demonstrated as the ability to write and speak well (Andrew, Cobb, & Giampietro, 2005). A good verbal ability can help the student in understanding the material, interpreting the questions quite complex and drawing conclusions (Daniyati & Sugiman, 2015).

Therefore, required a learning model that can facilitate students in understanding the concept and train students' verbal ability. Susan Loucks Horsley is a learning model that can connect between science and technology, involves the process of analysis, and train students to compile answers from various sources of information that will be delivered based on related questions (Liliawati, Utama, & Fauziah, 2016). Susan Loucks Horsley's model consists of four learning stages: invited, explore and discover, purpose explanation, taking action (Loucks-Horsley, Stiles, Mundry, Love, & Hewson, 2010; Muiz, Wilujeng, Jumadi, & Senam, 2016; Nurhayati, Jumadi, Wilujeng, & Senam, 2017).

Susan Loucks Horsley's model is also expected to grow students' critical thinking skills (Jumadi, Paidi, Atiarani, & Siwi, 2014). Critical thinking skills are needed to analyze and solve a problem in everyday life (Wulandari, 2017). Critical thinking is thinking that makes sense and focused reflection to decide what should be believed or done (Fisher, 2014).

When doing critical thinking tests, students must be able to understand the meaning of the test question. To understand the meaning of the problem required students' verbal skills. Therefore, students' verbal ability related to students' critical thinking skills in solving problems. James & Adewale suggests that there is a relationship between verbal ability with problem-solving abilities (James & Adewale, 2012). If students misunderstand the meaning of the question will make the students wrong in determining the problem-solving strategy so that the results obtained are also wrong (Daniyati & Sugiman, 2015).

To achieve a good learning outcome, students must have a good verbal ability (Olatoye & Aderogba, 2011). The research result of Nurbaeti, et.al shows that there is a relationship between critical thinking skills positively with students' cognitive

abilities on the subjects of Chemistry class X SMKN 1 Bungku Tengah (Nurbaeti, Nuryanti & Puspitasari, 2015). It is similar to the Adeyemi's research that in Nigeria, student learning outcomes increase significantly when teachers use learning that trains students' critical thinking skills (Adeyemi, 2012).

Based on the results of relevant research above is known that the verbal ability and critical thinking skills are closely related to learning outcomes. Therefore, this research aims to know the relationship between students' verbal ability and critical thinking skills in vibration, wave, and sound concepts.

METHODS

This research uses pre-experimental design type one-shot case study. The sample of this research is thirty students of VIII A SMP N 1 Pamekasan. The sampling technique uses purposive sampling. Purposive sampling is a technique to choose the sample with a specific purpose (Creswell, 2014).

The collecting data technique use test to measure the students' verbal ability and critical thinking skill. The verbal ability test instrument consists of 20 questions adapted from Raven and includes vocabulary tests, synonym tests, opponent tests, and verbal analogy tests (Raven, Court, & Raven, 1977; Widhiarso & Haryanto, 2015; Yazdi, 2017). The critical thinking skills test instrument consists of 10 essay questions compiled using Ennis's critical thinking indicator: simple explanation, further explanation, inference and set the strategy and tactics (Ennis, 1996; Mabruroh & Suhandi, 2017).

Before the instrument is used, it is validated to 3 experts i.e 2 lecturers and 1 science teacher. Instrument validity is calculated using the Aiken V formula as in Equation 1 (Aiken, 1985; Azwar, 2015).

$$V = \frac{\sum S}{[n(c-1)]} \quad (1)$$

Notes:

V = Validity of Aiken's V content

S = r - lo

r = The number given by validators

lo = The lowest validity score

c = Highest validity score

n = Number of validators

While the reliability of the instrument is calculated using the Borich formula as in Equation 2 (Borich, 1994).

$$R = \left[1 - \frac{A-B}{A+B} \right] \times 100\% \quad (2)$$

Notes:

R = Borich's Reliability

A = The highest frequency provided by the validator

B = The lowest frequency provided by the validator

The result of validity calculation is 1.21 and valid to use (Azwar, 2015). While the reliability results obtained value 88,5% and very reliable (Borich, 1994).

Normality and homogeneity tests are performed before hypothesis testing. Normality test using Kolmogorov-Smirnov and homogeneity test using Levene test in SPSS 20 application. The hypothesis test uses Pearson correlation in SPSS 20 application to analyze the relationship between students' verbal ability and critical thinking skill in vibration, wave, and sound material.

The data of students' verbal ability and critical thinking skill that have been collected are then categorized using criteria in Table 1 (Firdaus, Kailani, Bakar, & Bakry, 2015).

Table 1. The range of score in verbal ability and critical thinking

The range of Score %	Levels of students' verbal ability and critical thinking
X ≥ 80	Excellent
60 ≤ X < 80	Good
40 ≤ X < 60	Fair
20 ≤ X < 40	Poor
X < 20	Very Poor

RESULTS AND DISCUSSION

Implementation of the learning model of Susan Loucks Horsley conducted for 3 meetings. The first meeting to learn the concept of vibration, the second meeting to learn the concept of the wave, and the third meeting to learn the concept of sound. After that, a test is done to measure the students' verbal ability and critical thinking skills.

Some examples of students' answers to the verbal ability test can be seen in Figures 1 and 2. While the sample of students' answers to critical thinking test can be seen in Figures 3 and 4.

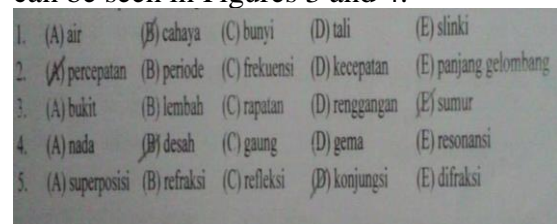

Figure 1. The students' answers to the vocabulary test

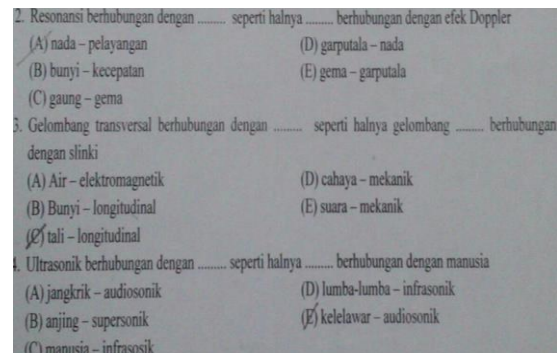

Figure 2. The students' answers to the verbal analogy test

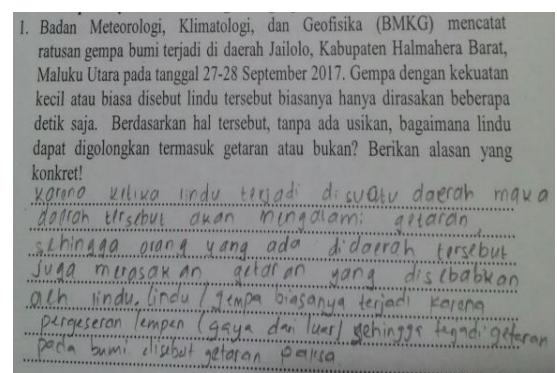

Figure 3. The students' answer to the critical thinking test in simple explanation indicator

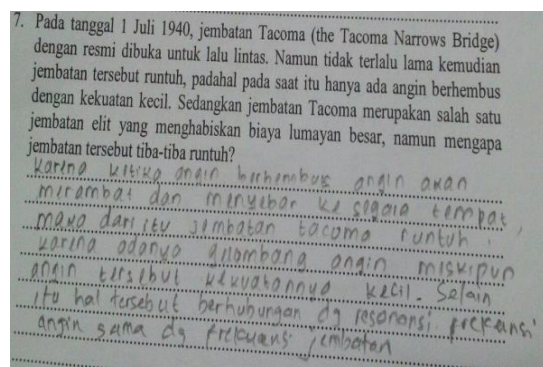

Figure 4. The students' answer to the critical thinking test in inference indicator

Figure 1 shows the students' work on vocabulary tests of verbal skills. In this vocabulary test, there are still some students who are wrong in answering questions 4. Figure 2 shows students' work results on a verbal analogy test. In this verbal analogy test, almost all students are correct in answering. Figure 3 is an example of the student's work on a critical thinking test with an indicator of simple explanation. On this question, most students answer the question correctly to explain small earthquake events. Figure 4 shows the result of the student's critical thinking test on the inference indicator. On the question, there are still some students who have difficulty inferring the cause of the collapse of the Tacoma bridge.

The data of students' verbal ability and critical thinking skill that have been collected are then categorized. The results categorization of students' verbal ability and critical thinking skill can be seen in Table 2.

Table 2. Level of students' verbal ability and critical thinking

Category	Verbal Ability		Critical thinking	
	F	(%)	F	(%)
excellent	19	63,3	23	76,7
good	11	36,7	7	23,3
fair	0	0	0	0
poor	0	0	0	0
very poor	0	0	0	0

Based on Table 2 it can be seen that 19 students have excellent category in verbal ability (63,3%) and 11 students have good category in verbal ability (36,7%). For the results of critical thinking skills, it is known that 23 students have critical thinking skills of the excellent category (76,7%) and 7 students have critical thinking skills of the good category (23,3%). None of the students are in the fair, poor, and very poor category of critical thinking skill and verbal ability. It is because in the second and third stages of Susan Loucks Horsley's model allows activities that can train students' critical thinking skills. While in the fourth stage can stimulate students' verbal ability through communication activities (Muiz et al., 2016).

In the first stage of Susan Loucks Horsley model (Invited stage), teachers provide motivation and ask questions related to the material to be studied. In the second stage of Susan Loucks Horsley model (Explore and discover stage), students are given the opportunity to gather information and even analyze the phenomenon of the problem being faced. It is related to students' critical thinking skills. Students can develop students' critical thinking in the second stage of Susan Loucks Horsley model. Students can practice critical thinking skills through scientific activities that must be done. In the third stage of Susan Loucks Horsley model (Purpose explanation stage), students are given the opportunity to present the findings using their own language. This is related to students' verbal ability. Students can practice verbal ability by communicating the findings and providing the further explanation by linking the previously learned concepts. The vibration, waves, and sound material are a matter related to everyday life. This is related to the last stage of Susan Loucks Horsley model (Taking action stage). At the last stage, students can look for examples of the application of the concept

of vibration, wave, and sound in everyday life (Loucks-Horsley et al., 2010; Muiz et al., 2016; Nurhayati et al., 2017).

To see clearly the categorization results of students' verbal ability and critical thinking skill, presented in the histogram in Figure 5.

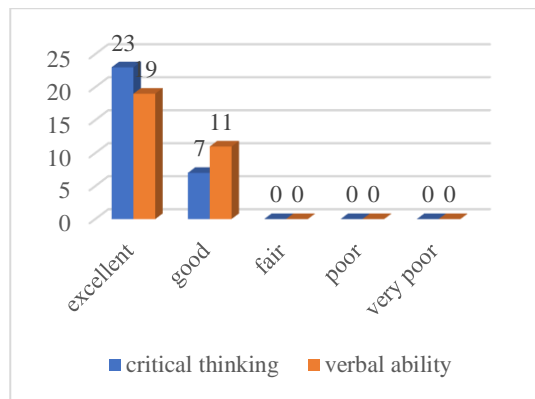

Figure 5. Students' verbal ability and critical thinking skill in learning physics

According to McCormack & Yager, Susan Loucks-Horsley model is an extension of five domains (knowledge, science process skills, creativity, attitudinal, as well as the application and connection) in science education that does not just develop content and process (McCormack, 1992). The research result of Liliawati, et.al shows that integrated learning with model Susan Loucks-Horsley is able to increase students' achievement (Liliawati et al., 2016).

The statistical descriptive results of verbal ability and critical thinking on vibration, wave, and sound material are presented in Table 3.

Table 3. Level of students' verbal ability and critical thinking

	Verbal Ability	Critical Thinking
Mean	80,17	83,25
Median	80,00	83,75
Mode	80,00	80,00
Std. Deviation	8,85	7,11
Variance	78,42	50,49
Minimum	65,00	67,50
Maximum	95,00	95,00
Sum	2405,00	2497,50

Based on Table 3 it is known that the average of verbal ability is 80,17 with the standard deviation of 8,85 and the minimum value is 65,00 and the maximum value is 95,00. The average of critical thinking is 83,25 with the standard deviation of 7,11 and the minimum value 67,50 and the maximum value 95,00. So, it can conclude that the average of verbal ability and critical thinking are an excellent level. This means that learning with the Susan Loucks Horsley model can train students' verbal ability and critical thinking skills.

This result is similar to some previous research. Based on Muiz's Research is known that the implementation of science learning through the application of Susan Loucks-Horsley model can improve communication and collaboration of learners (Muiz et al., 2016). Likewise, the application of Susan Loucks Horsley learning model can improve students learning outcomes (Anjani & Suyatno, 2015).

Before hypothesis testing, normality and homogeneity tests were performed. The normality test uses Kolmogorov-Smirnov test in SPSS 20 application. The result of the normality test is presented in Table 4.

Table 4. Test of normality

	Kolmogorov-Smirnov		
	Statistic	df	Sig.
Verbal ability	0,126	30	0,200
Critical thinking	0,125	30	0,200

Based on Table 4 it can be seen that the data of verbal ability and critical thinking are normally distributed. This is indicated because the significance of normality test is greater than 0.05, i.e the significance of verbal ability is 0.200 and the significance of critical thinking is 0.200.

The homogeneity test uses Levene test in SPSS 20 application. The result of the homogeneity test is presented in Table 5.

Table 5. Test of homogeneity

	Levene Statistic	Sig.
Based on Mean	0.814	0.371
Based on Median	0.754	0.389
Based on Median and with adjusted df	0.754	0.389
Based on trimmed mean	0.820	0.369

Based on table 5 it is known that the data is homogeneous. This can be seen from the significance of homogeneity test is greater than 0.05, which is 0.371.

The statistic used to test the research hypothesis is Pearson correlation because the data of verbal ability and critical thinking are normally distributed and homogenous. The hypothesis in this research is H_0 (there is no correlation between students' verbal ability and critical thinking skill on Susan Loucks Horsley learning model of vibration, waves, and sound material) and H_1 (there is a correlation between students' verbal ability and critical thinking skill on Susan Loucks Horsley learning model of vibration, waves, and sound material). The result of Pearson correlation SPSS 20 application is presented in Table 6.

Table 6. Pearson Correlation

		critical thinking	verbal ability
critical thinking	Pearson Correlation	1	0,656**
	Sig. (2-tailed)	.	0,000
	N	30	30
verbal ability	Pearson Correlation	0,656**	1
	Sig. (2-tailed)	0,000	.
	N	30	30

Based on Table 6 it is known that the significance of Pearson correlation between students' verbal ability and

critical thinking is 0,000 with correlation coefficient 0,656. Due to the significance of $0.000 < 0.05$ then H_0 is rejected. So, it can be concluded there is a correlation between students' verbal ability and critical thinking skill on Susan Loucks Horsley learning model of vibration, waves, and sound material. The correlation can be seen that the higher result of students' verbal ability then the students' critical thinking is also getting better. It is similar to the Irawan's research that there is an influence of verbal ability on students' critical thinking (Irawan, 2016). Students need critical thinking skills to translate the verbal statement of the problems encountered so as to solve the problem well (Awofala, 2014).

In solving the problem of critical thinking is also influenced by the students' verbal ability. Students who have high verbal ability can easily understand the intent of the problem, analyze and communicate the answers in written form (James & Adewale, 2012). Verbal ability is the ability of students in pouring knowledge and experience possessed in the form of adequate language, so that can be communicated to others (Vukovic & Lesaux, 2013). While, critical thinking is defined as a high level of ability that drives or regulates an individual to be able to think using logic, to prove an argument by way of thinking, and to evaluate opinions rationally (Nasrun, 2014). Critical thinking can be used in the formation of student conceptual systems (Purnamawati, Ertikanto, & Suyatna, 2017).

The result of this research is similar to the research of James & Adewale by concluding that there is a relationship of verbal ability with problem-solving abilities (James & Adewale, 2012). It is according to Elliott because the first and most basic step in problem-solving is to represent the information in either symbolic or diagrammatic form. While (Elliott, Kratochwill, Cook, & Travers, 1996), critical thinking involves the ability

to evaluate problems so that good conclusion can be drawn (Burke, Sears, Kraus, & Cady, 2014). Therefore, verbal ability and critical thinking skills need to be owned by students.

CONCLUSIONS

The result of this research shows there is a correlation between students' verbal ability toward critical thinking skill with Pearson correlation coefficient 0,656 and significance 0,000. The correlation can be seen that the higher result of students' verbal ability then the students' critical thinking skill is also getting better.

This research has an implication that the teachers should be appropriate in applying the learning model that can grow the students' verbal ability and critical thinking skill. The limitation of this research is to use only one class of experiments and the measurement of verbal and critical thinking tests is only done at the end of the lesson. Future researchers are needed to explore the contribution of Susan Loucks Horsley model on students' critical thinking skills and verbal ability using experiment and control class.

REFERENCES

- Adeyemi, S. B. (2012). Developing Critical Thinking Skills in Students: A Mandate for Higher Education in Nigeria. *European Journal of Educational Research*, 1(2), 155–161.
- Adilah, D. ., & Pujayanto. (2015). Eksperimen Blended Learning dan Learning Cycle 7E Pada Sub Tema Pengelolaan Sampah Ditinjau Dari Motivasi Belajar Siswa Kelas VII SMPN 6 Surakarta. *Jurnal Materi Dan Pembelajaran Fisika*, 5(1), 42–49.
- Aiken, L. R. (1985). Three Coefficients for Analyzing The Reliability, and Validity of Ratings. *Educational and Psychological Measurement*, 45, 131–142.
- Andrew, M. ., Cobb, C. ., & Giampietro, P. . (2005). Verbal Ability and Teacher Effectiveness. *Journal of Teacher Education*, 56(4), 343–354.
- Anjani, D., & Suyatno, W. (2015). Implementasi Model Pembelajaran Susan Loucks-Horsley untuk Meningkatkan Hasil Belajar pada Pelajaran Kimia. In *Prosiding Seminar Nasional Kimia* (pp. 115–119). Surabaya: FMIPA UNESA.
- Awofala, A. O. . (2014). Examining Personalisation of Instruction, Attitudes toward and Achievement in Mathematics Word Problems among Nigerian Senior Secondary School Students. *International Journal of Education in Mathematics, Science, and Technology*, 2(4), 273–288.
- Azwar, S. (2015). *Reliabilitas dan Validitas*. Yogyakarta: Pustaka Pelajar.
- Borich, G. . (1994). *Skills Observation for Effective Teaching* (2nd ed.). New York: Macmillan Publishing Company.
- Burke, B. ., Sears, S. ., Kraus, S., & Cady, S. . (2014). Critical Analysis: A Comparison of Critical Thinking Changes in Psychology and Philosophy Classes. *Teaching of Psychology*, 41(1), 28–36. <https://doi.org/10.1177/0098628313514175>
- Creswell, J. W. (2014). *Research Design: Pendekatan Kualitatif, Kuantitatif, dan Mixed*. Yogyakarta: Pustaka Pelajar.
- Daniyati, N. ., & Sugiman. (2015). Hubungan Antara Kemampuan Verbal, Kemampuan Interpersonal, dan Minat Belajar Dengan Prestasi Belajar Matematika. *PYTHAGORAS: Jurnal Pendidikan Matematika*, 10(1), 50–60.
- Elliott, S. ., Kratochwill, T. ., Cook, J. ., & Travers, J. . (1996). *Educational*

- Psychology: Effective Teaching, Effective Learning* (3rd ed.). Boston, MA: McGraw-Hill.
- Ennis, R. . (1996). *Critical Thinking*. New Jersey: Prentice Hall, Inc.
- Firdaus, Kailani, I., Bakar, M. N. ., & Bakry. (2015). Developing Critical Thinking Skills of Students in Mathematics Learning. *Journal of Education and Learning*, 9(3), 226–236.
- Fisher, A. (2014). *Berpikir Kritis*. Jakarta: Erlangga.
- Holme, T. A., Luxford, C. J., & Brandriet, A. (2015). Defining Conceptual Understanding in General Chemistry. *Journal of Chemical Education*, 92, 1477–1483. <https://doi.org/10.1021/acs.jchemed.5b00218>
- Irawan, A. (2016). Peranan Kemampuan Numerik dan Verbal Dalam Berpikir Kritis Matematika pada Tingkat Sekolah Menengah Atas. *AdMathEdu*, 6(2), 121–130.
- Irwandani, & Rofiah, S. (2015). Pengaruh Model Pembelajaran Generatif Terhadap Pemahaman Konsep Fisika Pokok Bahasan Bunyi Peserta Didik MTS Al-Hikmah Bandar Lampung. *Jurnal Ilmiah Pendidikan Fisika Al-BiRuNi*, 4(2), 165–177. <https://doi.org/10.24042/jpifalbiruni.v4i2.90>
- James, A. ., & Adewale, O. . (2012). The Relationship Between Senior Secondary Schools Students Achievement in Mathematical Problem-Solving and Intellectual Abilities Tests. *European Scientific Journal*, 8(15), 169–179.
- Jumadi, Paidi, Atiarani, A., & Siwi, R. . (2014). Pengembangan Perangkat Pembelajaran IPA Terpadu Model Susan Loucks-Horsley. *European Scientific Journal*, 44(1), 15 – 25.
- Kola, A. J. (2017). Investigating the Conceptual Understanding of Physics through an Interactive Lecture-Engagement. *Cumhuriyet International Journal of Education*, 6(1), 82–96.
- Liliawati, W., Utama, J. ., & Fauziah, H. (2016). Susan Loucks Horsley Learning Model in Light Pollution Theme. *Journal of Physics*. <https://doi.org/10.1088/1742-6596/739/1/012141>
- Loucks-Horsley, S., Stiles, K. ., Mundry, S., Love, N., & Hewson, P. . (2010). Designing Professional Development for Teacher of Science and Mathematics. *California: Corwin*.
- Mabrurroh, F., & Suhandi, A. (2017). Construction of Critical Thinking Skills Test Instrument Related the Concept on Sound Wave. *Journal of Physics*. <https://doi.org/10.1088/1742-6596/812/1/012056>
- McCormack, A. . (1992). *Science Curriculum Resource Handbook*. New York: Kraus International Publications.
- Muiz, A., Wilujeng, I., Jumadi, & Senam. (2016). Implementasi Model Susan Loucks Horsley Terhadap Communication and Collaboration Peserta Didik SMP. *UNNES Science Education Journal*, 5(1), 1079–1084.
- Nasrun. (2014). Contextual Learning Approach in Improving Critical Thinking Skill of Guidance and Counseling Students of The State University of Medan. *International Journal of Science: Basic and Applied Research (IJSBAR)*, 18(1), 151–161.
- Nurbaeti, Nuryanti, S., & Puspitasari, I. . (2015). Hubungan Gaya Belajar dengan Keterampilan Berpikir Kritis dan Kemampuan Kognitif Siswa Pada Mata Pelajaran Kimia di Kelas X SMKN 1 Bungku Tengah. *E-Jurnal Mitra Sains*, 3(2), 24–33.
- Nurhayati, A. ., Jumadi, Wilujeng, I., & Senam. (2017). Developing a Science Learning Devices Based on Susan

- Loucks-Horsley Model to Improve Scientific Literacy and Communication and Collaboration Skills. *International Journal of Sciences: Basic and Applied Research (IJSBAR)*, 36(4), 175–184.
- Olatoye, R. ., & Aderogba, A. . (2011). Performance of Senior Secondary School Science Students in Aptitude Test: The Role of Student Verbal and Numerical Abilities. *Journal of Emerging Trends in Educational Research and Policy Studies (JETERAPS)*, 2(6), 431 – 435.
- Purnamawati, D., Ertikanto, C., & Suyatna, A. (2017). Keefektifan Lembar Kerja Siswa Berbasis Inkuiri untuk Menumbuhkan Keterampilan Berpikir Tingkat Tinggi. *Jurnal Ilmiah Pendidikan Fisika Al-BiRuNi*, 6(2), 209–219. <https://doi.org/10.24042/Jipfalbiruni.V6i2.2070>
- Raven, J. C., Court, J. H., & Raven, J. (1977). *Raven's Progressive Matrices and Vocabulary Scales*. New York: Psychological Corporation.
- Saleh, S. (2011). The Level of B.Sc.Ed Students' Conceptual Understanding of Newtonian Physics. *International Journal of Academic Research in Business and Social Sciences*, 1(3), 249–256.
- Seifi, M., Haghverdi, M., & Azizmohamadi, F. (2012). Recognition of Students Difficulties in Solving Mathematical Word Problems from the Viewpoint of Teachers. *Journal of Basic and Applied Scientific Research*, 2(3), 2923 – 2928.
- Vukovic, R. ., & Lesaux, N. . (2013). The Relationship Between Linguistic Skills and Arithmetic Knowledge. *Learning and Individual Differences*, 23, 87–91.
- Walgito, B. (2010). *Pengantar Psikologi Umum*. Yogyakarta: Andi Offset.
- Widhiarso, W., & Haryanto. (2015). Examining Method Effect of Synonym and Antonym Test in Verbal Abilities Measure. *Europe's Journal of Psychology*, 11(3), 419–431.
- Wulandari, A. Y. . (2017). Pembelajaran Menggunakan Pendekatan Konstruktivisme Berbantuan Media Animasi Komuter untuk Meningkatkan Keterampilan Berpikir Kritis mahasiswa. In *Prosiding SNPS (Seminar Nasional Pendidikan Sains)* (pp. 97–103). Surakarta: FKIP UNS.
- Yazdi, M. (2017). Development and Validation of a Persian Verbal Analogies Test Using the Rasch Model. *North American Journal of Psychology*, 19(3), 561–572.

DEVELOPING PHYSICS MONOPOLY GAME LEARNING MEDIA FOR LIGHT AND OPTICAL DEVICES

Aprilia Mayang Sari*¹, Indra Gunawan²

^{1,2} Physics Education Department, Tarbiyah and Teacher Training Faculty, UIN Raden Intan Lampung, Indonesia

*Correspondence address: Apriliamayangsari@yahoo.com

Accepted: October 30th, 2017. Approved: March 10th, 2018. Published: April 28th, 2018

Abstract: This study aims to determine the specific needs, feasibility, and responses of teachers and students toward the developed physics learning media of monopoly game on the light and optical devices material. The research procedure was based on the 4-D model. The subjects of this study were the students of State Junior High School 2 Gadingrejo. Data was collected through questionnaire. The data collected were analyzed using descriptive statistics. The results of this study were; 1) to know the specific needs in the form of filters by researchers to eliminate, replace, or modify the various components of the game into educational elements and the need for materials such as paper art paper and linen suitable for printing monopoly game designs; 2) to know the media feasibility through media and material expert's judgement. The average scores gained through the expert judgment were 4.45 and 4.24 respectively that fall into a very high category; 3) Teacher and student responses fall into the very high category with the mean score of 4.24 from teachers, 4.53 from small group testing and 4.59 from field-testing.

© 2018 Physics Education, UIN Raden Intan, Lampung, Indonesia.

Keywords: light and optical devices, learning media, monopoly game

INTRODUCTION

Education is very important for every individual to survive in these difficult times. Education could produce human beings that benefit themselves, others, society, even for the nation. An educated or knowledgeable man is different from an uneducated or illiterate man. Allah has even described His appreciation of those who are knowledgeable and educated on QS.al-Mujadalah verse 11 as follows.

يَا أَيُّهَا الَّذِينَ آمَنُوا إِذَا قِيلَ لَكُمْ تَفَسَّحُوا فِي الْمَجَالِسِ فَافْسَحُوا يَفْسَحِ اللَّهُ لَكُمْ وَإِذَا قِيلَ انشُرُوا فَانشُرُوا يَرْفَعِ اللَّهُ الَّذِينَ آمَنُوا مِنْكُمْ وَالَّذِينَ أُوتُوا الْعِلْمَ دَرَجَاتٍ وَاللَّهُ بِمَا تَعْمَلُونَ خَبِيرٌ

Meaning: O you who have believed, when you are told, "Space yourselves" in assemblies, then make space; Allah will make space for you. And when you are

told, "Arise," then arise; Allah will raise those who have believed among you and those who were given knowledge, by degrees. And Allah is Acquainted with what you do.

The Qur'an verse illustrates the importance of education for human life. Given the condition of the quality of education in Indonesia is still relatively low as indicated data from the United Nations Development Program (UNDP) on the Human Development Index rating which includes the development of education. It shows a downgrade up to recent years, and based on the data from Research And Development Agency of the Ministry of National Education it is known that from 146,052 elementary schools, there are only 8 elementary schools, from 20,918 junior high schools there are only 8 junior high schools, and from 8,036 Senior High School there are only 7 Senior High Schools, which received world recognition (Relisa, 2016). So, the government

continues to make efforts to improve the quality of education in Indonesia.

One of the government's efforts in improving the quality of education in Indonesia is to set the National Education Standards (SNP), including the standard process and standard facilities and infrastructure. In the standard process, the government has determined that learning processes in educational units are organized interactively, inspiratively, fun, challenging, and able to motivate students to participate actively, and provide sufficient space for initiative, creativity, and independence according to the talents, interests, and development of the students' physical and psychological (Peraturan Pemerintah Republik Indonesia, 2005).

Whereas in the standard of facilities and infrastructure, the government stipulates that every educational unit must have facilities that include furniture, educational equipment, educational media, books and other sources of learning, consumables items, and other equipment necessary to support a regular and continuous learning process (Peraturan Pemerintah Republik Indonesia, 2005). Based on the above government regulations, teachers are basically one of the elements that are directed to be able to create a learning condition in accordance with these standards.

Teachers in the learning process are not only required to deliver the learning materials as a whole but also required to be able to present the learning process in accordance with the interest of the students so as to grow and increase the motivation of students to participate actively and following the learning process. This is in accordance with research conducted by Rahma and Dian that educators have an obligation to meet the needs of learners (Manrulu & Sari, 2015).

Physics is one of science that studies natural physiological phenomena (Diani,

2015). The non-living natural phenomena or matter in the domain of space and time are learned in physics. Many theories of physics are denoted in mathematical notation, and the mathematics used is usually more complicated than the mathematics used in other fields of science.

This fact often leads to the assumption by the students that physics is a difficult subject to understand and ultimately has implications to lower the student physics interest, therefore a physics teacher has the task of providing learning tools and creating interactive, inspirational, , challenging, and able to motivate the students to participate actively, and providing sufficient space for initiative, creativity, and independence according to the talents, interests, and physical and psychological development of learners (Simbolon & Sahyar, 2015).

The general conditions in the field suggest that physics teaching in schools is more often performed in the classroom and using lecturing methods. Students only listen to explanations from the teacher without getting involved in the learning process. This is what causes students to become passive and less able to interact with each other (Komikesari, 2016). In physics, there are abstract and complex concepts, so it will be difficult for learners to understand the concepts if the learning process is still done using traditional learning methods (Magdin & Turcanini, 2016; A Saregar & Sunarno, 2013). Selection of appropriate learning methods and in accordance with the characteristics of learners can achieve learning objectives (Antomi Saregar, Latifah, & Sari, 2016; Yusuf & Amin, 2016). The use of appropriate learning media can help students in understanding the concepts taught, as proposed by Peoples, the use of relevant media will make the learning process effective and efficient. All the knowledge we get is 75% from seeing, 13% from listening, and 12%

from tasting, kissing and touching (Hatika, 2016).

In addition to these advantages, in learning, there are still many teachers who are not utilizing the development of learning media today.

After conducting a preliminary study at State Junior High School 2 Gadingrejo, the researchers also found similar conditions with the problems described above. It is shown through the facts gathered on the field that the learning process undertaken by the teacher is still not utilizing the development of learning media. The result could be seen from the questionnaire distributed to the students, that the use of varied learning media scored 40%. Another result of the questionnaire is that the students needed to use learning media in physics lesson with a percentage of 72.5%. Students enjoyed the learning using power point, simulation, interactive video, and other interesting media as much as 72.5%. Students felt that interesting and fun learning media can assist them in studying physics with a percentage of 87.5%.

Based on the various problems above, it is necessary to develop a new learning media that has the concept of learning while playing; one example is the physics game monopoly. physics monopoly Game was developed because it has several advantages over other learning media, namely (1) the game is fun and entertaining, (2) the game allows an active participation of the students to learn, (3) the game can provide direct feedback, (4) the game allows the application of concepts or roles into the actual situation and role in the community, (5) the game is flexible, (6) the game can be easily created and reproduced (Sadiman, 2012). Thus, researchers feel the need to conduct research entitled Developing Physics Monopoly Game Learning Media for Light and Optical Devices.

METHOD

The stages of development were based on the 4D model developed by Thiagarajan. The final product is in the form of physics monopoly game on the subject of light and optical instrument.

The development was done through research and development method. The development model used was the 4D model that includes 4 stages, namely: 1). Definition stage (defining), 2). Planning (designing), 3). Development stage, and 4). Dissemination phase (Wardoyo & Ma'arif, 2015).

This study was limited up to the development stage the time available and limited funds. The subjects of the study were eight grade students of State Junior High School 2 Gadingrejo. The research data was collected by using expert validation questionnaire, teacher response questionnaire, and student response questionnaire and then later analyzed using descriptive statistics.

The formula to count the averages:

$$\bar{x} = \frac{\sum x}{n} \dots (1)$$

exp:

- \bar{x} = Average score
- $\sum x$ = score gained
- n = number of subjects

The interpretation of the media, content expert validation score, as well as the physics teacher and the students' score, can be seen in the following table:

Table 1. Scoring system

Category	Score
Very High	5
High	4
Moderate	3
Poor	2
Very poor	1

The average score gained in the research is interpreted I the following table 2 (Sartikaningrum, 2013).

Table 2 the interval of the media and content experts as well as the teacher and the students' score

No.	Range	Criteria
1.	$X > 4,01$	Very High
2.	$3,34 < X \leq 4,01$	High
3.	$2,26 < X \leq 3,34$	Moderate
4.	$1,99 < X \leq 2,26$	Poor
5.	$X \leq 1,99$	Very poor

Table 2 is used as the basis of the average score from the experts, teacher, and the students toward the developed learning media. The feasibility of the product will fall in the Very High category if $X > 4,01$; Good if $3,34 < X \leq 4,01$; Moderate if $2,26 < X \leq 3,34$; Poor if $1,99 < X \leq 2,26$ and very Poor if $X \leq 1,99$.

RESULT AND DISCUSSION

The first result of this research is intended to investigate the specific needs of the development learning media, such as the need for filters by researchers to eliminate, replace, or modify the various components that allow the appearance of negative impression in learners to be components related to education, it needs materials such as art-paper and linen that have good quality to print the game design. These needs are identified after performing several stages of defining, designing, and developing.

The second result was intended to investigate the feasibility of instructional media through expert validation as well as through the teacher and students' response to the developed learning media, each is described as follows.

The validation was done by six experts consisting of 3 experts of media and 3 experts of material. Validation of the media experts was done by filling out an assessment questionnaire consisting of two aspects: the aspect of media engineering and the visual communication aspect. While the validation by the material experts was done by filling out the assessment questionnaire that consists

of learning aspects. After validation by the experts, the next step was the design revision. The result of the revision was then used as a material to request an assessment to the physics teacher and to conduct the product field-testing on the seventh-grade students

a. Media Experts Validation

The result of media engineering and media communication toward the developed product is presented in the following table.

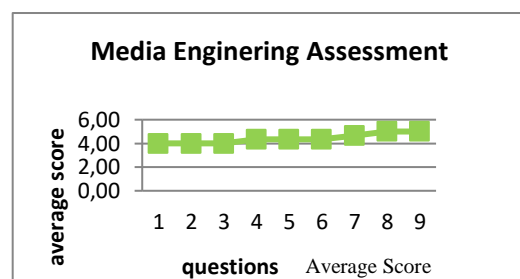

Figure 1. Average Score of the media engineering aspect

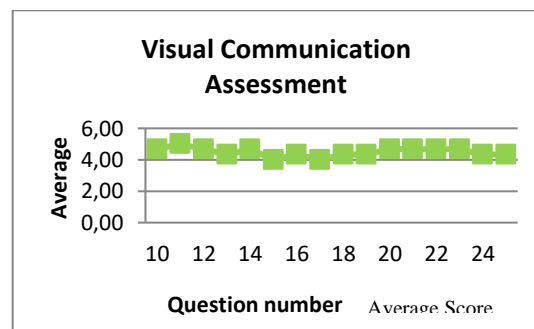

Figure 2. The average score of the visual communication aspects

Based on the calculations, the average score of 4.41 that falls into the very high category on the aspects of media engineering was obtained through nine questions, and the score of 4.48 which fall into the very high criteria for visual communication aspects was obtained using 16 questions. The average score obtained for all aspects was 4.45 so that the feasibility of the developed learning media is in the very high category

b. Material Expert Validation

The result of material expert validation on the developed product is presented in graphical form in Figure 3:

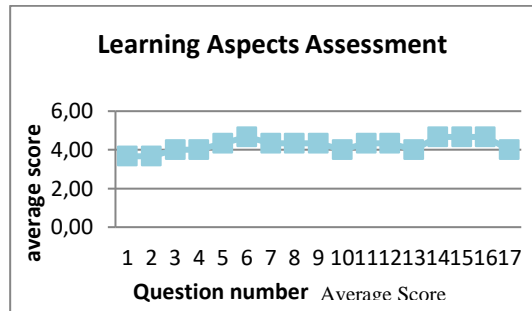

Figure 3. The average score of learning aspects by the material experts

Based on the calculation, the result of the validation of the experts obtained the average score of 4.24 which is in the very high criteria for the learning aspect which includes 17 questions, so that the feasibility of learning media of physics monopoly game based on the assessment by the material expert is in the very high criteria.

B. Physics Teacher Response

The response of the physics teacher toward the physics monopoly game was given through 3 aspects of assessment consisted of media engineering, visual communication aspect, and learning aspect. These results are generally presented in graphical form in Figure 4:

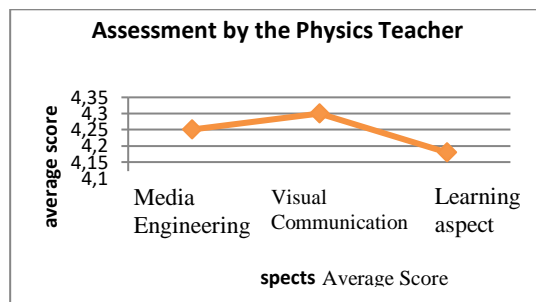

Figure 4. Physics teacher's response toward the developed product

The results of the physics teacher's assessment, the average score of 4.25 was gained that falls into the very high

category on media engineering aspects, the average score of 4.30 was gained that falls into very high category for the visual communication aspect, and the average score of 4.18 was gained that falls into very high category for aspects of learning. So, as a whole, the physics monopoly game developed got the response within the very high category for all aspects with the average score of 4.25.

b. Students' Response

Students' responses toward the developed were taken through 3 aspects of assessment, namely media engineering aspect, visual communication aspect, and learning aspect through a small group-testing stage and field-testing stage. Small group testings were conducted to 10 students and the field-testing to 30 students of the State Junior High School Gadingrejo. These results are generally presented in graphical form in Figure 5.

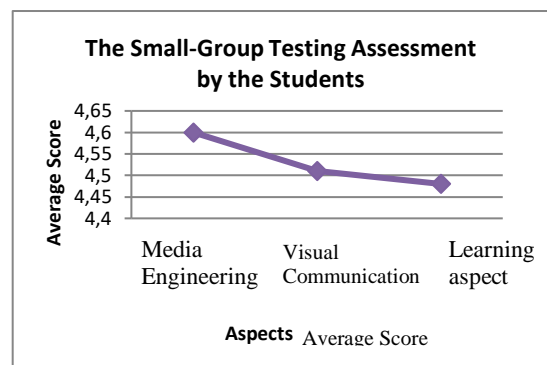

Figure 5. Students' response toward the developed learning media

The results of the students' response through small- group testing obtained a mean score of 4.60 which is in the very high category for media engineering aspects, the average score of 4.51 which fall into the very high category for visual communication aspects was gained, and the average score of 4.48 which fall into very high category for the learning aspect was also gained. So, developed physics monopoly game as a whole got response

of very high category for all aspects with the average score of 4.53.

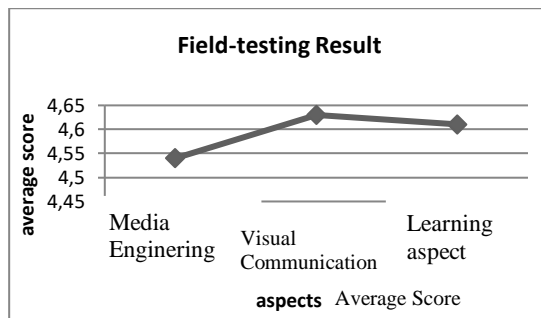

Figure 6. Students' response toward the developed product

The result of the assessment of the field-testing, the average score of 4.54 was obtained that belong to the very high criteria for media engineering aspects, the average score of 4.63 was obtained that belong to the very high category for the visual communication aspect, and the average score of 4.61 that belong to the very high category for the learning aspect. So, the developed Physics monopoly game as a whole got the response with the very high criteria for all aspects with the average score of 4.59.

The advantages of physics monopoly game on the subject of light and optical devices are:

- a. Overall, the learning media of physics monopoly game felt into the Very Good category for all aspects, namely media engineering aspect, visual communication aspect, and learning aspect, so it can be used as one of learning media both inside and outside of class.
- b. The aspects that may cause negative effects to the students were charged with the aspects of education as a medium of learning. For example, the money used in monopoly game is replaced with flashcards to minimize the emergence of the nature of materialism; the "Jail" section of the original monopoly was replaced with the instruction to open a worksheet to avoid negative impression for students.

- c. This learning media is equipped with question cards containing various questions that get the assessment with the very good criteria for the adequacy of the question numbers, the completeness of the scope of the problem, and the variation of the problem that can be used as student training materials to answer questions related to the material of light and optical devices.

This learning media was supplemented by the results of the students' rating card in the field-testing, the average score of 4.54 was obtained which belong to the very good category for media engineering aspects, and the average score of 4.63 was obtained which belong to the very high category for aspects of learning. So, the developed physics monopoly game as a whole got the response with the very good category for all aspects with the average score of 4.59.

The advantages of learning of physics monopoly game on the subject of light and optical devices are:

- a. Overall, the learning media of monopoly physics game got the assessment with the very high category for all aspects, namely media engineering aspect, visual communication aspect, and learning aspect, so it can be used as one of learning media both inside and outside of the classroom.
- b. The aspects that may cause negative effects to the students were charged with the aspects of education as a medium of learning. For example, the money used in monopoly game is replaced with flashcards to minimize the emergence of the nature of materialism; the "Jail" section of the original monopoly was replaced with the instruction to open a worksheet to avoid negative impression for students.
- c. This learning media is equipped with question cards containing various questions that get the very good

- assessment category for the adequacy of the question numbers, the completeness of the scope of the problem, and the variation of the problem that can be used as student training materials to answer questions related to the material of light and optical devices.
- d. The collection of information related to learning materials that got a very good assessment category for the appropriateness of the learning materials with the basic competence, learning indicators, learning objectives, and actuality of the material presented, so it can be used as learning materials for students and increase the knowledge of students
 - e. The physics monopoly game is designed in a different form than the general monopoly game. In this media, the rules and procedures of the game of physics monopoly are described in a game manual equipped with drawings and supporting manuals which got a very high assessment category for indicators of clarity of instructions, so it can facilitate the students in understanding the course of the game.
 - f. This media comes with an answer key for the question cards that got a very good assessment category for the accuracy aspect, so it can provide immediate feedback to students. In addition, the key answer can be used as a guide to correct students' answers to the questions contained in the question card.
 - g. The use of physics monopoly game as a learning media can increase participation of the students because in the course of the game, all students are directly involved either as a player or officer with their respective duties. In addition, the use of learning media can also increase the motivation of students.
 - h. The use of physics monopoly game as a learning media can make learning

more enjoyable, without neglecting the actual learning objectives. Because in this media one of the rules requires the students to identify the questions that cannot be answered during the game by confirming the teacher's answer. At the end of the game, students are asked to confirm the information gathered by the teacher during the game, so that it can be used as correction material by the teacher.

The weaknesses of the developed learning media are:

- a. Monopoly is a game that has the characteristics of competition and power struggles, to avoid the negative things arises, the teacher as a facilitator in learning and director of the game should emphasize to the students that the media used is for learning purposes.
- b. Monopoly game is a group game that is difficult to control as not to be separated from the actual learning objectives. Therefore, teachers as facilitators in learning and directors in the use of media must affirm that the use of learning media of this game is not only for playing games, but at the end of the game, the students are asked to confirm any questions that cannot be answered, and what information the students get during the game.

CONCLUSION AND SUGGESTION

Conclusion

1. The specific needs of the developed learning media of physics monopoly game on the subject of light and optical devices such as the need for filters by researchers to eliminate, replace or modify various components in the game that allows the negative impression on students into elements of education, so the physics monopoly game can be used as a medium of learning. In addition, it takes materials such as 210 gram of art paper and Linen to print the physics monopoly game designs, since the quality of those materials is suitable for developing this

media; 2. The feasibility of learning media of physics monopoly game on the subject of light and optical devices in terms of media engineering, visual communication aspect, and learning aspect based on the result of media and material expert validation in the whole development stages is in the very high category, it means that the media deserves to be used as a media in learning; 3. Teachers and students' responses toward the learning media of the physics monopoly game on the subject of light and optical devices in terms of media engineering, visual communications aspects, and overall learning aspects are in the very high category.

Suggestion

The teachers could utilize learning media such as physics monopoly game in teaching and learning activity especially in the light and optical devices; For further researchers, it is better to broaden the target of the product into a wider range.

REFERENCES

- Diani, R. (2015). Pengembangan Perangkat Pembelajaran Fisika Berbasis Pendidikan Karakter Dengan Model Problem Basen Instruction. *Jurnal Ilmiah Pendidikan Fisika Al-Biruni*, 4(2), 241–253. Retrieved from <https://doi.org/10.24042/jpifalbiruni.v4i2.96>
- Hatika, R. G. (2016). Peningkatan Hasil Belajar Fisika dengan Menerapkan Model Pembelajaran Advance Organizer Berbantu Animasi Komputer. *Jurnal Pendidikan Fisika Indonesia*, 12(2), 113–117. Retrieved from <https://doi.org/10.15294/jpfi.v12i2.5210>
- Komikesari, H. (2016). Peningkatan Keterampilan Proses Sains dan Hasil Belajar Fisika Siswa pada Model Pembelajaran Kooperatif Tipe Student Team Achievement Division. *Jurnal Keguruan Dan Ilmu Tarbiyah*, 1(1), 15–22.
- Magdin, M., & Turcanini, M. (2016). Modeling Behavior of Students in E-learning Courses on the Basis of Use Interactive Animations. *Turkish Online Journal of Educational Technology*, 15(1), 62–68.
- Manrulu, R. H., & Sari, D. N. (2015). Efektivitas Kegiatan Lesson Study dalam Merancang Pembelajaran pada Mata Kuliah Gelombang dan Optik. *Jurnal Ilmiah Pendidikan Fisika Al-Biruni*, 4(2), 229–239. Retrieved from <https://doi.org/10.24042/jpifalbiruni.v4i2.95>
- Peraturan Pemerintah Republik Indonesia. Peraturan Pemerintah Republik Indonesia No.19 Tahun 2005 tentang Standar Nasional Pendidikan Pasal 42, ayat 1 (2005).
- Relisa. (2016). Kajian Prasarana Pendidikan Sekolah Dasar sebagai Salah Satu Indikator Pencapaian Standar Nasional Pendidikan. *Jurnal Pendidikan Dan Kebudayaan*, 1(1), 81–96.
- Sadiman, A. S. (2012). *Media Pendidikan: Pengertian, Pengembangan dan Pemanfaatannya*. Depok: Rajawali Pers.
- Saregar, A., Latifah, S., & Sari, M. (2016). Efektivitas Model Pembelajaran CUPs: Dampak Terhadap Kemampuan Berpikir Tingkat Tinggi Peserta Didik Madrasah Aliyah Mathla'ul Anwar Gisting Lampung. *Jurnal Ilmiah Pendidikan Fisika Al-Biruni*, 5(2), 233–243. <https://doi.org/10.24042/jpifalbiruni.v5i2.123>
- Saregar, A., & Sunarno, W. (2013). Eksperimen dan Demonstrasi Diskusi menggunakan Multimedia Interaktif ditinjau dari Sikap Ilmiah dan Kemampuan Verbal Siswa. *Jurnal*

- Inkuiri*, 2(2), 100–113.
- Sartikaningrum, R. (2013). Pengembangan Media Pembelajaran Permainan Monopoli Akuntansi untuk Meningkatkan Motivasi Belajar Siswa Kelas X Program Keahlian Akuntansi SMK Negeri 1 Tempel. *Universitas Medan*. Retrieved from <https://doi.org/10.1007/s13398-014-0173-7.2>
- Simbolon, D. H., & Sahyar. (2015). Pengaruh Model Pembelajaran Inkuiri Terbimbing Berbasis Eksperimen Riil dan Laboratorium Virtual Terhadap Hasil Belajar Fisika Siswa. *Jurnal Pendidikan Dan Kebudayaan*, 21(3), 299–316.
- Wardoyo, T. C. T., & Ma'arif, F. (2015). Pengembangan Media Pembelajaran Berbasis Video Animasi pada Mata Pelajaran Mekanika Teknik di SMK Negeri 1 Purworejo. *Jurnal Pendidikan Teknik Sipil Dan Perencanaan*, 1–7.
- Yusuf, M. T., & Amin, M. (2016). Pengaruh Mind Map dan Gaya Belajar terhadap Hasil Belajar Matematika Siswa. *Tadris: Jurnal Keguruan Dan Ilmu Tarbiyah*, 1(1), 85–92.

WEB-ENHANCED COURSE BASED ON PROBLEM-BASED LEARNING (PBL): DEVELOPMENT OF INTERACTIVE LEARNING MEDIA FOR BASIC PHYSICS II

Rahma Diani*¹, Yuberti², M. Ridho Syarlisjisman³

^{1,2,3} Physics Education Department, Universitas Islam Negeri Raden Intan Lampung, Indonesia.

*Correspondence address: rahmadiani@radenintan.ac.id

Accepted: January 29th, 2018. Approved: April 19th, 2018. Published: April 28th, 2018

Abstract: This research aims to develop an active learning media in the form of Web-Enhanced Course. This research and development research follows the development steps of Borg & Gall. Data collection instruments used were validation sheets and questionnaires. The assessments' average score for the feasibility of the product from the material experts is 84.83%, from media experts is 81.76%, and informatics experts are 83.61% in the very feasible category. Furthermore, the percentage of the results of small-group testing is 76.44% and for field-testing is 82.97%. Thus, the developed product is suitable to be used as a media for physics learning. The web is developed using the Problem-Based Learning (PBL) for the Basic Physics II subject.

© 2018 Physics Education Department, UIN Raden Intan, Lampung, Indonesia.

Keywords: *interactive, physics learning media, problem-based learning model, web-enhanced course.*

INTRODUCTION

The information and communication technology is developing rapidly. One of the fields that are impacted significantly is the field of education. To keep up with the rapid technological development, education must have a great interest in keeping up with technological developments (Asyhari & Diani, 2017). As stated in the Law of the National Education System Number 20 of 2003 that education is a process to help humans develop their potential so that they are able to face every change and make students think actively and creatively (Amri, 2014). If the students are able to think creatively, they will be able to solve problems appropriately (Antomi Saregar, Latifah, & Sari, 2016).

As we know that men are the most perfect and noble being, Allah the Almighty blesses them with mind and though, so that humans will be able to work creatively, to produce science and technology in their lives (Yuberti, 2015)

The Qur'an provides a lot of information about science and technology proven through amazing studies and experiments. It is indeed the will of Allah to all beings to submit to His command. Science and technology explains the phenomenon of the universe and the universe itself proves the truth of the Qur'an which is interpreted consistently and does not conflict with our knowledge (Al-zindani, Aziz, & DKK, 1997)

Along with the development globalization era which is characterized by rapid production and usage of information and technology, the conception of the implementation of learning has shifted toward the efforts to realize modern learning. Basically, the modern characteristics have previously been achieved in the development of education and learning, but it is still in the level of software intelligence (Habibi & Kurniawan, 2014), the world of education is always moving forward dynamically especially to create interesting,

interactive, and comprehensive media, methods and educational materials. Therefore our education sector must be able to utilize information and technology to develop electronic media-based education or known as e-education (Habibi & Kurniawan, 2014).

Etymologically, the word media comes from the Latin word and is the plural form of the word medium which literally means intermediary or introduction. Thus, the media is a vehicle for distributing learning information or channeling messages (Arsi & Febrianti, 2014; Gunawan, 2014). The internet has become the pioneer of the technological revolution (Sutedjo, 2002). The Internet is a type of media that can create two-way or more online interactions. The internet is a huge force. An incredible number of users making the internet as an effective and multi-purpose tool (Hidayatullah & Kawistrara, 2017). As for Indonesia, according to data released by APJII (Indonesian Internet Service Users Association), Internet users in 2012 amounted to 63 million people. While the growth of internet users in 2016 reached 132.7 million people from the total population of 256.2 million people (APJII, 2016).

Based on these data, this media is increasingly popular to be used to develop learning activities in schools, universities, or courses because, in addition to being interactive, this media is connected to the global network so that the access range is very widespread throughout the country (Habibi & Kurniawan, 2014). Indonesia ranks second in terms of the growth of internet usage in the world up to November 2015 which reached 88.1 million people or around 34% of the total population of Indonesia (Irwandani, 2016).

There are three forms of internet learning systems that are worth considering as the basis for developing a learning system using the internet, namely web courses, web-centric courses, and

web-enhanced courses (Alfath, Ellianawati, & Sukisno, 2013).

The web course is the use of the internet in educational activities. All educational activities are carried out through the internet such as teaching materials, discussions, assignments, etc so that they no longer need do the activities face-to-face. The web-centric course is similar to web courses. However, in the web-centric course, there are face-to-face activities between lecturers and students. Face-to-face activities contain discussions about the material that has been learned through the internet. The web-enhanced course is also known as the web lite course where the main activity is face to face. The internet is only a mean to provide enrichment. In this case, the lecturer must have the ability to recommend relevant learning material sources and are required to master information seeking techniques (Alfath et al., 2013).

Rapid technological development can be responded to by renewing the use of technology in the learning process (Antomi Saregar, 2016) and mastering scientific concepts, including Physics. Physics is a scientific discipline that has its own characteristics compared to other scientific disciplines (S.Ramos, B.Dolipas, & B.Villamor, 2013). In Physics learning, concept understanding is highly emphasized (Ulya, 2013). Mastery of concepts and ability to solve Physics learning problems is one aspect in measuring the improvement of students' learning outcomes in order to realize quality learning that can be supported by using computer assistance (Doyan & Sukmantara, 2014). Therefore, problem-solving in scientific disciplines requires scientific methods (A. Saregar & Sunarno, 2013).

Through this media, the students can actively learn independently by only accessing the website through computer screens that are connected to the internet

network (Habibi & Kurniawan, 2014). Computers connected to the internet network will provide web services that function to help students and lecturers in the learning process. The use of the web is expected to make it easier for the students to understand abstract Physics material, re-learn in the difficult part of the material, and get reinforcement by reading learning resources such as electronic books, articles, and practice questions prepared by the lecturers (Doyan & Sukmantara, 2014)

Web-based learning media or e-learning which is now becoming very popular because of its flexibility and effectiveness is a way of delivering learning material via the internet that can be accessed anytime and from anywhere. The presence of e-learning can be a new hope and a solution to overcome the problems of education and learning (I. Wahyudi, 2017). The web can be used by students as a means to get Physics material whenever and wherever they need it or as a medium for discussion and practice. In addition, this study will also develop an existing web-based interactive Physics learning media by fulfilling the principles of media development (Putri, 2015).

The problem-based Learning model is a model of learning that requires students to develop thinking skills, problem-solving and intellectual skills, foster collaboration capabilities, and developing social attitudes. This model designs problems that require the students to gain important knowledge, make them proficient in solving problems, have their own learning strategies, and have the skills to participate in group activities. The Problem-Based Learning model is expected to provide opportunities for the students to be able to improve their scientific work skills (BS Wahyudi, 2014).

The observation found out that lecturers were still using printed media or

printed books in carrying out the learning process which requires considerable time, consequently, the lecturers did not maximize the time in delivering material that affects students. The material provides by the researchers here is the Basic Physics II subject of electricity and electric field. Developing a physics learning media based on Web-enhanced courses with Problem-Based Learning model can be done as an alternative in learning. The support of internet network, infrastructure, and facilities at the Physics Education Department and the lecturers and students' ability to use computers is expected to facilitate the students in understanding the physical material (Doyan & Sukmantara, 2014).

The results of the interview show that there were several problems that exist in online-based learning media in the Physics Education Department, namely, there are still many students who do not know the existence of an interactive learning system in the form of interactive physics learning media based on Web-enhanced courses with Problem-Based Learning (PBL) model.

Based on the results of the interview, the researchers developed an interactive Physics learning media in the form of web-enhanced course with Problem-Based Learning model as a mean of online learning media for students to accommodate their need to be more mobile and effective. To know the product's assessment criteria from material experts, media experts, and informatics experts. As well as to know the students' responses in small-group testing and field-testing related to the attractiveness and feasibility of the developed product.

METHOD

This study employed Research and Development method. According to Gay, Mills, da Airasian in the field of education, the main goal of research and

development is not to formulate or test the theory, but to develop products that can be used effectively (Emzir, 2015). The Research and Development procedures were guided by the instructional media development design by Borg and Gall. The final product is a web-based interactive Physics learning media of web-enhanced course with Problem-Based Learning (PBL) model in Basic Physics II course.

The development was done through the Research and Development method. The development model used in this study was from the Borg and Gall model in Sugiyono, namely: 1). Potential and Problems, 2). Data collection, 3). Product design, 4). Design validation, 5). Design revision, 6). Product testing, 7). Product revision, 8). Field testing, 9). Product revision, 10). Dissemination.

This study limited the steps of the development from ten steps to seven steps because of the time available and limited opportunities. Research subjects for small-group testing were ten second semester students of the Physics Education Department of UIN Raden Intan Lampung. Field-testing were conducted to sixty second semester students of the Physics Education Department of UIN Raden Intan Lampung and the second-semester students of the Physics Education Department of the University of Lampung. Research data was collected using expert validation sheets and student response sheets and the data analysis was done using a Likert scale.

Data analysis was done using the following formula:

$$x_i = \frac{\sum S}{S_{max}} \times 100 \%$$

Description:

S_{max} = Maximum score

$\sum S$ = score

x_i = Feasibility score for each aspect (Sugiono, 2013)

The questionnaire used to investigate the responses toward the use of web-enhanced course interactive Physics learning media with Problem-Based Learning model (PBL) was in accordance with the content of the question. The interpretation of the assessment results of the media expert, subject matter experts, and Informatics experts from alphabetical into numerical form follows the following guideline:

Table 1. Scoring Norm

Category	Score
SB (Excellent)	5
B (Good)	4
C (Moderate)	3
K (Low)	2
SK (Bad)	1

The students were given a questionnaire to investigate their responses toward the attractiveness of the web-enhanced course interactive physics learning media with Problem-Based Learning model (PBL). To know the final score of the questionnaire, the researchers used mean item analysis by counting the feasibility score divides by the number of statements.

The results of the percentage score obtained from the research were interpreted using the following criteria:

Table 2. The feasibility score of the learning media

The Feasibility Score of the Learning Media	Criteria
0 - 20%	Not feasible
20.01% - 40%	Less feasible
40.01% - 60%	Quite feasible
60 , 01% - 80%	Feasible
80.01% - 100%	highly feasible

RESULTS AND DISCUSSION

The aim of this research is to develop an interactive Physics learning media in the form of Web-Enhanced Course with Problem-Based Learning model (PBL) in the Basic Physics II course. The developed product is potentially useful to minimize problems in the classroom where the lecturers still use printed media or printed books in carrying out the learning process that requires quite a lot of time, resulting in the less optimum time in delivering material that affects students. In this stage, the important thing to do was to analyze the needs of learning evaluation of the developed product through unstructured interviews with the lecturers of Physics Education UIN Raden Intan Lampung. In the classroom during the learning process, the teachers were still using printed media which was very time consuming and was not conducive so that the material that must be explained cannot be delivered appropriately. The students found it difficult when working on questions given by the lecturer during the evaluation.

Next is the data collection. Data collection is very important to know the

needs of lecturers and students toward the developed product. The first step was to conduct an analysis on the lecturers which concerned about the products they want to develop. Based on the results of the analysis, the lecturers were in dire need of an interactive physics learning media in the form of Web-Enhanced Course with Problem-Based Learning model (PBL) in the Basic Physics II subject which can minimize the duration of learning so that learning could be more effective and efficient. After that, the researchers analyzed the students' responses toward the developed product which mostly state that the developed product gave more benefits during the learning activities.



The preparation steps of the product development were done by deciding ideas, analyzing the material to be displayed, specifying the web system to be created (content material in the form of text, images, video learning, PhET simulations, and exercises), and determining the web hosting and domain.

The following are some displays of the developed product.

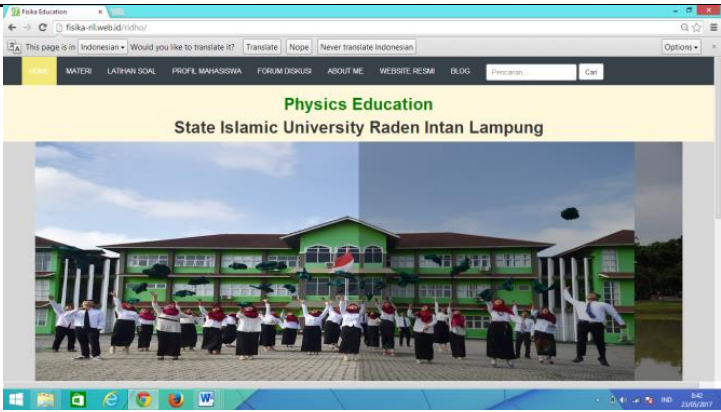
Table 3. The Display of Web-Enhanced Course with Problem-Based Learning model (PBL)

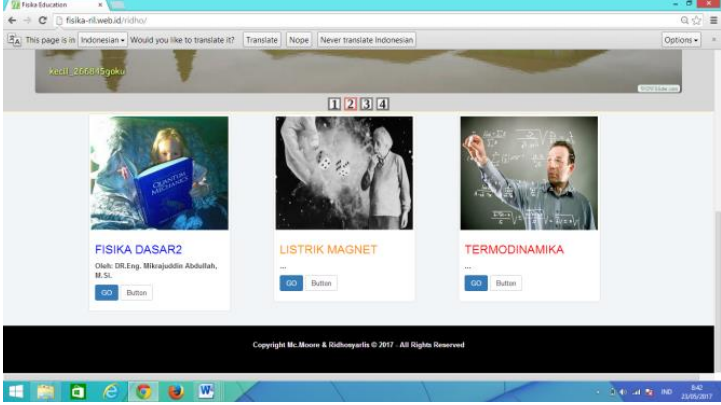
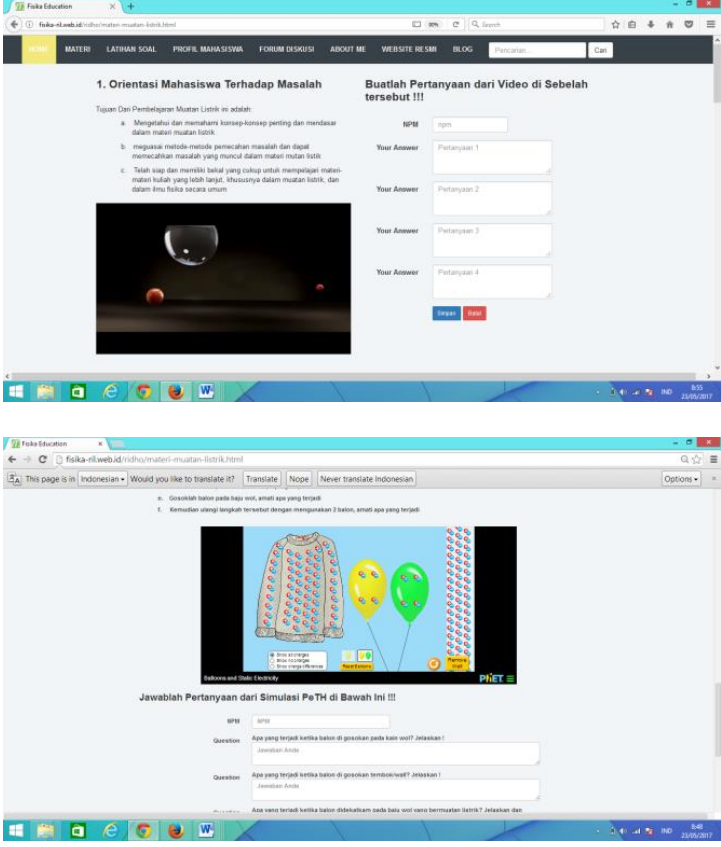
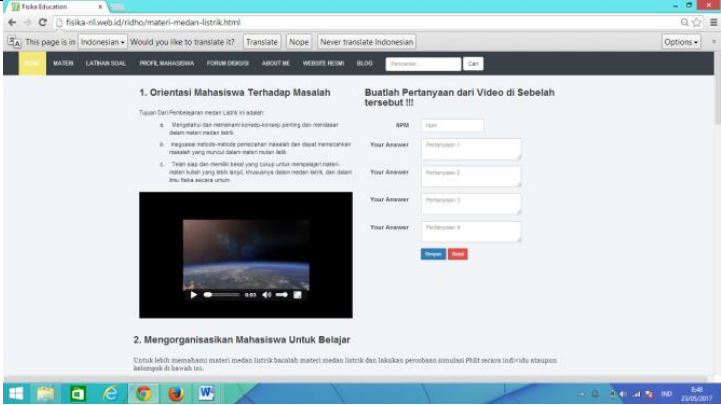
No	Title	Display
1	Home Display of the Website (fisika -ril.web.id)	

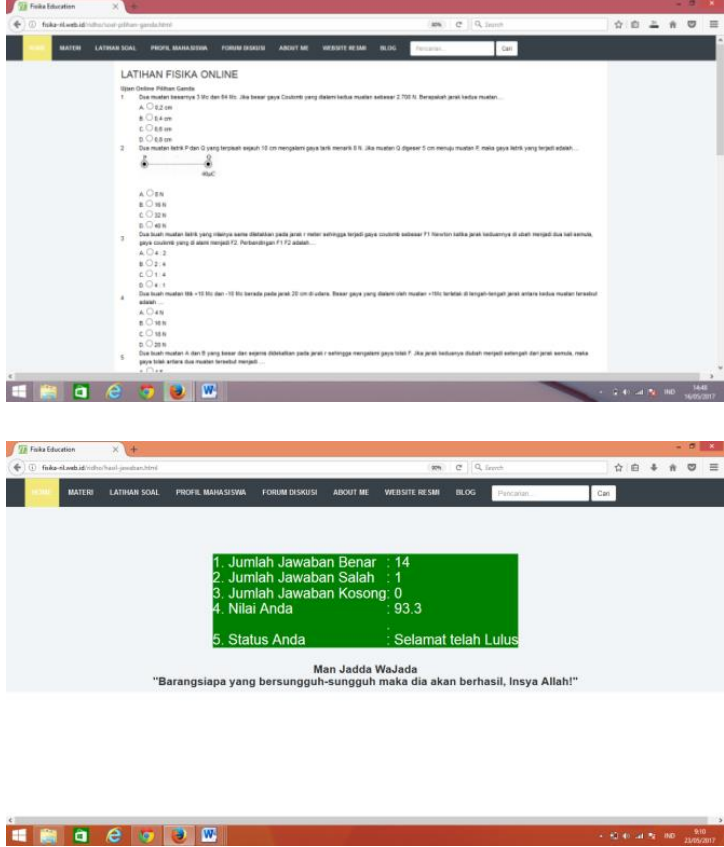
		
<p>2</p>	<p>The Display of Material (Electric Charge) (fisika-ril.web.id)</p>	
<p>3</p>	<p>The Display of Material (Electric field) (fisika-ril.web.id)</p>	

																														
<p>4</p>	<p>The Display of exercises (fisika -ril.web.id)</p>																													
<p>5</p>	<p>The Display of Students' Profile (fisika -ril.web.id) (Student Data)</p>	 <table border="1" data-bbox="691 1675 1238 1756"> <thead> <tr> <th>No</th> <th>NIS</th> <th>Nama</th> <th>Semester</th> <th>Kelas</th> <th>Dosen</th> <th>Kontak Person</th> </tr> </thead> <tbody> <tr> <td>1</td> <td>131103073</td> <td>KIKI RIDO ARMELA</td> <td>8</td> <td>B</td> <td>INDRA GUNAWAN, M.T</td> <td>08129274975</td> </tr> <tr> <td>2</td> <td>131103115</td> <td>MUHAMMAD RIZHO SYARILUSBIWANI</td> <td>8</td> <td>C</td> <td>RAHMA DAMI M Pd</td> <td>08227340719</td> </tr> <tr> <td>3</td> <td>1511030123</td> <td>ANDRIA PUTRI NABILA</td> <td>2</td> <td>A</td> <td>MUHAMMAD MANSUR, S.Kom, M.Pd, M.Ti</td> <td>081279427961</td> </tr> </tbody> </table>	No	NIS	Nama	Semester	Kelas	Dosen	Kontak Person	1	131103073	KIKI RIDO ARMELA	8	B	INDRA GUNAWAN, M.T	08129274975	2	131103115	MUHAMMAD RIZHO SYARILUSBIWANI	8	C	RAHMA DAMI M Pd	08227340719	3	1511030123	ANDRIA PUTRI NABILA	2	A	MUHAMMAD MANSUR, S.Kom, M.Pd, M.Ti	081279427961
No	NIS	Nama	Semester	Kelas	Dosen	Kontak Person																								
1	131103073	KIKI RIDO ARMELA	8	B	INDRA GUNAWAN, M.T	08129274975																								
2	131103115	MUHAMMAD RIZHO SYARILUSBIWANI	8	C	RAHMA DAMI M Pd	08227340719																								
3	1511030123	ANDRIA PUTRI NABILA	2	A	MUHAMMAD MANSUR, S.Kom, M.Pd, M.Ti	081279427961																								

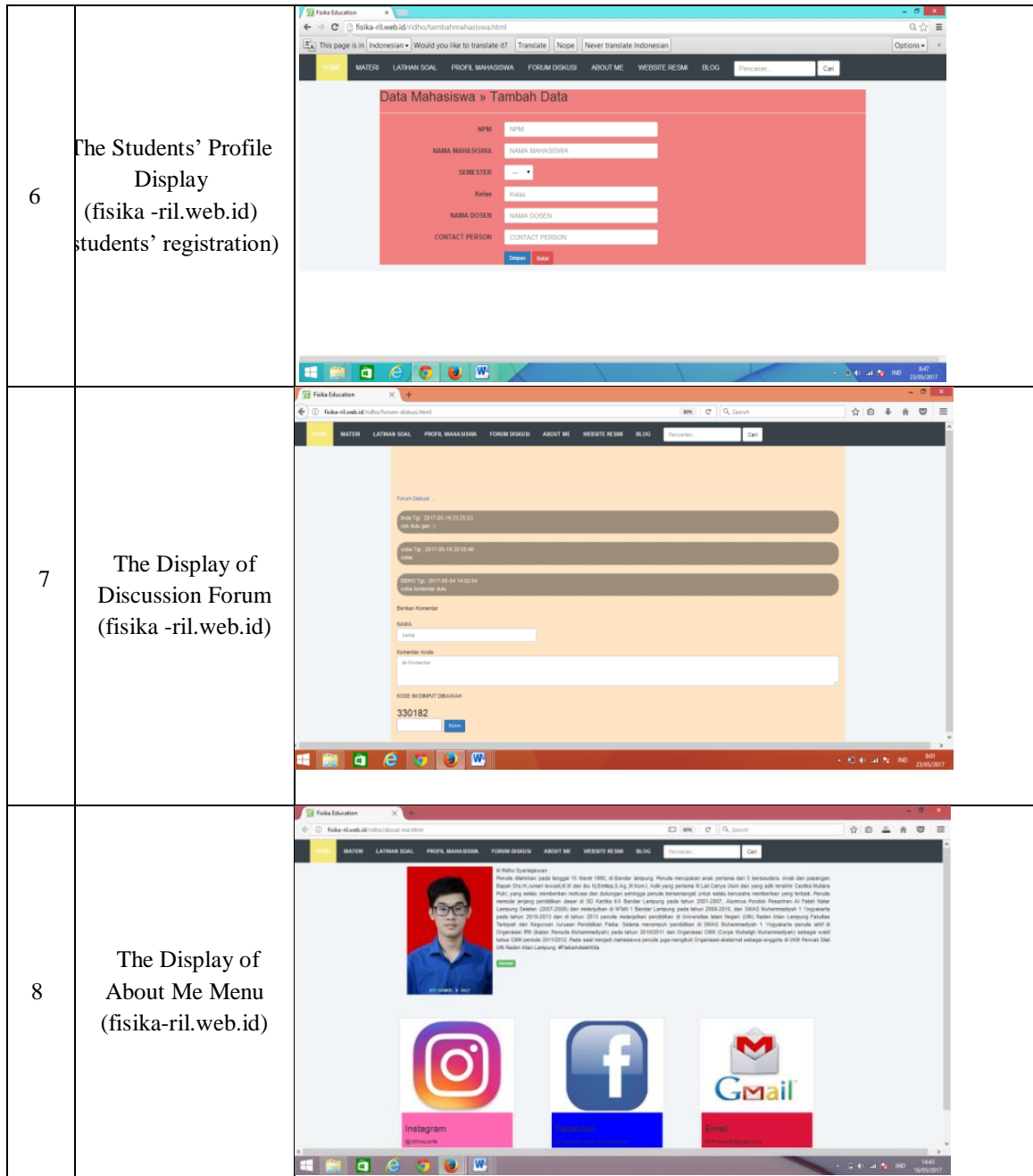

The developed product was validated by several experts before being tested in the field. Validation was carried out by 3 material experts, 3 media experts and 3 informatics experts.

a. Validation Results by Material Expert

The result of validation by material experts toward the product is presented in the following table.

Table 4. Validation Results by Material Expert

No	Aspect Assessment	Feasibility Percentage
1	Quality of Content Material	82.5%
2	Linguistic Aspects	85%
3	Material Implementation	84.8%
4	Visual Layout	76.7%
5	Audio Aspects	88.9%
6	Easiness of the Usage	93.3%
7	Problem-Based Learning Model	82, 7%
	average	84.83%

Based on the table. 4, it can be seen on the aspect of the quality of content material gained 82.5% of the feasibility percentage. The linguistic aspect gained 85% of the feasibility percentage. The material implementation aspect gained 84.8% of the feasibility percentage. The visual layout of the material aspect gained 76.7% of the feasibility percentage. The audio aspect gained 88.9% of the feasibility percentage. The easiness of the usage aspect gained 93.3% of the feasibility percentage, and the problem-based learning model aspect gained 82.7% of the feasibility percentage. The average percentage from the material experts' assessment gained 84.83% of the feasibility percentage. The assessment result from the material experts was in the highly feasible category.

b. Validation Results by Media Experts

The results of validation by media/design experts on the developed product is presented in the following table:

Table 5. Validation Results by Media Experts

No	Aspects of Assessment	Feasibility Percentage
1	Quality of Content Material	86.7%
2	Linguistic Aspects	82.2%
3	Material Implementation	80%
4	Visual Layout	81.7%
5	Audio Aspects	83.3%
6	Easiness of the Usage	76.7%
Average		81.76%

Based on the table. 5, it can be seen on the aspect of the quality of content material gained 86.7% of the feasibility percentage. The linguistic aspect gained 82.2% of the feasibility percentage. The material implementation aspect gained 80% of the feasibility percentage. The visual layout of the material aspect gained 81.7% of the feasibility percentage. The audio aspect gained 83.3% of the

feasibility percentage. The easiness of the usage aspect gained 76.7% of the feasibility percentage. The average score from the media experts gained 81.76% of the feasibility percentage. So the result of the assessment by the media experts was in the highly feasible category.

c. Validation Results by Informatics Experts

The results of validation by informatics experts on the developed product is presented in the following table:

Table 6. Validation Results by Informatics Experts

No	Aspect Assessment	Feasibility Percentage
1	Content Quality	80%
2	Lay out	82.2%
3	Coloring	86.7%
4	Fonts	91.1%
5	Images, Videos, and PhET Simulations	86.7%
6	Icon	82.2%
7	Audio Quality	86.7%
8	Easiness of the Usage	73.3%
Average		83.61%

Based on table 6, it can be seen on the aspect of the quality of content material gained 80% of the feasibility percentage. The lay out aspect gained 82.2% of the feasibility percentage. The coloring aspect gained 86.7% of the feasibility percentage. The font aspect gained 91,1% of the feasibility percentage. The Images, Videos and PhET Simulations aspect gained 86.7% of the feasibility percentage. The icon aspect gained 82.2% of the feasibility percentage. The audio quality aspect gained 86.7% of the feasibility percentage, and The easiness of the usage aspect gained 73.3% of the feasibility percentage. The average score from the Informatics experts gained 83.61% of the feasibility percentage. So the result of the

assessment by the informatics experts was in the highly feasible category.

d. Product Testing

The testing of the revised learning media was carried out in two places: first, to the two classes of the second semester students of the Physics Education Department UIN Raden Intan Lampung and one class of the second semester students of the Physics Education Department, University of Lampung. The testing was in the form of small-group testing and field-testing. The product testing was conducted during the learning process, after learning by using the interactive Physics learning media in the form of Web-Enhanced Course with Problem-Based Learning model (PBL) in the Basic Physics II subject. The students were asked to fill in the questionnaire.

Student questionnaire consisted of 3 aspects of assessment, namely aspects of content quality, aspects of media lay out, and aspects of technical quality. In small-group testing was conducted on the second semester students of the of Physics Education Department of UIN Raden Intan Lampung, the feasibility of the learning media gained 76.44% in the Feasible category. The data of the small-group testing can be seen in the following figure:

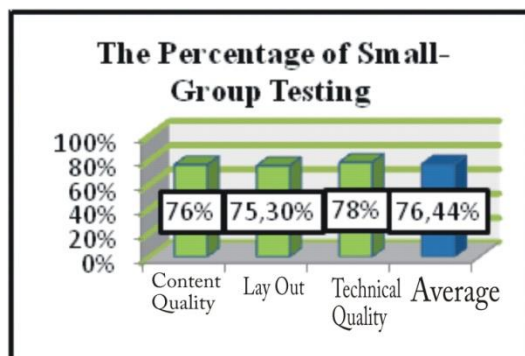

Figure 1. Small-Group Testing of Physics Education Department of UIN Raden Intan Lampung

Field-testing was conducted on the second semester students of the of Physics Education Department of UIN Raden

Intan Lampung. The feasibility percentage gained was 83.45% in the highly feasible category. The field-testing was conducted on the second semester students of the Physics Education Department, the University of Lampung, the feasibility percentage gained was 81.38% in the highly feasible category. The combination of the percentage of feasibility gained from the two universities resulting in the average percentage of 82.34% in the highly feasible category. Data from the small-group testing of the two universities can be seen in the following figure:

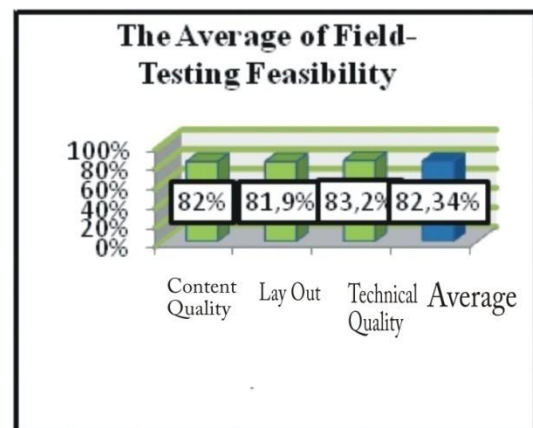

Figure 2. The Average Field-testing result of the Two Universities

Based on the stages carried out in this research, the developed learning media possesses a very good quality and is suitable to be used by students in the learning process especially for the second semester of the Physics Education Department. The interactive Physics learning media in the form of Web-Enhanced Course with Problem-Based Learning model (PBL) shows that the material and practice questions have fulfilled the criteria as a good Physics learning media.

CONCLUSIONS AND SUGGESTIONS

Conclusion

Based on the research, the following conclusions can be drawn.

1. The developed product is an interactive Physics learning media in the form of Web-Enhanced Course with Problem-Based Learning model (PBL) in the Basic Physics II subject that can be accessed online through the website: phys-ril.web.id. The features of the website are the collection of materials in the form of text, images, videos, PhET simulations, discussion forums, practice questions, and assessments. The interactive Physics learning media in the form of Web-Enhanced Course with Problem-Based Learning model (PBL) in the Basic Physics II subject can be applied in the learning process for the Physics Education Department students of UIN Raden Intan Lampung.
2. Validators Responses toward the interactive Physics learning media in the form of Web-Enhanced Course with Problem-Based Learning model (PBL) in the Basic Physics II subject were gained from material experts, media experts, and Informatics experts with ideal percentages of 84.83 %, 81.76%, and 83.61%.
3. The feasibility of the developed products in small-group testing and field-testing conducted at the Physics Education Department of UIN Raden Intan Lampung and the Physics Education Department of Lampung University gained a positive response. The ideal percentage gained from the two universities for both testings were 74.47% and 82.34%. This result proves that the interactive Physics learning media in the form of Web-Enhanced Course with Problem-Based Learning model (PBL) is very effective, efficient, and feasible to be applied.

Suggestion

It is suggested for the interactive Physics learning media in the form of Web-Enhanced Course with Problem-Based Learning model (PBL) in the Basic Physics II subject to be developed further

so that it can be utilized more optimally and the existing data can be accessed properly. It also needs to be developed for other physics subjects.

REFERENCES

- Al-zindani, Aziz, A. majid bin, & DKK. (1997). *Mukzijat Al-Qur'an dan As-Sunnah Tentang IPTEK*. Jakarta: Gema Insani Pers.
- Alfath, S. N., Ellianawati, & Sukisno, M. (2013). Pengembangan Media Blended Learning Berbasis Web. *Unnes Physics Education Journal*, 2(1), 1–6. Retrieved from <http://journal.unnes.ac.id/sju/index.php/upej>
- Amri, I. (2014). Pengembangan Media Pembelajaran E-Learning Berbasis Web Untuk Mata Kuliah Pendahuluan Fisika Inti, (1), 25–35.
- APJII. (2016). *Penetrasi Pengguna Internet di Indonesia 2016*. <https://apjii.or.id/survei2016>.
- Arsi, F., & Febrianti, K. V. (2014). Pengembangan Media Pembelajaran Fisika Berbasis Web untuk SMA Kelas X pada Pokok Bahasan Listrik Dinamis. In *Prosiding Seminar Nasional Fisika dan Pendidikan Fisika* (Vol. 5, pp. 33–42).
- Asyhari, A., & Diani, R. (2017). Pembelajaran Fisika Berbasis Web Enhanced Course: Mengembangkan Web-logs Pembelajaran Fisika Dasar 1. *Jurnal Inovasi Teknologi Pendidikan*, 4(1), 13–25. <https://doi.org/10.21831/jitp.v4i1.13435>
- Doyan, A., & Sukmantara, I. K. Y. (2014). Pengembangan Web Intranet Fisika Untuk Meningkatkan Penguasaan Konsep dan Kemampuan Pemecahan Masalah Siswa SMK. *Jurnal Pendidikan Fisika Indonesia*, 10(2), 117–127. <https://doi.org/10.15294/jpfi.v10i2.3348>
- Emzir. (2015). *Metodologi Penelitian*

- Pendidikan Kuantitatif dan Kualitatif*. Jakarta: PT Raja Grafindo Persada.
- Gunawan, I. (2014). Pengembangan Aplikasi Mobile Learning Fisika sebagai Media Pembelajaran Pendukung. *Jurnal Ilmiah Pendidikan Fisika Al-Biruni*, 3(1), 2.
- Habibi, G. A., & Kurniawan, A. (2014). Pengembangan Media Pembelajaran Berbasis Web Untuk Mengoptimalkan Hasil Belajar Siswa Pada Mata Pelajaran Fisika Materi Keseimbangan Benda Tegar Kelas Xi Sma Antartika Sidoarjo. *Universitas Negeri Surabaya*, 75.
- Hidayatullah, P., & Kawistrara, J. K. (2017). *Pemerograman WEB*. Bandung: Informatika Bandung.
- Irwandani, I. (2016). Potensi Media Dosial dalam Mempopulerkan Konten Sains Islam. *Tadris: Jurnal Keguruan Dan Ilmu Tarbiyah*, 1(2), 173–177.
- Putri, A. C. (2015). Pengembangan Media Pembelajaran Fisika Berbasis WEB Untuk Meningkatkan Adversity Quotient Peserta Didik. In *Prosiding Seminar Nasional Fisika*.
- S.Ramos, J. L., B.Dolipas, B., & B.Villamor, B. (2013). High Order Thinking Skills and Academic Performance in Physics of College Students : A Regression Analysis. *International Journal of Innovative Interdisciplinary Research*, 4, 48–60.
- Saregar, A. (2016). Pembelajaran Pengantar Fisika Kuantum dengan Memanfaatkan Media Phet Simulation dan LKM Melalui Pendekatan Saintifik: Dampak pada Minat dan Penguasaan Konsep Mahasiswa. *Jurnal Ilmiah Pendidikan Fisika Al-Biruni*, 5(1), 53–60.
<https://doi.org/10.24042/jpifalbiruni.v5i1.105>
- Saregar, A., Latifah, S., & Sari, M. (2016). Efektivitas Model Pembelajaran CUPS: Dampak terhadap Kemampuan Berpikir Tingkat Tinggi Peserta Didik Madrasah Aliyah Mathla'ul Anwar Gisting Lampung. *Jurnal Ilmiah Pendidikan Fisika Al-Biruni*, 5(2), 233–243.
- Saregar, A., & Sunarno, W. (2013). Eksperimen dan Demonstrasi Diskusi menggunakan Multimedia Interaktif ditinjau dari Sikap Ilmiah dan Kemampuan Verbal Siswa. *Jurnal Inkuiri*, 2(2), 100–113.
- Sugiono. (2013). *Metode Penelitian Kuantitatif, kualitatif dan R&D*. Bandung: Alfabeta.
- Sutedjo, B. (2002). *E-Education Konsep, Teknologi dan Aplikasi Internet Pendidikan*. Yogyakarta: ANDI.
- Ulya, S. H. N. U. N. (2013). Keefektifan Model Pembelajaran Guide Inquiry Berbasis Think Pair Share (TPS) dalam Meningkatkan Pemahaman Konsep Fisika Kelas XI SMA. *Unnes Physics Education Journal*, 2(2), 17–23. Retrieved from <http://journal.unnes.ac.id/sju/index.php/upej>
- Wahyudi, B. S. (2014). Pengembangan Bahan Ajar Berbasis Model Problem Based Learning Pada Pokok Bahasan Pencemaran Lingkungan Untuk Meningkatkan Hasil Belajar Siswa Kelas X Sma Negeri Grugujan Bondowoso. *Jurnal Pendidikan Dan Pengajaran*.
- Wahyudi, I. (2017). Pengembangan Program Pembelajaran Fisika SMA Berbasis E-Learning dengan Schoology. *Jurnal Ilmiah Pendidikan Fisika Al-Biruni*, 6(2), 187–199.
<https://doi.org/10.24042/jipfalbiruni.v6i2.1850>
- Yuberti. (2015). Pandangan Islam Terhadap Perkembangan Teknologi Komunikasi dan Informasi. *Jurnal Tekno-Pedagogi PPs Universitas Jambi*.